

bedrooms | upholstered beds | sofas

NEW ELEGANCE

FURNITURE

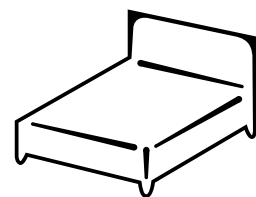

COLLECTION 2022

www.newelegance.pl

NEW ELEGANCE
FURNITURE

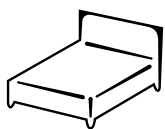

Product of the highest quality and unique designs. PREMIUM beds are distinguished by their deep quilting, which provides a spectacular 3D effect.

PREMIUM BED SYSTEM

Adjust the Premium bed to your needs.

8 steps to build your dream comfort.

1. APPEARANCE

Select the headboard quilting. You have 4 deeply quilted patterns to choose from.



headboard 22



headboard 33



headboard 66



headboard 77

2. HEIGHT

Select the height of the headboard. All headboards are available in two heights:

- 100 cm
- 120 cm

4. FABRIC

Choose the type and color of the fabric. Especially for you, we have selected a collection of several hundred fabrics. They will meet your expectations and the most demanding tastes in terms of color and quality. You can choose the fabrics in our showrooms or on www.newelegance.pl. Headboard 33 is also available in natural leather.

3. WIDTH

Select the bed width. Sizes from 140 to 200 cm are available. Not all headboard designs are available in all widths. This is due to the specific pattern and its transferability to the size of the headboard. Detailed dimensions of individual beds can be found on pages presenting separate models. Remember that the width of the bed is always greater than the width of the mattress.

5. BED BASE

Select the height of the bed base. Two heights to choose from:

- BED BASE C - 30 cm**
- BED BASE W - 36 cm**

The height of the bed base should be selected according to individual preferences and height. Beds with a higher base make it easier to get up in the morning.

bed base C

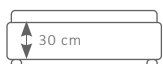

bed base W



6. LEG

Select the leg type. There are 4 legs available: metal legs B and 35 or wooden legs C and 29 in 10 colors. The colors of the wooden legs can be found on page 51 of the catalog

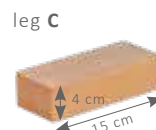
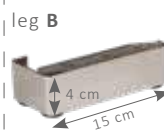

7. WITH OR WITHOUT A STORAGE?

Bed is available in several configurations of bed slats and storages. Choose the solution that suits you and your needs

bed without a storage



The bed is equipped with a solid support for the bed slats.

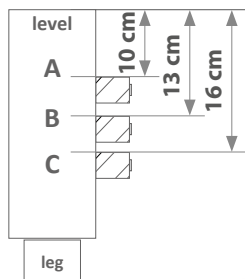

Bed gives the possibility of mounting the bed slats at 3 different heights. This allows you to better adjust the bed to the height of the mattress.

To make the bed complete, you need to choose proper bed slats. Full offer can be found on page 45 of the catalogue.



side opening lift up storage bed (left and right version available)

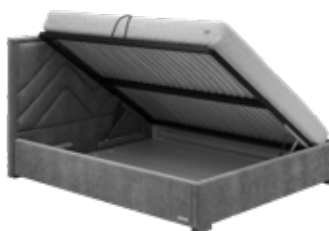

in the picture: right side opening version

front opening lift up storage bed



Two types of frames are available for side and front opening lift up storage beds: Standard frame or Comfort frame with side or front opening.

Mounting position of the frame in storage bed.

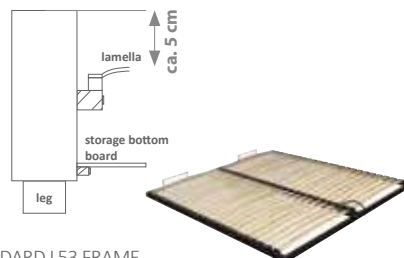

STANDARD L53 FRAME

- 24 flexible slats 53 mm wide
- spacing of 25 mm between lamellas
- metal frame with a cross-section of 40 x 30 mm
- bed slats height about 55 mm

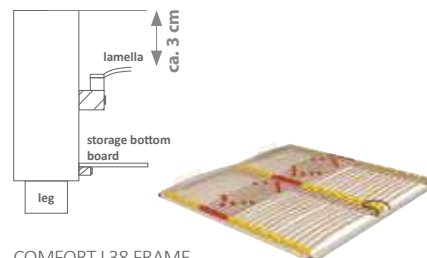

COMFORT L38 FRAME

- 30 flexible slats with a width of 38 mm
- - spacing of 25 mm between lamellas
- - a metal frame with a cross-section of 40 x 40 mm
- - bed slats height about 70 mm
- - 6 lamellas with hardness adjustment

Flexible duoflex holders ensure double depreciation and no so-called dead zone in the middle part of the bed slats frame.

8. MATTRESS

Choose a mattress for your bed. The complete range of mattresses on pages 42-44 of the catalog.

PREMIUM BED SYSTEM

HEADBOARD 77



In the picture: PREMIUM bed with headboard 77 with 120 cm height
Bed base W, leg 29 in color 24,
fabric BRU BRAVEHEART 09 GRIFFIN

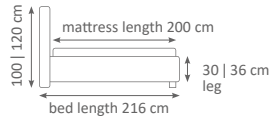
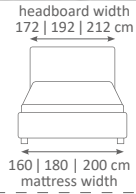

Depending on the size, the headboards have different arrangement of herringbone elements.
Drawings illustrate these differences and show the central point of the headboard.

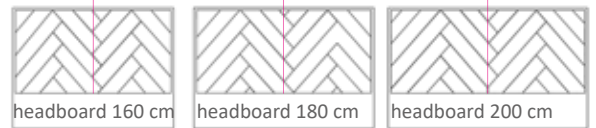

HEADBOARD 66



In the picture: PREMIUM bed with headboard 66 with 120 cm height
Bed base W, leg C in color 24 black,
fabric CHARLES CASTOR 03, DEKOMA

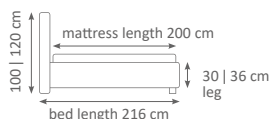
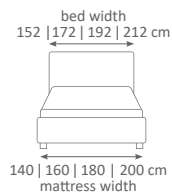

PREMIUM BED SYSTEM

HEADBOARD 22

N.E.



In the picture: PREMIUM bed with headboard 22 with 120 cm height, Bed base W, leg B, fabric MYSTIC 69, AQUACLEAN

headboard width
152 | 172 | 192 | 212 cm

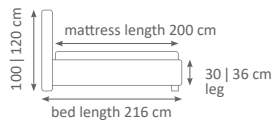

HEADBOARD 33



In the picture: PREMIUM bed with headboard 33 with 120 cm height, Bed base C, leg B, fabric SARGON 331, DEKOMA

headboard width
152 | 172 | 192 | 212 cm

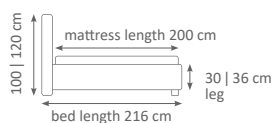
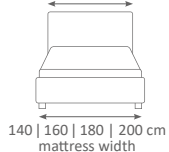

NEW ELEGANCE
FURNITURE

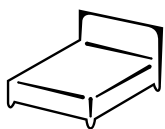

CONTINENTAL BED COLLECTION

The most popular form of upholstered bed in the world. The construction based on independent elements of the bed base, headboard and mattress gives you an unlimited choice. Besides the possibilities of various configurations, the convenience and practicality of this solution is an important aspect.

Adjust the bed from the CONTINENTAL BED collection to your needs. 5 steps to have a perfect bed.

1. THE BASE IS THE BASE

The most important part in continental beds is the bed base. Start with the choice of the bed base. It determines the size of the bed, its height and, most importantly, comfort and functionality. We offer 9 bed bases with different parameters.

A. STANDARD BED BASE

Solid construction made of chipboard and wood, felt filling with a weight of 500g, T25 foam with thickness of 1 cm, upholstery wadding 100g / m², cover made of jersey and upholstery fabric.

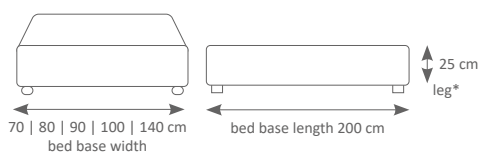

B. BONELL BED BASE

Solid construction made of chipboard and wood, Bonell spring (height 12 cm, 108 springs / 1 m²), felt filling with a weight of 500g, T25 foam with thickness of 2 cm, upholstery wadding 100g / m², cover made of jersey and upholstery fabric.

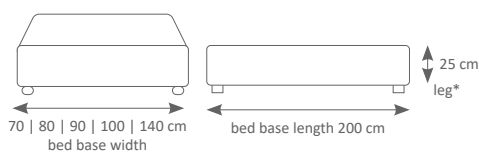

C. POCKET BED BASE

Solid construction made of chipboard and wood, Pocket spring (height 13 cm, 255 springs / 1 m²), felt filling with a weight of 500g, T25 foam with thickness of 2 cm, upholstery wadding 100g / m², cover made of jersey and upholstery fabric.

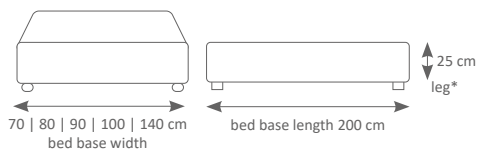

E. POCKET LUX BED BASE

Solid construction made entirely of wood. Pocket spring (height 13 cm, 255 springs / 1 m²), felt filling with a weight of 500g, T25 foam with the thickness of 2 cm, upholstery wadding 100g / m², cover made of jersey and upholstery fabric. Bed base E ensures lack of the so-called dead zone between two bases.

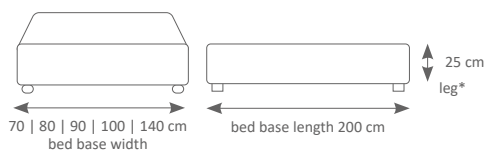

CONTINENTAL BED SYSTEM

P. BED BASE FOR FRONT OPENING LIFT UP STORAGE BED

Construction of bed base P is made of wood, lamellas: 20 flexible slats 53 mm wide, distance between lamellas 40 mm, T25 foam with the thickness of 1 cm, felt filling with a weight of 500 g, Fibertex



Internal dimensions of the storage for a 90 cm wide bed base 192x82x18 cm



Lifting up with a double mattress

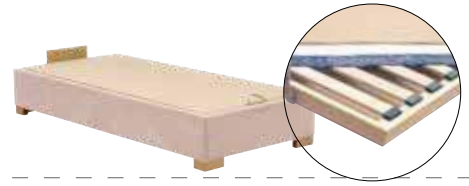
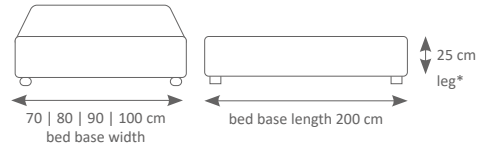

R. BED BASE FOR SIDE OPENING LIFT UP STORAGE BED

The continental bed base R guarantees high comfort, providing additional space under the mattress at the same time. The unique height of the bed base allows you to get the maximum height of the bed, and also makes the storage space huge. Construction of bed base R is made of wood, lamellas: 20 flexible slats 53 mm wide, distance between lamellas 40 mm, T25 foam with the thickness of 1 cm, felt filling with a weight of 500 g, Fibertex.



Large storage. Internal dimensions of the storage for a 90 cm wide bed base 192x82x23 cm



Lifting up bed base R with mattress. The basics are available in the left and right version

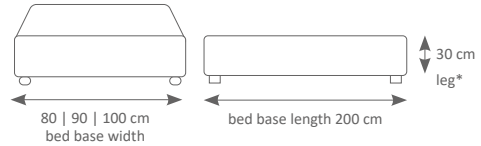

S. BED BASE WITH BEDDING DRAWER

The bed base S of continental beds is a solution that provides us with the use of a storage also in a situation where the exceptionally high and heavy mattress lies on the base. Construction of bed base S is made of wood, 20 wooden slats 55 mm wide, distance between slats 50 mm, T25 foam with the thickness of 1 cm, felt filling with a weight of 500 g, Fibertex.

Spacious drawer in the bed base. Internal dimensions of the drawer for the base width:
80 cm - 138x66x20 cm
90 and 100 cm - 138x76x20 cm



LEFT bed base



43 cm including the headboard. Be careful not to place wider elements directly next to the bed as this will limit the possibility of using the drawer.

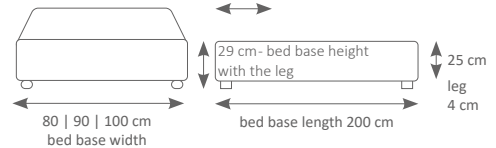

Only legs with a height of 4 cm in types 21, 24, 27, 30, 33 can be used with the bed base S (see next page).

M. FREE-STANDING BED BASE (ALL SIDES UPHOLSTERED)

The bed base M of continental beds has the same features as the bed base R. The only difference is the all-side upholstery, which allows the base to be placed each side into the interior. Construction of bed base M is made of wood, lamellas: 20 flexible slats 53 mm wide, distance between lamellas 40 mm, T25 foam with the thickness of 1 cm, felt filling with a weight of 500 g, Fibertex.



NOTE!!!
4 sides are upholstered. No possibility of fixing the headboard

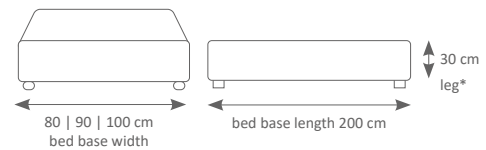

Z. BED BASE FOR FRONT OPENING LIFT UP STORAGE BED

Bed frame height 9 cm. Solid construction made of wood, underlay for springs made of chipboard of 1cm, Pocket spring (height 6 cm, 255 springs/1 m²), T25 foam with thickness of 1 cm, felt filling with a weight of 500g, cover made of jersey and upholstery.

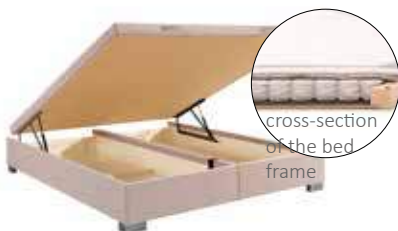

Large storage. Internal dimensions of the storage for the base with a width of 90- cm 192x82x22 cm



Frame holder No. 1
Frame holder No. 2 hidden under the mattress

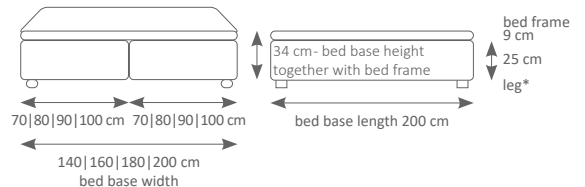

*available legs can be found on page 9

CONTINENTAL BED SYSTEM

2. APPEARANCE AND SIZE OF THE HEADBOARD

Select the type of headboard from among 20 patterns. The offer includes both simple headboards, such as headboard 100, as well as very decorative ones like 301. Practical solution in our offer are SMART headboards, in which we used an unconventional wall mounting solution without fixing the headboard with the base. Height is a choice according to individual needs and housing possibilities. The offer includes both compact headboards types 201 or 202 as well as huge ones like type 700. The size range is very large. For size details see the presentation of each headboard on the following pages.

3. FABRIC

Select the type and colour of the fabric. We have selected especially for you a collection of several hundred of fabrics, which, in terms of colour and quality meet the expectations of the most demanding tastes. You can choose fabrics in showrooms or on website.

4. LEGS

GLIDER



GLIDER

LEGS FOR CONTINENTAL BEDS WITH BED BASE A, B, C, D, E, F, M, P, R, Z



No 21 height 4 cm width 6 cm depth 6 cm	No 22 height 6 cm width 6 cm depth 6 cm	No 23 height 10 cm width 6 cm depth 6 cm	No 24 height 4 cm ø 6 cm	No 25 height 6 cm ø 6 cm	No 26 height 10 cm ø 6 cm	No 27 height 4 cm width 15 cm depth 10 cm	No 28 height 6 cm width 15 cm depth 10 cm	No 29 height 10 cm width 15 cm depth 10 cm	No 33 height 4 cm width 15 cm depth 10 cm	No 34 height 6 cm width 15 cm depth 10 cm	No 35 height 10 cm width 15 cm depth 10 cm
---	---	--	---------------------------------------	---------------------------------------	--	---	---	--	---	---	--

WOODEN LEGS WITH COLOURING POSSIBILITY FOR CONTINENTAL BEDS (BED BASES A, B, C, E, P)



No 46 height 15 cm width 8 4 cm depth 8 4 cm	No 50 height 15 cm width 9 cm depth 9 cm	No 51 height 15 cm ø 12 cm	No 52 height 15 cm ø 9 cm
--	--	---	--

PLINTHS FOR CONTINENTAL BEDS



COLOURINGS OF WOODEN LEGS



beech lacquer 01	oak oiled 11	oak lacquer 28	white 26	alder 21	alder 22	alder 23	black 24	silver 23	gold 27
------------------	--------------	----------------	----------	----------	----------	----------	----------	-----------	---------

5. MATTRESS

In our offer you will find 7 mattress designs with different utility parameters. A detailed description of the mattresses can be found on pages 42-44 of the catalogue. Each mattress is available in two versions of the sides finish. STANDARD- the sides made of breathable fabric with high air permeability. LUX- sides made of the same fabric as the bed base and headboard which gives the effect of uniformity of the whole product.

Mattress ELITTE 27



one-sided | medium firm | height 27 cm

Mattress ELITTE 21



one-sided | medium firm | height 21 cm

Mattress ROSA



one-sided | medium firm | height 19 cm

Mattress BOSS



double-sided | firm | height 20 cm

mattress cover



Mattress fabric to choose from

Mattress FINEZIA



one-sided | medium soft | height 18 cm

Mattress RUBIN



double-sided | firm | height 18 cm

Mattress DALIA SMART



double-sided | firm | height 18 cm

Mattress TOPPERS



side of the mattress made of upholstery fabric (as at the headboard and bed base)

SAMPLE BEDS HEIGHTS

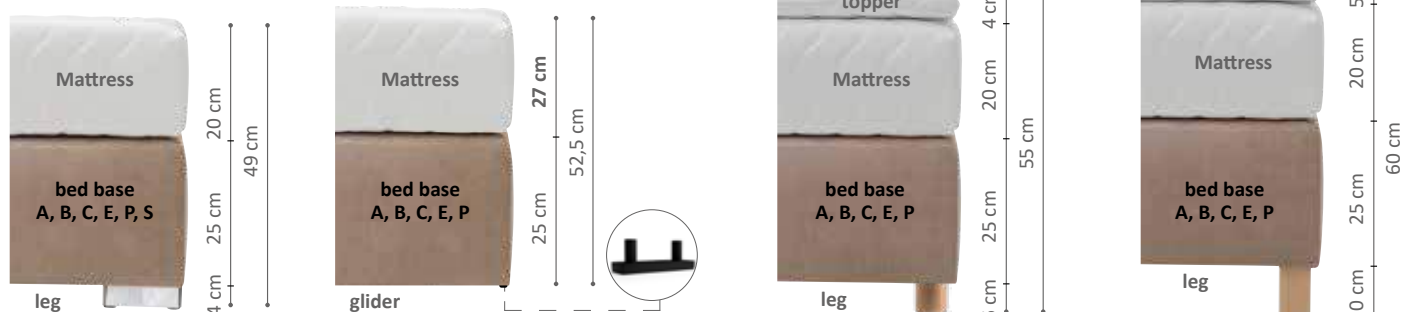

CONTINENTAL BED SYSTEM

130 cm high headboards are fixed to the bed base.
The headboards of 150 and 180 cm, are fastened only to the wall.

N.E.

Headboard 700



In the picture: CONTINENTAL bed with headboard 700 with wooden frame in color 28, bed base E, headboard height 180 cm, Plinth in oak lacquer 28 color, fabric BRU BOLSHOI 33 HUNTER



Headboard 700 with a chrome metal frame

Headboard 700 with a wooden oak lacquer 28 frame

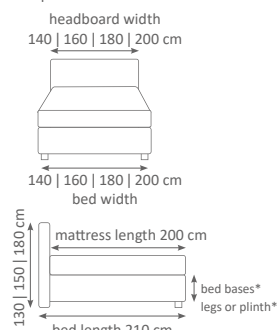

Headboard 505



In the picture: CONTINENTAL bed with headboard 505, bed base B headboard height 118 cm Leg 25 in 24 color fabric CROWN VELVET 35, RIDEX



There is a possibility to order a headboard with down filling. 100% natural down for your comfort.

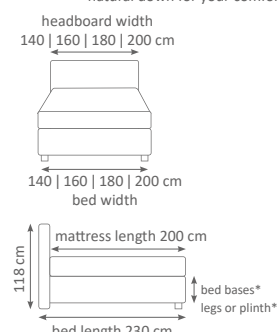

Headboard 507



In the picture: CONTINENTAL bed with headboard 507, bed base P, headboard height 115 cm, Leg 34 fabric CROWN VELVET 109, RIDEX

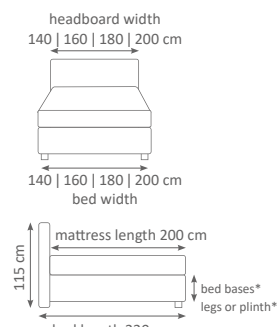

CONTINENTAL BED SYSTEM

Headboard SMART



In the picture: CONTINENTAL bed with headboard SMART 5, bed base P, Leg 34 fabric CROWN VELVET 30, RIDEX



headboard No 1



headboard No 4



headboard No 5

headboard width
140 | 160 | 180 | 200 cm



140 | 160 | 180 | 200 cm
bed width

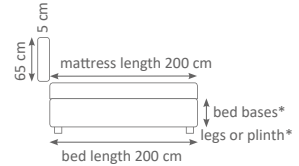

Headboard 606



In the picture: CONTINENTAL bed with headboard 606, bed base B, headboard height 125 cm Leg 28 in 28 color fabric VELIERO 27 FARGOTEX

headboard width
140 | 160 | 180 | 200 cm

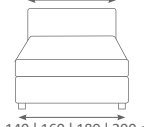

140 | 160 | 180 | 200 cm
bed width

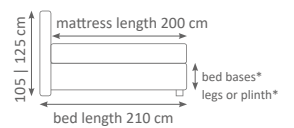

Headboard 402



In the picture: CONTINENTAL bed with headboard 402, bed base C headboard height 125 cm Leg 28 in 26 white color fabric SAMUI 23, ARTEX

headboard width
140 | 160 | 180 | 200 cm

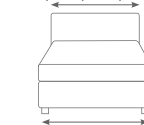

140 | 160 | 180 | 200 cm
bed width

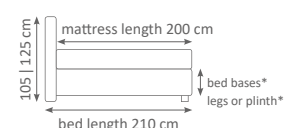

CONTINENTAL BED SYSTEM

Headboard 201



In the picture: CONTINENTAL bed with headboard 201, bed base Z, headboard height 125 cm, Leg 34 fabric BELLAGIO 213 AC, AQUACLEAN

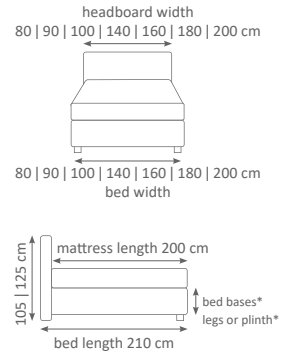

Headboard 900



In the picture: CONTINENTAL bed with headboard 900, bed base B, headboard height 165 cm, Leg 28 in O1 color fabric GENOVA 600, SYMPHONY

Two types of studs to choose from

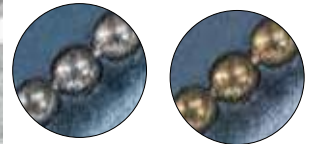

silver

gold

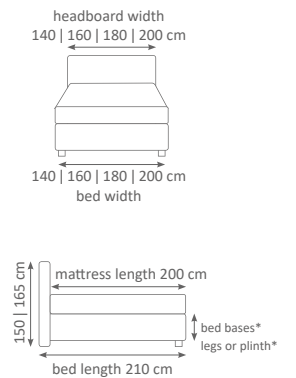

Headboard 301



it is possible to make a bed with crystals

In the picture bed KONTYNENTALNE z headboardm 301, bed base C, headboard height 125 cm, Leg 34, fabric SPIRIT 106 AQUACLEAN

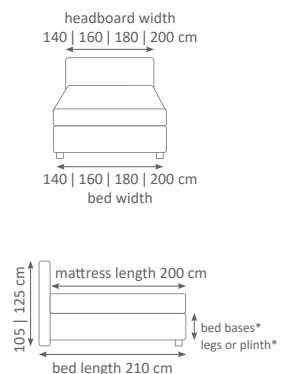

CONTINENTAL BED SYSTEM

Headboard 102



In the picture: CONTINENTAL bed with headboard 102, bed base B, headboard height 125 cm, leg 25.

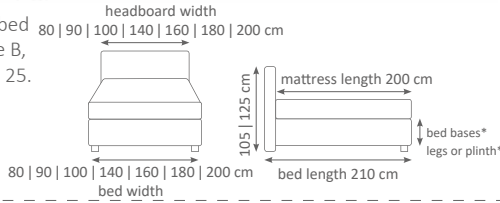

Headboard 202



In the picture: CONTINENTAL bed with headboard 202, bed base B, headboard height 125 cm, leg 25.

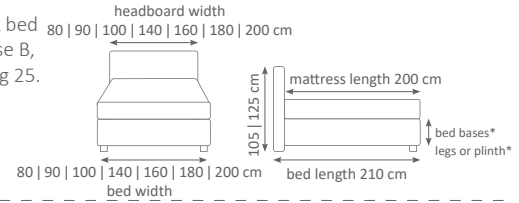

Headboard 100



In the picture: CONTINENTAL bed with headboard 100, bed base B, headboard height 125 cm, leg 25.

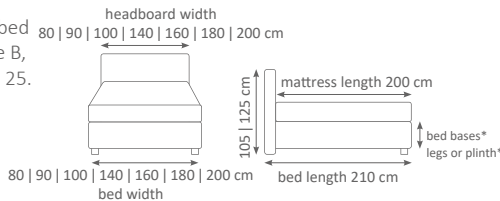

Headboard 101



In the picture: CONTINENTAL bed with headboard 101, bed base B, headboard height 125 cm, leg 25.

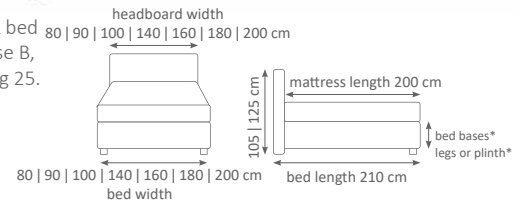

Headboard 105



In the picture: CONTINENTAL bed with headboard 105, bed base B, headboard height 125 cm, leg 25.

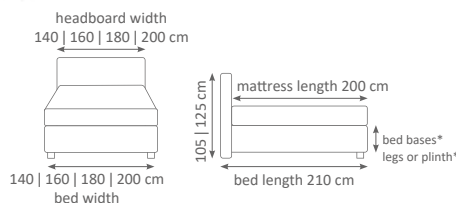

Headboard 400



In the picture: CONTINENTAL bed with headboard 400, bed base B, headboard height 125 cm, leg 25.

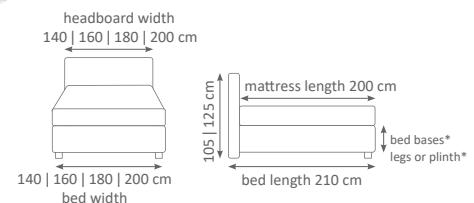

NEW ELEGANCE
FURNITURE

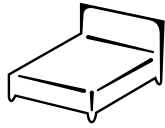

UPHOLSTERED BEDS

Upholstered beds from the N.E. 2020/2021 collection.

6 steps to suit them to your needs.

1. APPEARANCE

Upholstered beds from our offer are already completed proposals. That means that, unlike e.g. Continental, Premium or Mini Maxi beds, each bed has most of the elements already included in the specification and they are not changeable (headboard, bed frame, etc.). However, you can choose the mattress and functions that your bed should have.



2. FABRIC

Choose the type and color of the fabric. Especially for you, we have selected a collection of several hundred fabrics. They will meet all expectations and the most demanding tastes. You can choose the fabrics in our showrooms or on www.newelegance.pl.

3. DIMENSIONS

Choose a model that suits your needs not only in terms of appearance but also in terms of external dimensions. Remember that some of the headboards are larger and extend significantly beyond the contour of the mattress and the bed body.

4. LEG

Most beds have 3 different legs to choose from. There are also some that have more, like Tiffany. Full offer you can see on page 51 of the catalogue. All wooden legs can be ordered in any color from the colouring list below.

Available leg variants

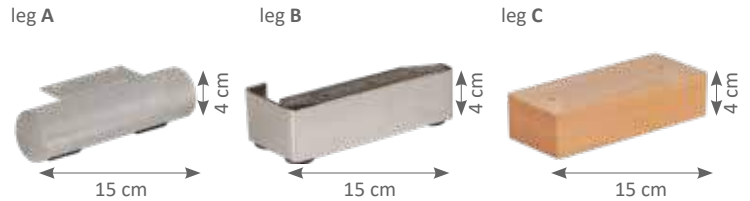

plinth F



plinth colors on page 51

5. WITH OR WITHOUT A STORAGE?

Additional bed functions and special equipment. The bed is available in several configurations of bed slats and storages. Choose the solution that suits you and your needs

bed **without storage**



The bed is equipped with a solid support for the bed slats.

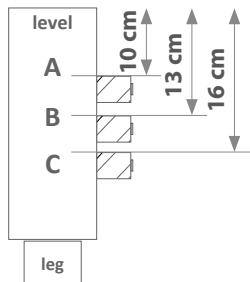

Bed gives the possibility of mounting the bed slats at 3 different heights. This allows you to better adjust the bed to the height of the mattress.



To make the bed complete, you need to choose proper bed slats. Full offer can be found on page 45 of the catalogue.

front **opening lift up storage bed**



Two types of frames are available for storage beds: Standard frame or Comfort frame with front opening.

Mounting position of the frame in storage bed.

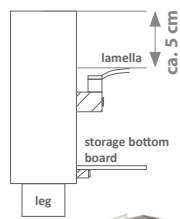

STANDARD L53 FRAME

- 24 flexible slats 53 mm wide
- spacing of 25 mm between lamellas
- metal frame with a cross-section of 40 x 30 mm
- bed slats height about 55 mm

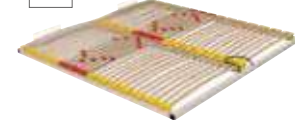
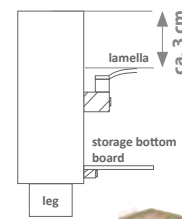

COMFORT L38 FRAME

- 30 flexible slats with a width of 38 mm
- spacing of 25 mm between lamellas
- a metal frame with a cross-section of 40 x 40 mm
- bed slats height about 70 mm
- 6 lamellas with hardness adjustment

Flexible duoflex holders ensure double depreciation and no so-called dead zone in the middle part of the bed slats frame.

6. MATTRESS

Match the mattress to your bed. Complete offer of mattresses on pages 42-44 of the catalogue. You will find 7 mattress models in various types of covers there. Our mattresses are of the highest quality, which ensures comfortable and healthy sleep. You can also find additional mattress toppers in our offer.

BOHO
upholstered bed



In the picture, a bed in a fabric: **SPECTRA 01, FARGOTEX**

ATTENTION!

In a bed with a container, the foldable headboard requires the use of Mattress with a maximum height of 22 cm. The taller Mattress will make it difficult to tilt the movable part of the headboard. Standard equipment includes 2 sliding headrests. The bedside table STANDARD from the collection of complementary furniture N.E.2021 fits perfectly with the BOHO bed. For more chests of drawers and bedside tables, see page 41 of the catalog or visit www.newelegance.pl

STANDARD bedside table

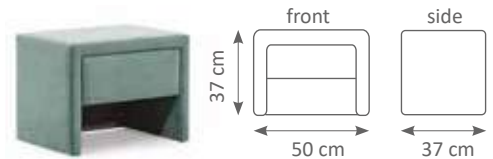

Dimensions of upholstered bed BOHO

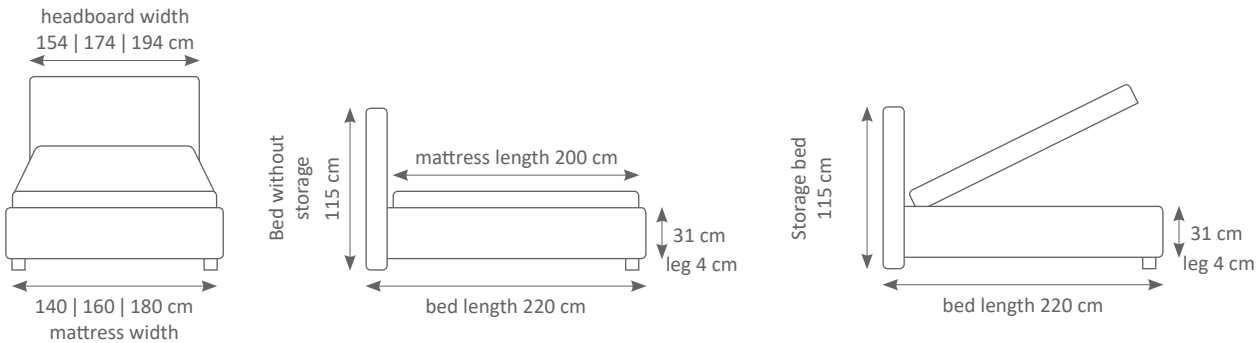

NEW

N.E.

NORD

upholstered bed



In the picture, a bed in a fabric: **CLOUD 91, DAVIS**

Additional equipment

The bedside table Nord from the N.E.2021 collection of complementary furniture fits perfectly with the NORD bed. More bedside tables and chests of drawers can be found on page 41 of the catalog or at www.newelegance.pl

NORD
(push and pull)

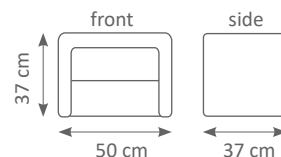

Dimensions of upholstered bed NORD

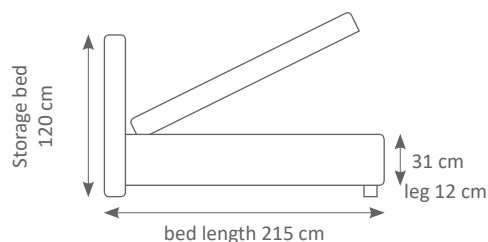
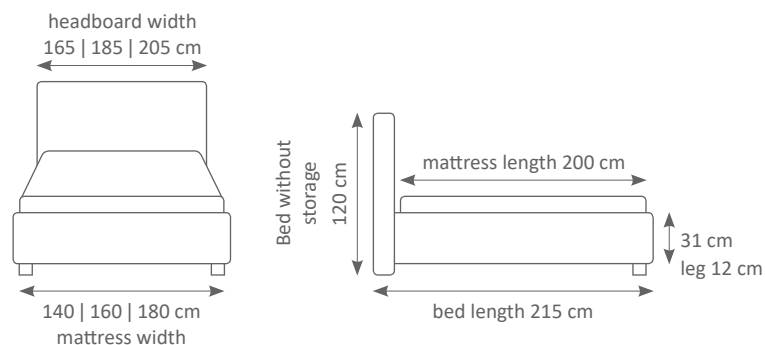

LAYLA
upholstered bed



In the picture, a bed in a fabric: **CLAUDE 09, FARGOTEX**

Additional equipment

The LAYLA bedside table from the N.E.2021 collection of complementary furniture fits perfectly with the LAYLA bed. For more chests of drawers and bedside tables, see page 41 of the catalog or visit www.newelegance.pl

A sliding headrest is optional equipment

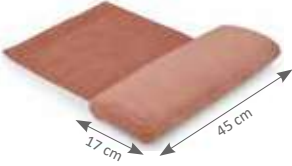

LAYLA bedside table

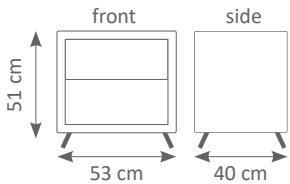

Dimensions of upholstered bed LAYLA

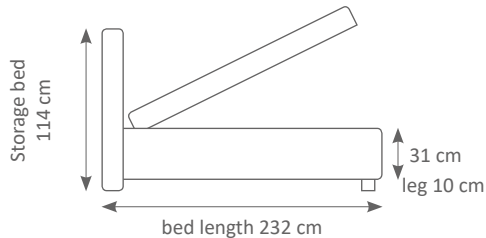
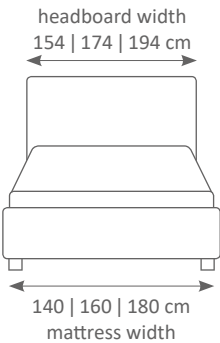

NEW

N.E.

MAYA

upholstered bed



In the picture, a bed in a fabric: **JASPIS 51, ARTEX**

Additional equipment

The bedside table Continental D from the N.E.2021 collection of complementary furniture fits perfectly with the MAYA bed. For more bedside tables and chests of drawers see page 41 of the catalog or see page

CONTINENTAL D

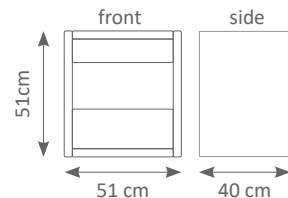

Dimensions of upholstered bed MAYA

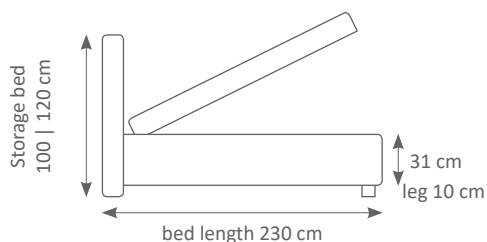
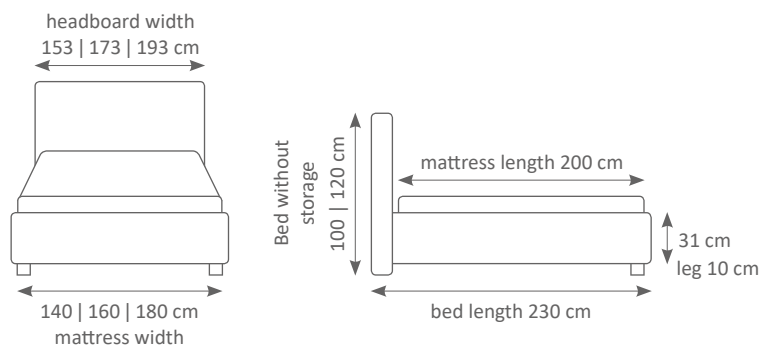

UPHOLSTERED BEDS

BELLY



In the picture upholstered bed BELLY, leg 29 in black, fabric TOPTXTIL AURORA 2495

Available leg variants
leg 35 leg 29



colourings of leg 29 on page 51

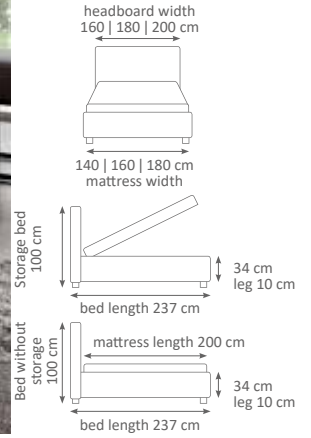

BOLSENA



In the picture upholstered bed BOLSENA, fabric BRU FIBREGUARD RANCH 12

bedside table BOLSENA

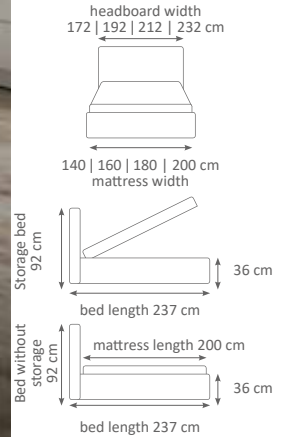
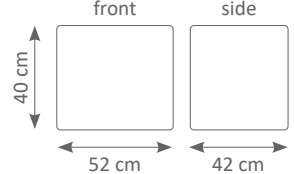

BERGAMO



In the picture upholstered bed BERGAMO, leg B, skóra natóralna MODENA 601

Do łózka with storage istnieje możliwość zamówienia stelaża z funkcją elektrycznego podnoszenia sterowanego pilotem.

Available leg variants

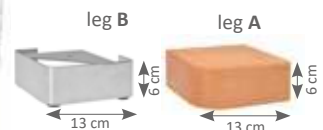

wybarwienia nóżki 29 na stronie 51

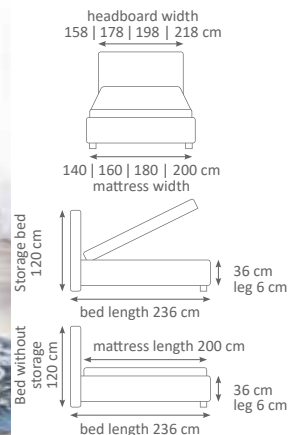

UPHOLSTERED BEDS

SoftLoft



In the picture upholstered bed SoftLoft, fabric TOP TEXTIL, MAGIC VELVET 2217

bedside table
height 46 cm
width 53 cm
depth 37 cm

chest of drawers
(glass top)
height 80 cm
width 108 cm
depth 55 cm

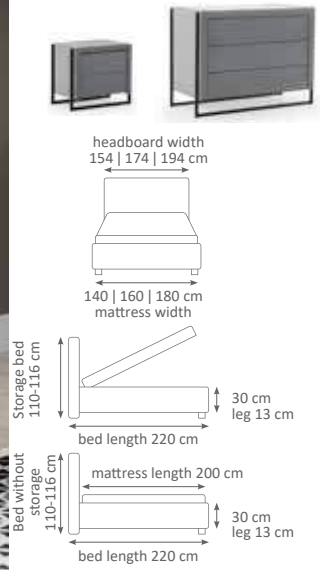

MONACO



There is a possibility to order a headboard with down filling. 100% natural down for your comfort.

In the picture upholstered bed MONACO, leg B, fabric BRU, LECH O2 NAVY

It is possible to order a bed slats with the remote-controlled electric lifting function.

Available leg variants

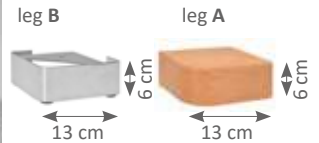

colourings of leg A on page 51

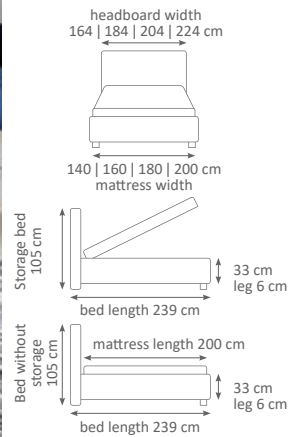

HAVANA



Available leg A | B | C on page 15



it is possible to make a bed with crystals

bedside table HAVANA

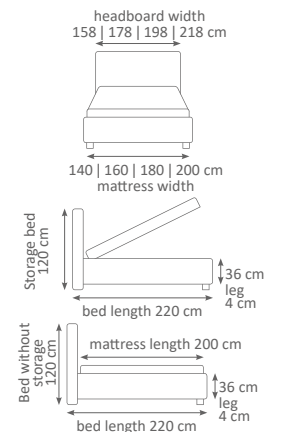
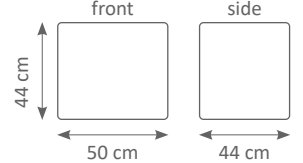

In the picture upholstered bed HAVANA, leg A, fabric GENOVA 601, SYMPHONY

UPHOLSTERED BEDS

PORTO

Available leg **A** | **B** | **C** on page 15



In the picture upholstered bed PORTO, leg B, fabric BELLAGIO AC 82, AQUACLEAN

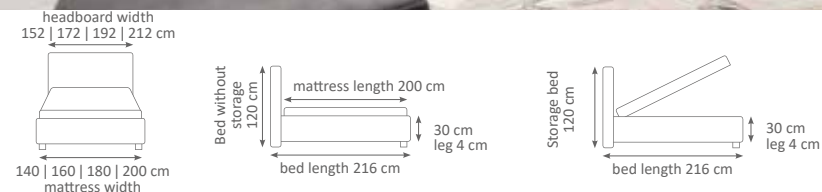

The headboards with smooth movement of the backrests, easily creating perfect conditions for reading and relaxation in bed.



WAVE



In the picture upholstered bed WAVE, leg A, fabric SCOT 32, DEKOMA

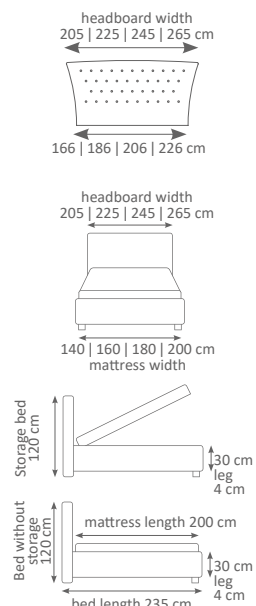

APOLLO S

Available leg **A** | **C** | **F** on page 15



In the picture upholstered bed APOLLO S, leg A, fabric MAGIC VELVET 2217, TOP TEXTIL

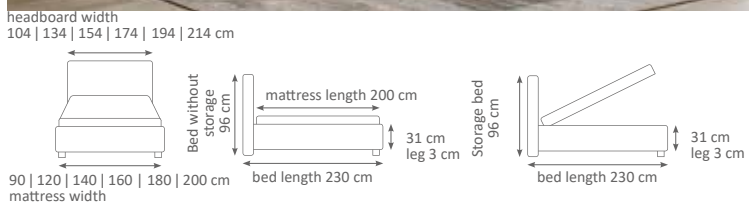

KALIPSO

Available leg **A** | **C** on page 15



In the picture upholstered bed KALIPSO, wooden leg C srebrna 23, artificial leather LONG ISLAND 12, FARGOTEX

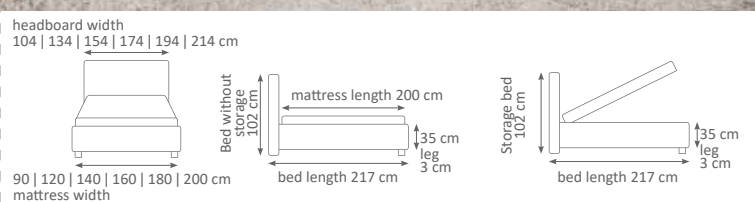

UPHOLSTERED BEDS

VIGO



In the picture upholstered bed VIGO,
fabric MATRIX 16, S.I.C.

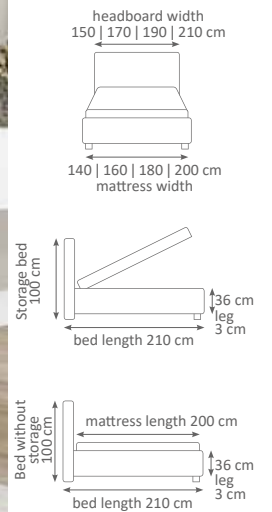

leg colouring on page 51

PRINCESSA



In the picture upholstered bed PRINCESSA,
leg 50 in silver 23,
fabric VENUS VELVET 2929, TOP TEXTIL

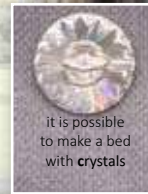

it is possible
to make a bed
with crystals

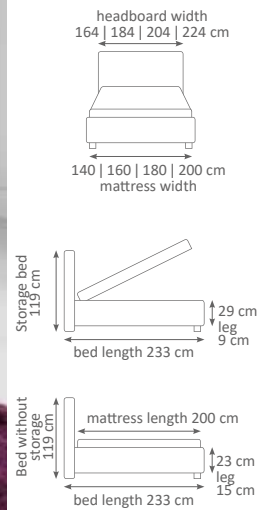

leg colouring on page 51

ROMA



In the picture upholstered bed ROMA, leg B,
fabric SPIRIT 52, AQUACEAN

Available leg B | C on page 15

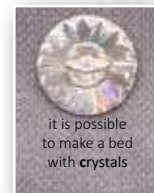

it is possible
to make a bed
with crystals

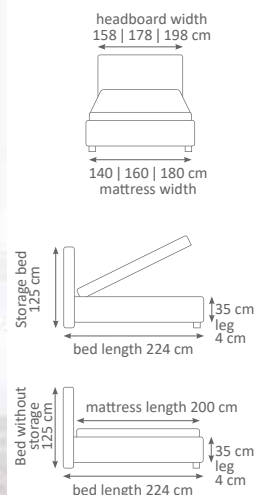

NEW ELEGANCE
FURNITURE

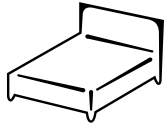

The Mini Maxi bed system has been one of the bestsellers on the market for many years so far. Each year we present new designs, which combined with the huge possibilities of adjusting the dimensions to different rooms, enable you to personalize your own bedroom.

MINI MAXI BED SYSTEM

Suit the bed from the MINI MAXI collection to your needs.

7 steps to build your dream comfort.

1. APPEARANCE

Choose the look of the headboard. There are 10 models to choose from. Each one has a different quilting pattern. It is possible to order a bed without a headboard (only body C, G, W)

2. DIMENSIONS

The name of the MINI MAXI system comes from the idea that each headboard model can be obtained in the mini and maxi version. That's why we have so many size variants.

3. BED FRAME

The MINI MAXI bed range has 4 different bed frames to choose from. C *, G * and W ** bodies also available without headboard.

bed frame C (straight edge)



bed frame G (rounded edge)



bed frame H (joined 45°)

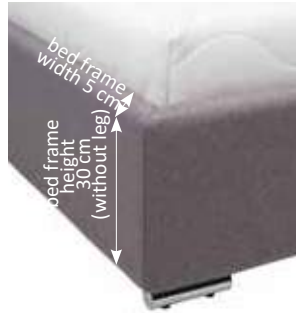

bed frame W** (straight edge, glider)

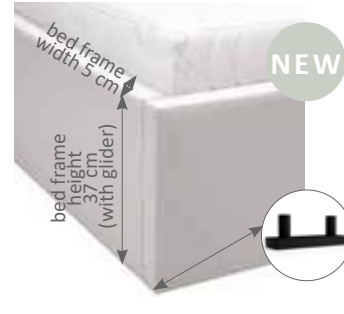

* Bed frame C and G in version without headboard, available with legs or gliders. Only available on the legs in the headboard version

** bed frame W only available with a glider.

4. LEG

Select the leg type. There are metal legs A, B and 35 and wooden legs C and 29. Plinth E is available in 2 versions - wooden and chromed. Wooden elements are available in 10 colors (see page 51 of the catalog).

Plinth E (only available with C bed frame)



leg A

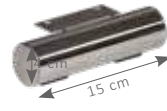

leg B

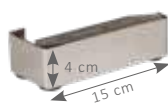

leg C

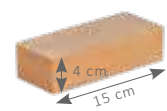

leg 29



leg 35

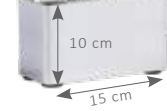

5. STITCHES OF THE BED FRAMES

Each bed frame can be ordered in 3 stitching patterns

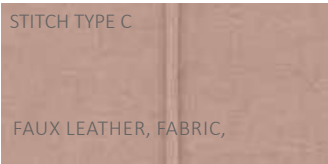
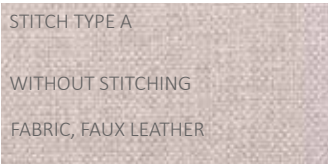

6. WITH OR WITHOUT STORAGE?

Additional bed functions and special equipment. The bed is available in several configurations of bed slats and storages. Choose the solution that suits you and your needs.

bed without storage



The bed is equipped with a solid support for the bed slats.

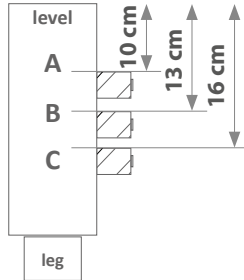

Bed gives the possibility of mounting the bed slats at 3 different heights. This allows you to better adjust the bed to the height of the mattress.

To make the bed complete, you need to choose proper bed slats. Full offer can be found on page 45 of the catalogue.



front opening lift up storage bed



Two types of frames are available for storage beds: Standard frame or Comfort frame with front opening. Mounting position of the frame in storage bed.

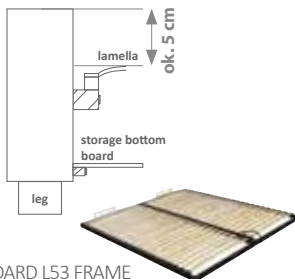

STANDARD L53 FRAME

- 24 flexible slats 53 mm wide
- spacing of 25 mm between lamellas
- metal frame with a cross-section of 40 x 30 mm
- bed slats height about 55 mm

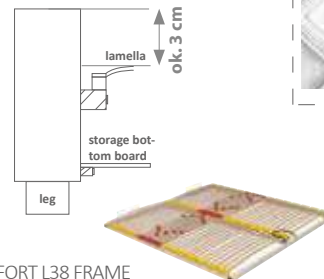

COMFORT L38 FRAME

- 30 flexible slats with a width of 38 mm
- spacing of 25 mm between lamellas
- a metal frame with a cross-section of 40 x 40 mm
- bed slats height about 70 mm
- 6 lamellas with hardness adjustment

Flexible duoflex holders ensure double depreciation and no so-called dead zone in the middle part of the bed slats frame.

7. MATTRESS

Choose Mattress for your bed. The complete Mattress range on pages 42-44 of the catalog.



MINI MAXI BED SYSTEM

Headboard 3700



In the picture: MINI MAXI bed with headboard 3700, bed frame C, stitch C, headboard height 120 cm
Plinth E in 28 color
fabric MONOLITH 92, DAVIS

bed frame C, G, H i W – headboard width
152 | 172 | 192 | 212 cm

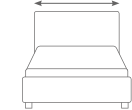

140 | 160 | 180 | 200 cm
mattress width

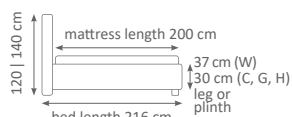

headboard 3700
with chromed plinth and chromed metal border



chromed
metal plinth

Headboard 3700
with plinth and wooden oak lacquer 28 border



wooden painted
lacquered plinth



decorative wooden plinth E. Available colourings on page 51

Headboard 5700



In the picture: MINI MAXI bed with headboard 5700, bed frame C, stitch A, headboard height 115 cm
Leg 35
fabric BRAVEHEART 01, FIBREGUARD

bed frame C, G, H i W – headboard width
160 | 180 | 200 cm

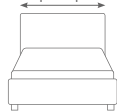

140 | 160 | 180 cm
mattress width

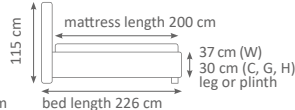

Headboard 3100



In the picture: MINI MAXI bed with headboard 3100, bed frame F, stitch A, headboard height 120 cm
Leg B
Faux leather Long Island 01, FARGOTEX

bed frame C, G, H i W – headboard width
152 | 172 | 192 | 212 cm

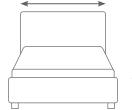

140 | 160 | 180 | 200 cm
mattress width

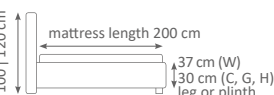

Headboard 3000



In the picture: MINI MAXI bed with headboard 3000, bed frame G, stitch A, headboard height 120 cm
Leg B
fabric SARGON, DEKOMA

bed frame C, G, H i W – headboard width
152 | 172 | 192 | 212 cm



140 | 160 | 180 | 200 cm
mattress width

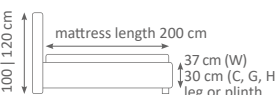

MINI MAXI BED SYSTEM

Headboard 2700



In the picture: MINI MAXI bed with headboard 2700, bed frame C, stitch C, headboard height 120 cm Leg B fabric TOWN 23, DAVIS

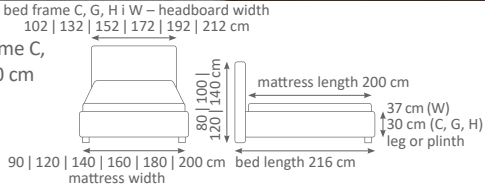

Headboard 2100



In the picture: MINI MAXI bed with headboard 2200, bed frame C, stitch A, headboard height 100 cm, Leg B fabric MYSTIC 03, AQUACLEAN

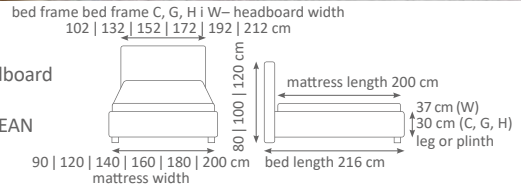

Headboard 2103



In the picture: MINI MAXI bed with headboard 2103, bed frame A, stitch B, headboard height 120 cm, Leg A fabric BELLAGIO 13, AQUACLEAN

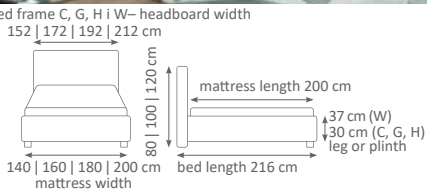

Headboard 2102



In the picture: MINI MAXI bed with headboard 2102, bed frame C, stitch B, headboard height 80, 100, 120 cm, leg A, fabric BRAVEHEART 01, FIBREGUARD

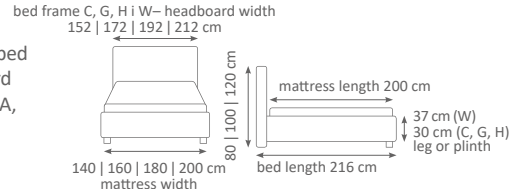

Headboard 2300



In the picture: MINI MAXI bed with headboard 2300, bed frame C, stitch A, headboard height 120 cm Leg B fabric NEW PALERMO 3, PIK

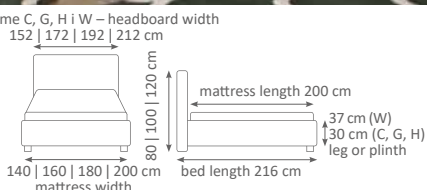

Headboard 2101



In the picture: MINI MAXI bed with headboard 2101, bed frame C, stitch B, headboard height 80 cm, leg A,

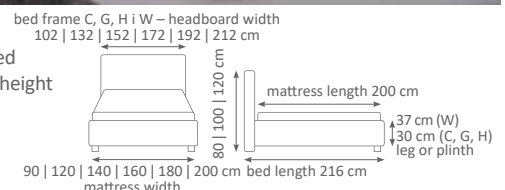

LOFT KARMEL BEDROOM



Available colourings of LOFT KARMEL: karmel oak + black metal. Bed headbord is available only with fabric: PRESTON 100, DAVIS

Opening the door and sliding drawers in the system **push and pull**



bedside table LKST-2S
width 45
height 48 cm
depth 40 cm



bed with storage LKLP
width 147 | 167 | 187 cm
height 112 cm
depth 215 cm



bed without storage LKL
width 147 | 167 | 187 cm
height 112 cm
depth 215 cm

NEW



chest of drawers LKKO-3S
width 90 cm
height 85 cm
depth 46 cm



wardrobe LKSZ-2DP
with shelves and a bar
width 90 cm
height 200 cm
depth 60 cm



wardrobe LKSZ-2D with bar
width 90 cm
height 200 cm
depth 60 cm



open wardrobe LKRE
width 106 cm
height 163 cm
depth 50 cm

HORIZONTAL WALL BED



NOTE! In order for the wall bed to function properly, mattresses taller than 21 cm are not allowed, their weight should not exceed 20 kg for a mattress 90 cm / 25 kg for 120 cm / 30 kg for 140 cm.

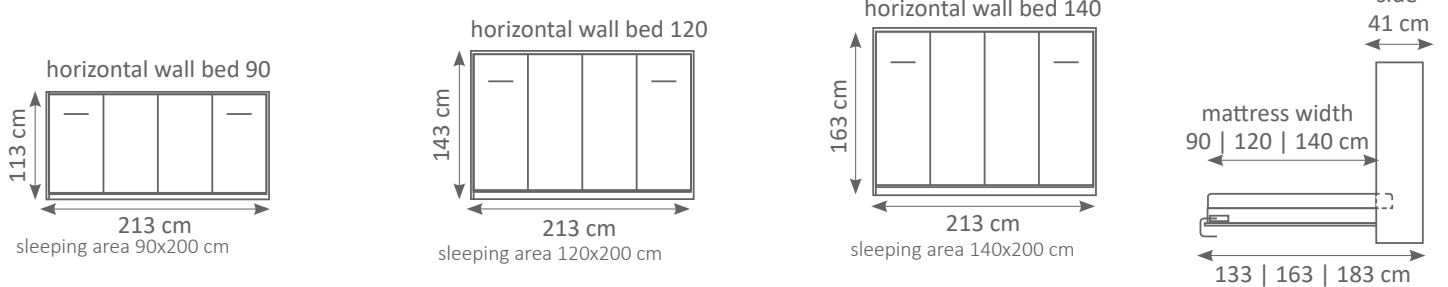

DIMENSIONS AND MODELS OF ADDITIONAL ELEMENTS

wardrobe S with hanger, drawers and bedside table

wardrobe P with shelves

wardrobe W with hanger

regal R with shelves level raiser N

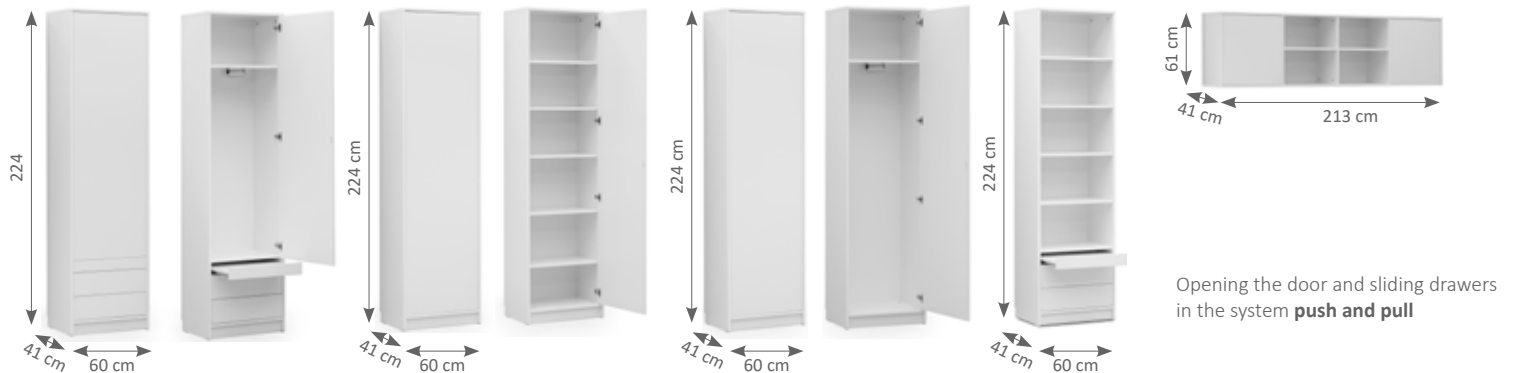

VERTICAL WALL BED



Vertical wall bed 90

Vertical wall bed 120

Vertical wall bed 140

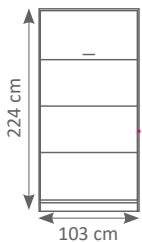

sleeping area 90x200 cm

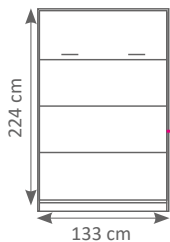

sleeping area 120x200 cm

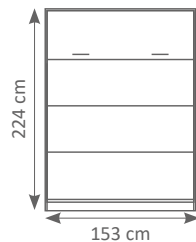

sleeping area 140x200 cm

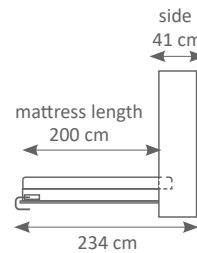

NOTE! In order for the wall bed to function properly, mattresses taller than 21 cm are not allowed, their weight should not exceed 20 kg for a mattress 90 cm / 25 kg for 120 cm / 30 kg for 140 cm.



AVAILABLE COLOURINGS OF WALL BED

WHITE MAT



BLACK | LANCELOT OAK



LIGHT SONOMA OAK



HIKORA OAK



LOFT bedroom, living room



Bed headboard is available only with fabric AVILLA 26, FIBERO

Available colourings of LOFT: Lancelot oak + black metal

mirror LFLU-100
(with imitation of frame)
width 100 cm
height 60 cm

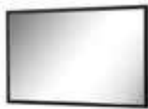

bedside table LFST-25
width 50 cm
height 45 cm
depth 40 cm



chest of drawers LFKO-6S
width 110 cm
height 84 cm
depth 42 cm



open wardrobe LFRE
width 106 cm
height 163 cm
depth 50 cm



wardrobe with swing doors
LFSZ 2D left
width 104 cm
height 204 cm
depth 60 cm



wardrobe with swing doors
LFSZ 2D right
width 104 cm
height 204 cm
depth 60 cm



wardrobe with 4 swing doors
LFSZ 4D with mirrors
width 204 cm
height 204 cm
depth 60 cm



wardrobe with 4 swing doors
LFSZ 4D
width 204 cm
height 204 cm
depth 60 cm



move the mirror freely
as you wish

dressing table with mirror
LFTOL
width 104 cm
height 114 cm
depth 48 cm



pouf
LFPU
width 140 cm
height 54 cm
depth 44 cm



bed without storage LFL
width 150 | 170 | 190 cm
height 103 - 109 cm
depth 216 cm



bed with storage LFLP
width 150 | 170 | 190 cm
height 103 - 109 cm
depth 216 cm



desk LFBI
width 124 cm
height 76 cm
depth 60 cm



console/dressing table LFTO
width 104 cm
height 76 cm
depth 42 cm



Available colourings of LOFT: Lancelot oak + black metal



chair LFKR
width 44 cm
height 94 cm
depth 62 cm
vertical



chair LFKR
width 44 cm
height 94 cm
depth 62 cm
quilt



display cabinet LFWI-2D1S
(universal display unit right / left, one-sided lighting always on the left)
width 60 cm
height 185 cm
depth 47 cm
(SITE LIGHTING IS STANDARD EQUIPMENT)



display cabinet LFWI-4D2S
(two-sided lighting)
width 90 cm
height 185 cm
depth 47 cm



TV cabinet LFTV
width 154 cm
height 45 cm
depth 44 cm



Chest of drawers LFKO-2D7S
width 160 cm
height 90 cm
depth 47 cm



Chest of drawers LFKO-4D4S
width 190 cm
height 90 cm
depth 47 cm



mirror LFLUR-100
(with metal frame | horizontal installation only)
width 100 cm, height 60 cm



mirror LFLUR-150
(with metal frame | horizontal installation only)
width 150 cm | height 70 cm



coffee table LFLA
width 110 cm
height 55 cm
depth 60 cm



table LFST-170
width 170 cm
height 76 cm
depth 90 cm



table LFST-130
width 130 cm
height 76 cm
depth 80 cm

GlassLoft bedroom



Bed headboard is available only with fabric DAZZA 13, FARGORTEX

Available colourings of GlasLoft: Berdaux oak + black metal



mirror **GLLU-100**
(with imitation of frame)
width 100 cm
height 60 cm

move the mirror freely
as you wish



dressing table **GLTOL**
with mirror
width 104 cm
height 114 cm
depth 48 cm



Chest of drawers **GLKO-6S**
with glass
width 120 cm
height 84 cm
depth 45 cm



bedside table **GLST**
width 45 cm
height 55 cm
depth 45 cm



bed without storage **GLL**
width 150 | 170 | 190 cm
height 103-109 cm
depth 216 cm



bed with storage **GLP**
width 150 | 170 | 190 cm
height 103-109 cm
depth 216 cm



wardrobe **GLSZ-3D**
(small grids)
width 161 cm
height 207 cm
depth 63 cm

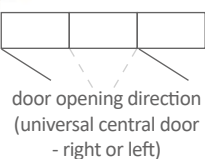

wardrobe **GLSZ-4D**
(large grids)
width 214 cm
height 207 cm
depth 63 cm

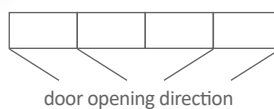

wardrobe **GLSZ-2DL**
left
(large grids)
width 109 cm
height 207 cm
depth 63 cm

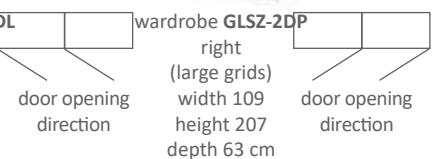



Bed headboard available only with fabric Zoya 5 Fargotex

Available colourings of MultiDecor: Natural Hickory + Portland Ash + Anthracite Chromix



top of the chest of drawers and bedside table is covered with high-quality, polished sinter quartz



bedside table **MDST**
width 47 cm
height 44 cm
depth 42 cm



bed **MDL**
without storage
width 156 | 176 | 196 cm
height 105
df. 227 cm



bed **MDLP**
with storage
width 156 | 176 | 196 cm
height 105
df. 227 cm



chest of drawers **MDKO-2D2S**
width 94 cm
height 85 cm
depth 42 cm



chest of drawers **MDKO-3D3S**
width 139 cm
height 85 cm
depth 42 cm



wardrobe **MDSZ-3D**
width 150 cm
height 206 cm
depth 60 cm



wardrobe **MDSZ-4D**
width 198 cm
height 206 cm
depth 60 cm



CREMONA bedroom



CREMONA colors: light sonoma oak + cappuccino



wardrobe with swing doors
CSZP-3D
width 270 cm
height 232 cm
depth 68 cm



wardrobe with swing doors
CSZP-2D
width 200 cm
height 212 cm
depth 68 cm



chest of drawers
CKO-2D4S
width 156 cm
height 85 cm
depth 42 cm



chest of drawers
CKO-1D4S
width 111 cm
height 85 cm
depth 42 cm



chest of drawers
CKO-6S
width 66 cm
height 121 cm
depth 42 cm



mirror **CLU-1**
width 130 cm
height 65 cm



wardrobe with sliding doors
CSZ-5D
width 230 cm
height 212 cm
depth 63 cm



wardrobe with sliding doors
CSZ-4D
width 185 cm
height 212 cm
depth 63 cm



wardrobe with sliding doors
CSZ-3D
width 140 cm
height 212 cm
depth 63 cm



wardrobe with sliding doors
CSZ-2D
width 95 cm
height 212 cm
depth 63 cm



wardrobe with sliding doors
CSZ-1D
width 50 cm
height 212 cm
depth 63 cm



corner wardrobe with swing door
CSZ-1DN
width 92/92 cm
height 212 cm



bed **CL** without storage
width 151 | 171 | 191 cm
height 95 cm
depth 213 cm



bed **CLP** with storage
width 151 | 171 | 191 cm
height 95 cm
depth 213 cm



bedside table
CST-2S
width 50 cm
height 43 cm
depth 41 cm

NEW YORK bedroom



NEW YORK colors: alpine white + uni truffle



chest of drawers **NYKO-2D55**
width 151 cm
height 94 cm
depth 46 cm



chest of drawers **NYKO-3S**
width 101 cm
height 96 cm
depth 46 cm



bedside table
NYST-1S
width 51 cm
height 44 cm
depth 42 cm



desk **NYBI**
width 101 cm
height 78 cm
depth 60 cm

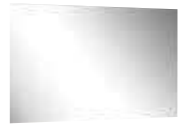

mirror **NYLU-1**
width 100 cm
height 50 cm



bed with lightning **NYL** without storage
bed with lightning **NYLP** with storage
width 97 | 147 | 167 | 187 cm
height 95 cm | depth 208 cm



bed **NYT** with upholstered headboard and without storage
bed **NYTP** with upholstered headboard and with storage
width 97 | 147 | 167 | 187 cm
height 95 cm | depth 208 cm



3 door wardrobe - swing doors
NYSZ-3D2S
width 164 cm
height 211 cm
depth 64 cm



2 door wardrobe with sliding doors
NYSZP 2D
width 182 cm
height 213 cm
depth 68 cm



3 door wardrobe with sliding doors
NYSZP 3D
width 271 cm
height 213 cm
depth 68 cm

SLEEP VARIA SYSTEM - SET WITH BED - RAVENA WALNUT



in the picture set SLEEP VARIA:
 Element 12 | Element 20 | Item 27
 Color variant A
 Bed MiniMaxi 160x200 with storage
 Headboard 2700 with a height of 120 cm.



Item list of SLEEP VARIA set with bed

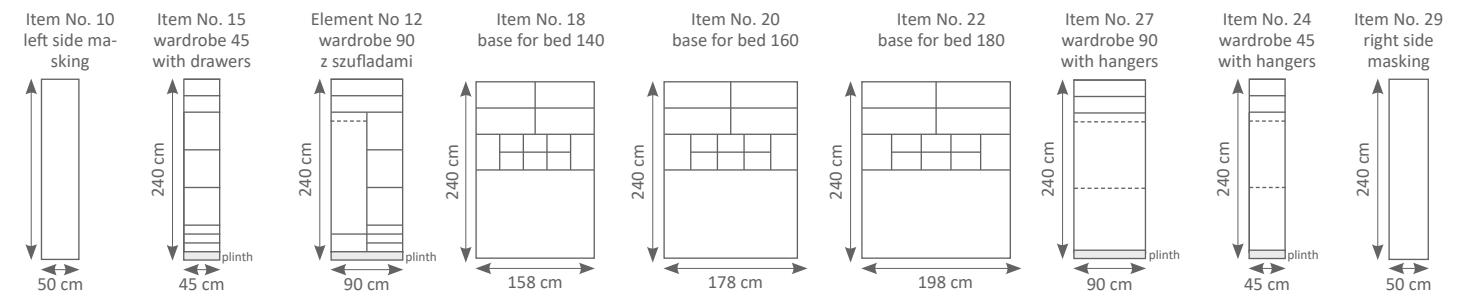

Available colourings of SLEEP VARIA set with bed



lateral dimensions

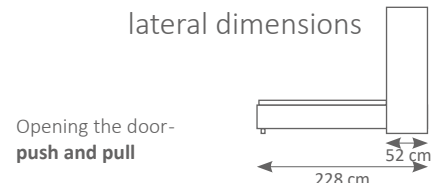

SYSTEM SLEEP VARIA - ZESTAW Z ŁÓŻKIEM - HIKORA OAK



in the picture set SLEEP VARIA:
 Element 10 | Item 27 | Element 20 | Element 12 | Item 29
 Color variant C.
 Bed MiniMaxi 160x200 with storage
 Headboard 3000, 120 cm high.



Wymiary łóżek

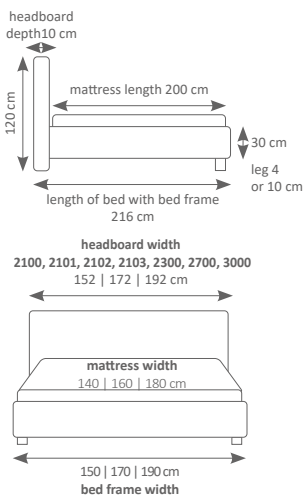

MINI MAXI bed
with headboard 2101



MINI MAXI bed
with headboard 2102



MINI MAXI bed
with headboard 2103



MINI MAXI bed
with headboard 2300



MINI MAXI bed
with headboard 2700



MINI MAXI bed
with headboard 3000



SLEEP VARIA SYSTEM - SET WITH BED AND BEDSIDE TABLES



In the picture set SLEEP VARIA:
Element 24 | Item 44 | Item 24
Color variant A
Bed MiniMaxi 160x200 with storage
Headboard 3000, 120 cm high.

Bed models for SLEEP VARIA with bedside tables: 2100, 2101, 2102, 2103, 2300, 2700, 3000

AVAILABLE BEDS DIMENSIONS

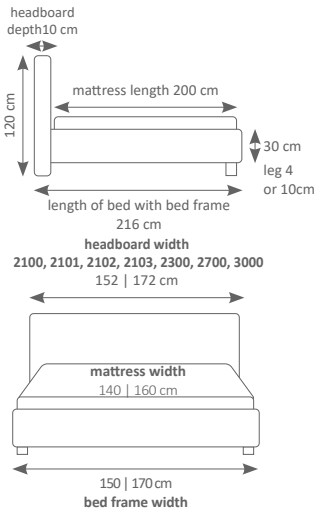

Item list of SLEEP VARIA set with bed and bedside tables

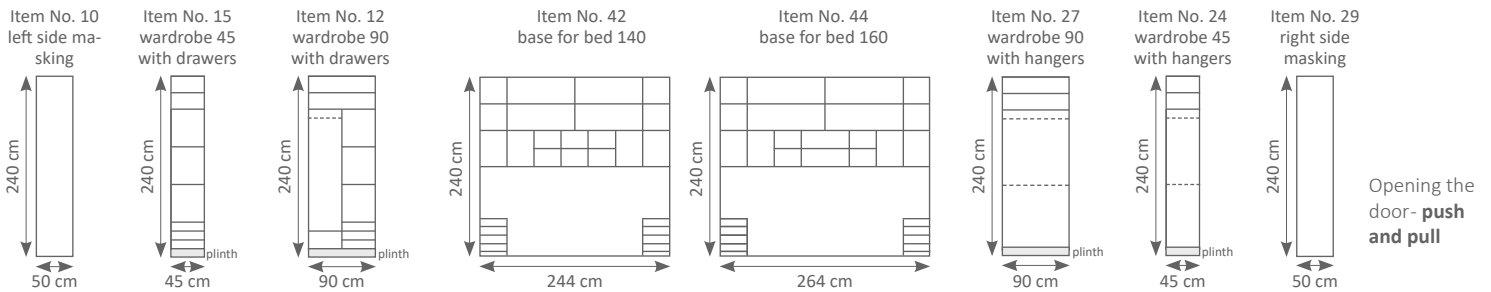

Available colourings of SLEEP VARIA set with bed and bedside tables



lateral dimensions

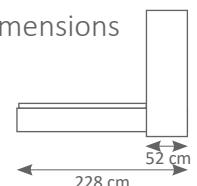

BEDSIDE TABLES

COMPLEMENTARY FURNISHINGS



Bolsena
width 52 | height 40
depth 42 cm



Standard
width 50 | height 37
depth 37 cm



Diament
width 53 | height 40
depth 39 cm



Roma
width 63 | height 43
depth 39 cm



Calgary
width 56 | height 34
depth 41 cm, push and pull

NEW



Havana
width 50 | height 44
depth 44 cm



Nord
width 50 | height 50
depth 37 cm
push and pull

NEW



Layla
width 53 | height 51
depth 40 cm



Royal A
width 49 | height 51 cm
push and pull



Royal A
open drawers



Royal C
width 49 | height 47 cm
push and pull



Continental B
width 53 | height 46
depth 41 cm



Continental C
width 51 | height 51
depth 40 cm



Continental D
width 51 | height 51
depth 40 cm



Continental D
otwarte szuflady



Continental E
width 51 | height 61
depth 40 cm



Rondo
width 47 | height 46



Cezar
width 55 | height 37 | depth 40 cm
color: white, black, grey
push and pull



Natural
width 40 | height 54
depth 45 cm
push and pull

white



GLASS table finished with glass:
width 51 | height 44 | depth 42 cm
push and pull

grey



black



SoftLoft
width 53 | height 46
depth 37 cm
push and pull

BENCHES



bench E
width 120 | height 45 | depth 46 cm
available colors of bench frame
E: black | grey



bench F
width 120, 140 | height 65 | depth 46 cm
Colourings of wooden legs of the F, G benches on page 51



bench G
width 120, 140 | height 65 | depth 46 cm



bench H
width 122 | height 43 | depth 46 cm
available colors of bench frame H:
grey | gold

POUFFES



pouf ROMA
width 48 | height 46 | depth 48 cm



pouf ROYAL A with storage
width 120 | 140 | 160 cm
height 34 cm + leg | depth 50 cm



pouf ROYAL B with storage
width 120 | 140 | 160 cm
height 34 cm + leg | depth 50 cm

ROYAL legs available: 27, 28, 29, 33, 34, 35. (page 51)

CHESTS OF DRAWERS



chest of drawers SoftLoft
width 110 | height 80 | depth 55 cm
push and pull



chest of drawers GLASS with glass finishing
width 100 | height 82 | depth 42 cm
color: white, black, popiel
push and pull

MATTRESSES

mattress **ELITE 27**
medium firm, one-sided
mattress

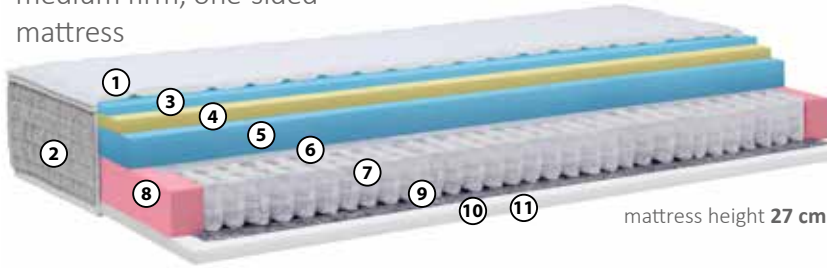

- ① The upper part of the cover with the possibility of choosing a fabric, 1a) inner protective cover for the mattress insert
- ② Highly permeable fabric for excellent ventilation the inside of the mattress, which prevents the accumulation of moisture and the development of dust mites and mold
- ③ High resilience foam with thickness of 2 cm
- ④ Thermoelastic foam with a thickness of 3 cm (density 50 kg/1m³)
- ⑤ High resilience foam with thickness of 7 cm
- ⑥ Interfacing
- ⑦ Pocket springs medium hard of 12 cm height(255 springs per 1m² of mattress surface)
- ⑧ High density T-30 foam, 8 cm wide, preventing deformation of the mattress edges
- ⑨ Felt filling with a weight of 500 g
- ⑩ Hard foam with thickness of 3 cm
- ⑪ Quilted mattress fabric

Mattress **ELITE 21**
Medium firm, one-sided
mattress

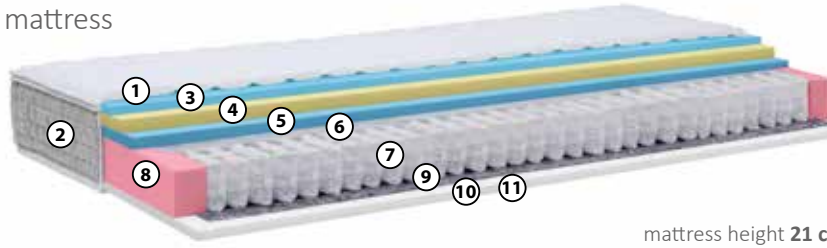

- ① The upper part of the cover with the possibility of choosing a fabric, 1a) inner protective cover for the mattress insert
- ② Highly permeable fabric for excellent ventilation the inside of the mattress, which prevents the accumulation of moisture and the development of dust mites and mold
- ③ High resilience foam with thickness of 2 cm
- ④ Thermoelastic foam with a thickness of 3 cm (density 50 kg/1m³)
- ⑤ High resilience foam with thickness of 2 cm
- ⑥ Interfacing
- ⑦ Pocket springs medium hard of 12 cm height(255 springs per 1m² of mattress surface)
- ⑧ High density T-30 foam, 8 cm wide, preventing deformation of the mattress edges
- ⑨ Felt filling with a weight of 500 g
- ⑩ Hard foam with thickness of 2 cm
- ⑪ Quilted mattress fabric

Mattress **ROSA**
Medium firm, one-sided mattress

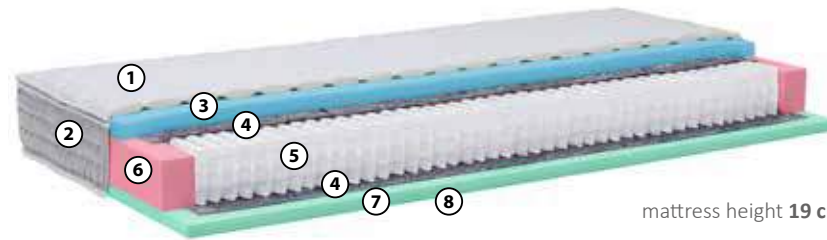

- ① The upper part of the cover with the possibility of choosing a fabric 1a) inner protective cover for the mattress insert
- ② Highly permeable fabric for excellent ventilation the inside of the mattress, which prevents the accumulation of moisture and the development of dust mites and mold
- ③ Thermoelastic foam with a thickness of 4 cm (density 50 kg/1m³)
- ④ Felt filling with a weight of 500 g
- ⑤ Pocket springs medium hard of 12 cm height(576 springs per 1m² of mattress surface)
- ⑥ High density T-30 foam, 8 cm wide, preventing deformation of the mattress edges
- ⑦ T-25 foam with a thickness of 3 cm
- ⑧ Quilted mattress fabric

mattress **FINEZJA**
medium soft, one-sided
mattress

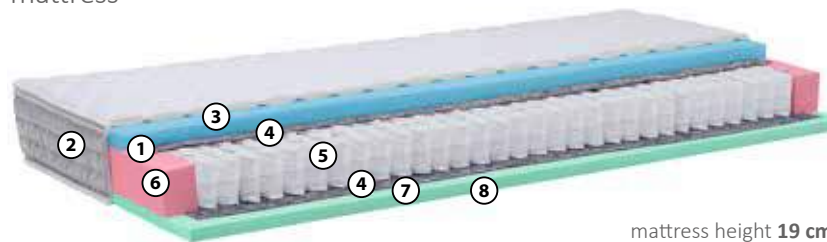

- ① The upper part of the cover with the possibility of choosing a fabric 1a) inner protective cover for the mattress insert
- ② Highly permeable fabric for excellent ventilation the inside of the mattress, which prevents the accumulation of moisture and the development of dust mites and mold
- ③ Thermoelastic foam with a thickness of 4 cm (density 50 kg/1m³)
- ④ Felt filling with a weight of 500 g
- ⑤ Pocket springs medium hard of 12 cm height (255 springs per 1m² of mattress surface)
- ⑥ High density T-30 foam, 8 cm wide, preventing deformation of the mattress edges
- ⑦ T-25 foam with a thickness of 3 cm
- ⑧ Quilted mattress fabric

mattress **BOSS**
firm, double-sided
mattress

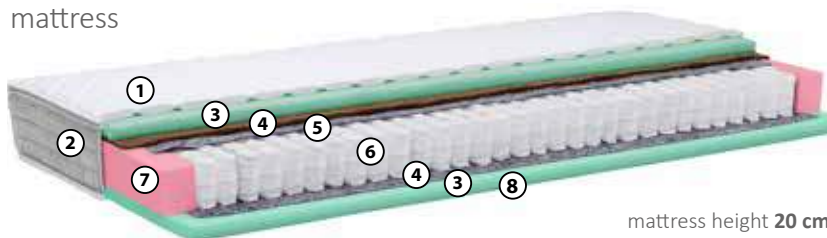

- ① The upper part of the cover with the possibility of choosing a fabric 1a) inner protective cover for the mattress insert
- ② Highly permeable fabric for excellent ventilation the inside of the mattress, which prevents the accumulation of moisture and the development of dust mites and mold
- ③ T-25 foam with a thickness of 3 cm
- ④ Coconut mat with a thickness of 1.5 cm
- ⑤ Felt filling with a weight of 500 g
- ⑥ Pocket springs medium hard of 12 cm height (255 springs per 1m² of mattress surface)
- ⑦ High density T-30 foam, 8 cm wide, preventing deformation of the mattress edges
- ⑧ Quilted mattress fabric

MATTRESSES

mattress RUBIN
firm, double-sided
mattress

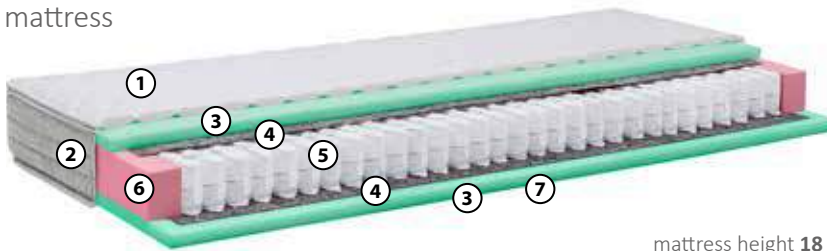

mattress height 18

- ① the upper part of the cover with the possibility of choosing a fabric 1a) inner protective cover for the mattress insert
- ② Highly permeable fabric for excellent ventilation the inside of the mattress, which prevents the accumulation of moisture and the development of dust mites and mold
- ③ T-25 foam with a thickness of 3 cm
- ④ Felt filling with a weight of 500 g
- ⑤ Pocket springs medium hard of 12 cm height (255 springs per 1m² of mattress surface)
- ⑥ High density T-30 foam, 8 cm wide, preventing deformation of the mattress edges
- ⑦ T-25 foam with a thickness of 3 cm

mattress DALIA SMART
firm mattress

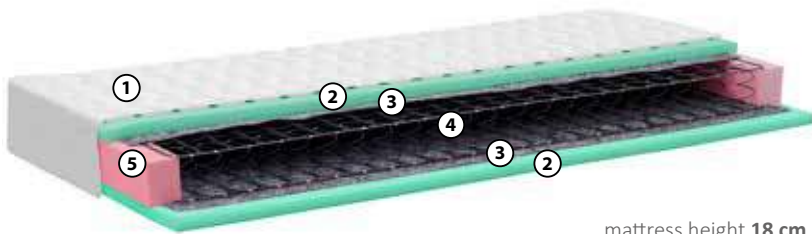

mattress height 18 cm

- ① Cover made of Jersey type fabric, in white, quilted on the 150g unwoven cloth, without the choice of fabric.
- ② T-25 foam with a thickness of 3 cm
- ③ Felt filling with a weight of 500 g
- ④ Bonnel springs with frames
- ⑤ High density T-30 foam, 8 cm wide, preventing deformation of the mattress edges

MATTRESSES IN LUX VERSION FOR CONTINENTAL BEDS

Each mattress from the N. E. 2020/2021 offer can be ordered in the LUX version. This version means that the edge of the mattress is finished with the same fabric as the bed frame and the headboard. This solution is especially recommended for continental beds. By using a mattress in the LUX version we obtain a homogeneous edge of the bed and the mattress.

Mattress cover in LUX version



Mattress fabric to choose from (fabric patterns can be found on next page)

Side of the mattress made of upholstery fabric (as at the headboard and bed base)

SAMPLE MATTRESSES IN LUX VERSION

Mattress ELITTE 27

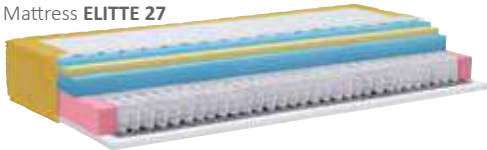

Mattress BOSS



Mattress DALIA SMART

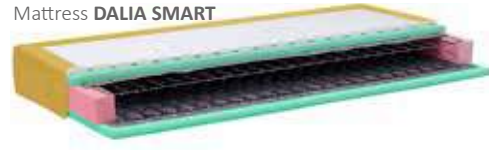

Mattress ELITTE 21



Mattress FINEZIA



Mattress ROSA



Mattress RUBIN



CHOOSE A FABRIC COVER FOR YOUR MATTRESS



FLOWER 3D

3D flowers is an extremely strong fabric with a three-dimensional structure. The unique Italian design with a floral motif gives the cover a prestigious look. It is made of polyester yarn that provides very high durability. Even numerous washing at a maximum temperature of no more than 40 ° C does not adversely affect the fabric's loss of its technical parameters. It is characterized by very good air permeability, which makes the mattress internal fresh and clean. The fabric works very well on a cover for thermoelastic mattresses. It fits perfectly with the mattress insert, which adapts to the body. It has a high basis weight of 500 g/m²



AMICOR Zn 3D

The most important feature of the Amicor fabric is the content in its structure of unique acrylic fibers. As a result, the fabric is durable and does not lose its properties even when washing at temperatures up to 40 ° C. Amicor fibers fulfill two functions: antibacterial and antifungal. The antibacterial function is related to the Irgasan content that prevents from bacterial growth and eliminates the unpleasant smell of sweat. For this reason, such fabric for a cover is especially recommended for people with increased sweating. It allows you to get a feeling of freshness and comfort of sleep also in a warm climate. In turn, the antifungal function consists in the neutralization of microorganisms appearing on the surface of the mattress, which, penetrating into its interior, could become food for mites. In combination with the very high ventilation provided by the cover Amicor mattress becomes cleaner and our sleep healthier. The Amicor fabric is strong, very durable, with a dense structure (weight 500gr / m²). The fabric retains its antibacterial and anti fungal properties regardless of the number of washing cycles. The maximum washing temperature should not exceed 40 ° C.



SILVER AG+ 3D

SILVER AG + 3D is a fabric with a very high density of 500gr / m². Its unquestionable advantage is the content of silver ions, which act antibacterial and antistatic. Silver ions also inhibit the proliferation of mites and mold growth, as well as prevent the formation of unsightly odors. Silver removes electrostatic charges accumulating on our skin through contact with synthetics. Thanks to that we relax faster and we are able to rest more effectively. Silver AG + fabric has lyocell fibers on its surface, which makes it very durable, while retaining exceptional delicateness in contact with the skin. The presence of lyocell fibers also positively influences the absorption of moisture through the cover and prevents its penetration into the interior, which translates into the cleanliness of the mattress. Taking into consideration all the properties of SILVER AG + fabric, it is especially recommended for people sensitive to all skin irritations and allergies. The fabric retains its antibacterial and antistatic properties even after 5 washes. The maximum washing temperature should not exceed 40 ° C.



THERMO 37°

The fibres of this fabric contain paraffin PCM capsules capable of keeping a constant body temperature at 37 ° C. Appropriate constant temperature means healthy and good sleep comfort. We especially recommend it for mattress covers made of thermoelastic foam which, due to its perfect adaptation to the body, automatically increases its temperature. The THERMO 37 ° fabric ensures a lower temperature and retaining it at 37 ° C. PCM Cell Solution Clima capsules are in a mixture with Lyocell fibers, which in turn are responsible for the elimination of moisture, bacteria and sweat. The maximum washing temperature should not exceed 40 ° C.



Milky - Pleasure in 3D

Mattress cover is made of double fabric with 3D effect. The rich content of amino acids in the cover ensures proper hydration of the skin. It also has antibacterial properties, provides comfortable sleep on an extremely soft surface and allows free air flow between the body and the surface of the mattress. The maximum washing temperature should not exceed 40 ° C.

THERMOELASTIC FOAM VENTILATED PILLOWS

Anatomic pillows are made of thermoelastic foam, the properties of which enable a perfect fit to the line defined by the arms, neck and head. That provides the proper way to support the spine during sleep and rest. The foam adapts to the shape of the body under the impact of temperature. The air channels used in the pillow ensure its proper internal ventilation. The profiled pillow brings relief in the case of many ailments, such as neck-ache, backache, headaches and snoring. It is also possible to choose a cover.

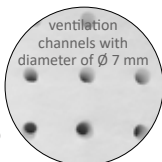

Shaped 50x40x11



Classic 60x40x10



Contoured 60x40x12



Profile 60x43x11

MATTRESS TOPPERS



Foam topper (4 cm.)



Latex topper (4 cm.)



Thermoelastic topper (5 or 7 cm)



BED SLATS FOR BEDS WITHOUT STORAGE

STANDARD

- 28 elastic slats with a width of 35 mm
- 5 slats with hardness adjustment
- bed slats height approx. 5 cm
- spacing between slats 25 mm



ECONOMIC DUO

- self-assembly
- 28 elastic slats with a width of 35 mm
- bed slats height approx. 3 cm
- spacing between slats 32 mm



BED SLATS FOR STORAGE BEDS

STANDARD FRAME L53

- 24 flexible slats with a width of 53 mm
- spacing between lamellas 25 mm
- a metal frame with a cross-section of 40 x 30 mm
- bed slats height about 55 mm



STANDARD FRAME L53

- it is a metal bed slats for a bed with a container ensuring satisfactory quality while having a very affordable price. Its construction was based on a system of flexible slats made of layered glued non-coniferous hardwood fixed on a metal frame. The central beam of this frame has an additional reinforcement on both sides. Small spacing between the slats allows the use of a bed slats for any type of mattress also for hotels and guest houses.

COMFORT L38 FRAME

- 30 flexible slats with a width of 38 mm
- spacing between lamellas 25 mm
- a metal frame with a cross-section of 40 x 40 mm
- bed slats height about 70 mm
- 6 lamellas with hardness adjustment
- Flexible duoflex holders provide double cushioning and no so-called dead zone in the middle part of the bed slats.

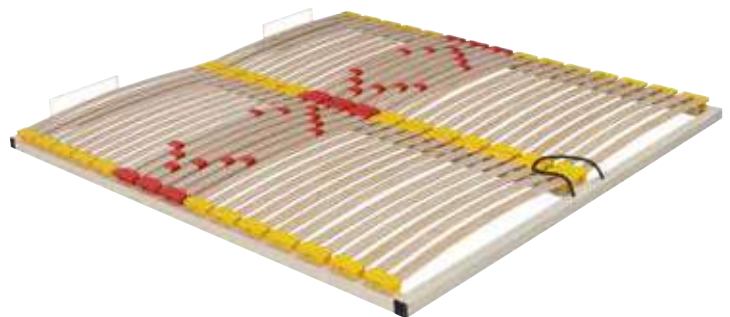

COMFORT L38 FRAME

- it is a metal bed slats for a bed with a container with a double center beam providing a very stable, and at the same time extremely flexible support for the mattress. The system of narrow transversely springy slats of layered glued non-coniferous hardwood placed in elastic duoflex pockets allows it to be used for all types of mattresses. Complementing the high comfort of this bed slats is the ability to adjust its hardness. In this way, each user can adjust the desired support hardness for his mattress depending on his expectations and weight.



In the picture corner sofa MADRID FH
Fabric FIBERO DIEGO 6008



Corner sofa
with storage and sleeping function
height 88 | width 225x180 | depth 107 cm
sleeping area 155 x 203 cm



movable backrests



LOUISIANA



In the picture: a set of an armchair, sofa 2, sofa 3 LOUISIANA
Fabric VELIERO 22/ ROJA 07, BY ZIEN FARGOTEX COLLECTION



armchair
height 84 | width 98 |
depth 88 cm



sofa S2
height 84 | width 152 |
depth 88 cm



unfolded sofa bed S2
height 84 | width 176 | depth 88 cm
sleeping area 117x190



sofa S3
height 84 | width 207 |
depth 88 cm



unfolded sofa bed S3
height 84 | width 207 | depth 88 cm
sleeping area 137x190



In the picture: set of an armchair and sofa 2 PARIS
fabric AVA 21 / AVA 9, BIBTEX



sofa S3
height 88 | width 235 | depth 96 cm



sofa S2
height 88 | width 208 | depth 96 cm



ottoman (prawa)
height 88 | width 188 | depth 96 cm



sofa S2,5R (sleep funktion)
height 88 | width 221 | depth 96 cm
sleep funktion 202x134



armchair LUX
height 107 | width 94 | depth 85 cm



armchair CLASSIC
height 107 | width 94 | depth 85 cm



pouf
height 47 | width 52 | depth 52 cm



coffee table
height 44 | width 110 | depth 67 cm

PRADO



In the picture: set of PRADO 2.5, armchairs and sofa
fabric GENOVA 804, SYMPHONY



armchair
height 72 | width 96 | depth 98 cm



sofa S2
height 72 | width 177 | depth 98 cm



sofa S2,5
height 72 | width 215 | depth 98 cm



sofa S3
height 72 | width 252 | depth 98 cm



In the picture a corner sofa set BERGEN FH fabric ROJA 07, FARGOTEX



armchair

height 85 | width 80 | depth 85 cm



sofa S2

height 85 | width 150 | depth 85 cm



sofa S3

height 85 | width 222 | depth 85 cm



corner sofa FH

height 85 | width 222x165 | depth 85 cm

In the picture sofa B+A+A+A+B; height 80 | width 288 | depth 100 cm
Fabric BRU BRAVEHEART 11 CHARCOAL



B

height 56 | width 24 | depth 100 cm



A

height 80 | width 80 | depth 100 cm



H

height 80 | width 80 | depth 157 cm



corner sofa B+H+A+A+B

height 80 | width 288x157 | depth 100 cm



In the picture a corner sofa MALMO
Fabric CAMERON 500, DEKOMA



In the picture sofa S3 and armchair MALMO
Fabric VENUS VELVET 2940, TOP TEXTIL



armchair



sofa S2



sofa S3



corner sofa

height 83 | width 80 | depth 80 cm

height 83 | width 174 | depth 80 cm

height 83 | width 217 | depth 80 cm

height 83 | width 255x165 | depth 80 cm

UPHOLSTERED FURNITURE



In the picture set LIZBONA - 2 x armchair, sofa S2 and pouf
Fabric GENOVA 601, SYMPHONY

LIZBONA



sofa S2,5
height 103 | width 181 |
depth 97 cm



sofa S2
height 103 | width 140 |
depth 97 cm



armchair
height 103 | width 79 |
depth 97 cm



pouf
height 42 | width 50 |
depth 50 cm



In the picture set NICEA - 2 x armchair, sofa S2,5 and coffee table
Fabric GENOVA 701, SYMPHONY

NICEA



sofa S2,5
height 103 | width 185 |
depth 90 cm



sofa S2
height 103 | width 144 |
depth 90 cm



armchair
height 103 | width 84 |
depth 90 cm



pouf
height 42 | width 50 |
depth 50 cm



In the picture set 2 x armchair,
sofa S2 and coffee table PATTI
Fabric SAMUI 142 ARTEX

PATTI



sofa S2
height 102 | width 158 |
depth 85 cm



podnózek
height 44 | width 51 |
depth 49 cm



coffee table
height 55 | width 101 |
depth 60 cm



armchair
height 102 | width 77 |
depth 85 cm



In the picture armchair, sofa S2 and pouf BARI
Fabric CHARLES 38, DEKOMA

BARI



sofa S2
height 79 | width 140 |
depth 62 cm



armchair
height 79 | width 73 |
depth 62 cm



pouf
height 44 | width 40 |
depth 40 cm



ARMCHAIR TOMMY ON A METAL FRAME

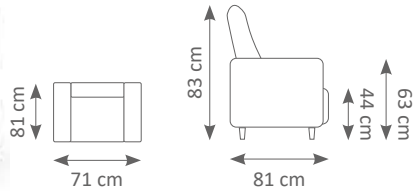

ARMCHAIR LONDON

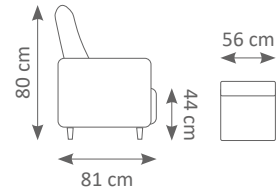

ARMCHAIR TOMMY ON WOODEN LEGS

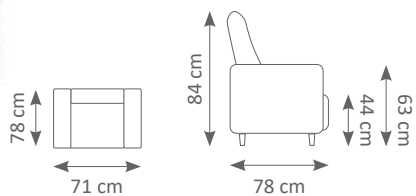

ARMCHAIR MONRO

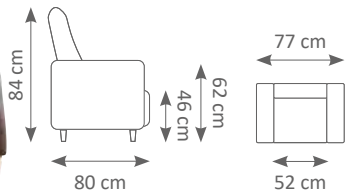

ARMCHAIR TOMMY PLUS ON A METAL FRAME WITH A BACK SUPPORTING CUSHION

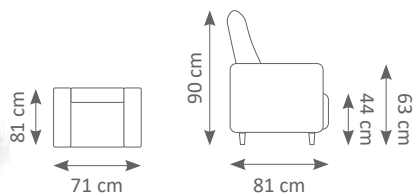

CHAIR AMSTERDAM

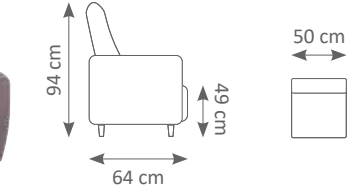

ARMCHAIR TOMMY PLUS ON WOODEN LEGS WITH A BACK SUPPORTING CUSHION

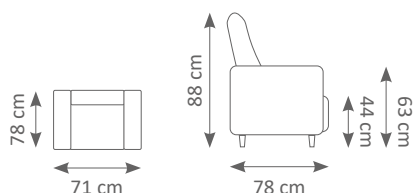

bar table NICEA with glass top
height 52 | width 60 | depth 60 cm



coffee table NICEA with glass top
height 52 | width 110 | depth 60 cm

AVAILABLE COLOURINGS OF WOODEN LEGS



beech lacquer 01



oak oiled 11

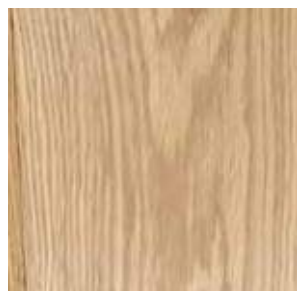

oak lacquer 28

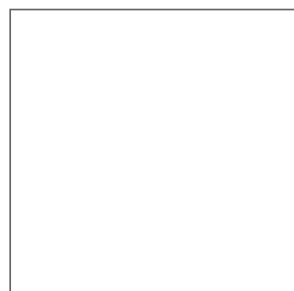

white 26



alder 21



alder 22



alder 23



black 24



silver 23



gold 27

NEW



LOFT KARMEL bedroom

NEW ELEGANCE
FURNITURE

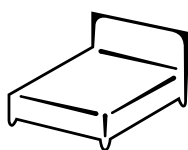

STOLWIT MEBLE Sp. z o.o. Sp.k.

98-400 WIERUSZÓW, POLESIE 25, POLAND

Head office: tel. +48 627842632, tel. +48 627842498

SALES DEPARTMENT:

Poland – tel. +48 627842044 e-mail: info@newelegance.pl

Export – tel. +48 627831517 e-mail: export@newelegance.pl

fax.: +48 627841100

www.newelegance.pl

This catalogue does not constitute a legal offer and is published for informational purposes only! The manufacturer reserves the right to make structural changes in the furniture offered without changing their overall nature. All dimensions are given in cm with a tolerance of +/- 3%. Due to the printing process, the colors of the furniture in the pictures may differ from the actual. Edition december 2021