



**GALA**  
COLLEZIONE

The offer shall not be any offer in accordance with the regulations of the Civil Code. The colors of upholstery can differ from the presented versions on the photographs. The producer reserves the right to make structural amendments in offered upholstery without changing its general character.

Информация, содержащаяся в каталоге, не является юридически обязательной и не является предложением в понимании Гражданского кодекса. Продукты и их цвета, представленные в каталоге, могут отличаться от реальных продуктов и цветов. Производитель оставляет за собой право вносить конструктивные изменения в предлагаемые модели, не изменяя их общего характера.

Les informations présentées dans le catalogue ne revêtent pas de caractère juridiquement contraignant et ne constituent pas une offre commerciale au sens du Code Civil. Les produits et leurs couleurs présentés dans le catalogue peuvent différer de produits et de couleurs réelles. Le fabricant se réserve le droit d'apporter de modifications structurelles aux modèles offerts sans changer leur caractéristique générale.

**GALA**  
COLLEZIONE

*Empirex...*

# Table of Contents

A	<b>ALBANO</b>	8	CONTEMPORARY	D	<b>DANA II</b>	14	CONTEMPORARY
	<b>ANCONA</b>	92	NIGHT & DAY		<b>DIM</b>	128	ARMCHAIRS - CLASSIC
	<b>ANETO</b>	94	NIGHT & DAY		<b>DOMO</b>	36 - 37	MODULAR SYSTEMS
	<b>ARLES/EDEN</b>	93	NIGHT & DAY		<b>DOT</b>	126	ARMCHAIRS - MODERN
	<b>ARNO/ANETO</b>	94	NIGHT & DAY		<b>DOT II</b>	126	ARMCHAIRS - MODERN
	<b>AROSA</b>	120	ARMCHAIRS - SMART	E	<b>EDEN</b>	93	NIGHT & DAY
	<b>AXEL</b>	9	CONTEMPORARY		<b>ELIO/MALMO</b>	97	NIGHT & DAY
B	<b>BARISTA</b>	116			<b>EMA</b>	90	NIGHT & DAY
	<b>BELLUNO</b>	26 - 27	MODULAR SYSTEMS	F	<b>FAVA</b>	15	CONTEMPORARY
	<b>BERN</b>	120	ARMCHAIRS - SMART		<b>FIDO</b>	127	ARMCHAIRS - MODERN
	<b>BIBBI</b>	130	ARMCHAIRS - ENJOY		<b>FIORD</b>	98	NIGHT & DAY
	<b>BLOM</b>	95	NIGHT & DAY		<b>FORLI</b>	71	RELAX & COMFORT
	<b>BODO</b>	105	NIGHT & DAY		<b>FRIDA</b>	121	ARMCHAIRS - SMART
	<b>BONO</b>	96	NIGHT & DAY	G	<b>GENOVA II</b>	16	CONTEMPORARY
	<b>BOSS</b>	128	ARMCHAIRS - CLASSIC		<b>GIRRO</b>	38 - 39	MODULAR SYSTEMS
	<b>BUSTO</b>	80	RELAX & COMFORT	H	<b>HAPPY</b>	99	NIGHT & DAY
C	<b>CALPE</b>	28 - 29	MODULAR SYSTEMS	I	<b>INARI</b>	123	ARMCHAIRS - SMART
	<b>CAMELIA</b>	10	CONTEMPORARY	K	<b>KARATO</b>	40 - 41	MODULAR SYSTEMS
	<b>CANTATA</b>	30 - 31	MODULAR SYSTEMS		<b>KELSO</b>	76	RELAX & COMFORT
	<b>CAPELLA</b>	11	CONTEMPORARY		<b>KOMO</b>	123	ARMCHAIRS - SMART
	<b>CAPRI</b>	32 - 33	MODULAR SYSTEMS	L	<b>LIDO</b>	100	NIGHT & DAY
	<b>CATANIA</b>	12	CONTEMPORARY		<b>LORIEN</b>	73	RELAX & COMFORT
	<b>CHAIRS</b>	132			<b>LOTOS</b>	101	NIGHT & DAY
	<b>CHOCO</b>	81	RELAX & COMFORT		<b>LUCIANO</b>	42 - 43	MODULAR SYSTEMS
	<b>COLETTA</b>	13	CONTEMPORARY	M	<b>MALMO</b>	97	NIGHT & DAY
	<b>CORTADO</b>	117			<b>MALPENSA</b>	102	NIGHT & DAY

	<b>MANTUA II</b>	17	CONTEMPORARY		<b>SCANDI</b>	72	RELAX & COMFORT
	<b>MASSIMO</b>	44 - 45	MODULAR SYSTEMS		<b>SERENA</b>	62 - 63	MODULAR SYSTEMS
	<b>MEMO</b>	103	NIGHT & DAY		<b>SISTO</b>	110	NIGHT & DAY
	<b>MERANO II</b>	18	CONTEMPORARY		<b>SNAP</b>	111	NIGHT & DAY
	<b>MERIDA</b>	48 - 49	MODULAR SYSTEMS		<b>SORA</b>	91	NIGHT & DAY
	<b>MEZZANA</b>	50 - 51	MODULAR SYSTEMS		<b>SORIZO</b>	129	ARMCHAIRS - CLASSIC
	<b>MODO</b>	104	NIGHT & DAY	T	<b>TIVOLI</b>	82	RELAX & COMFORT
	<b>MONDAY</b>	83	RELAX & COMFORT		<b>TOLEDO</b>	64 - 65	MODULAR SYSTEMS
N	<b>NAPPA/BODO</b>	105	NIGHT & DAY		<b>TOM</b>	122	ARMCHAIRS - SMART
	<b>NEO</b>	124	ARMCHAIRS - MODERN		<b>TULA</b>	112	NIGHT & DAY
	<b>NEO II</b>	124	ARMCHAIRS - MODERN	V	<b>VAPIANO</b>	113	NIGHT & DAY
	<b>NICEA</b>	19	CONTEMPORARY		<b>VENETO</b>	23	CONTEMPORARY
	<b>NOLA</b>	88	NIGHT & DAY		<b>VIGO</b>	114	NIGHT & DAY
	<b>NOVA</b>	106	NIGHT & DAY		<b>VOLTA</b>	68 - 69	MODULAR SYSTEMS
O	<b>OLAF</b>	107	NIGHT & DAY		<b>VOSS</b>	77	RELAX & COMFORT
	<b>OLBIA</b>	89	NIGHT & DAY	Y	<b>YUKA</b>	115	NIGHT & DAY
	<b>ORIO</b>	130	ARMCHAIRS - ENJOY	Z	<b>ZING</b>	125	ARMCHAIRS - MODERN
	<b>ORLY</b>	108	NIGHT & DAY		<b>ZING II</b>	125	ARMCHAIRS - MODERN
	<b>OVIEDO</b>	54 - 55	MODULAR SYSTEMS		General information	134	
P	<b>PABLO</b>	22	CONTEMPORARY		Общая информация	140	
	<b>PIKO</b>	122	ARMCHAIRS - SMART		Informations générales	146	
	<b>PLAZA</b>	58 - 59	MODULAR SYSTEMS				
	<b>POUFFES</b>	129	ARMCHAIRS - CLASSIC				
	<b>PRESTO</b>	127	ARMCHAIRS - MODERN				
R	<b>RES</b>	121	ARMCHAIRS - SMART				
S	<b>SALERNO</b>	109	NIGHT & DAY				





**GALA**  
COLLEZIONE

*Empirex...*

# ALBANO

The height of the furniture: **81 cm** (with the headrest folded)  
**95 cm** (with the headrest unfolded)  
 The height of the seat: **47 cm**  
 The depth of the seat: **57 cm**  
 The height of the legs: **25 cm**  
 The width of the side: **28 cm**



Chair XIV, fabric Rover 07 Shark, legs natural oak and 3L-OTM(4)SR, fabric Crown Velvet 20



Movable headrests



Platform legs

## dimensions

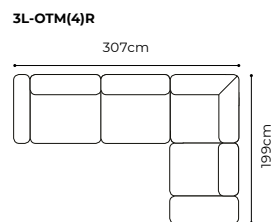
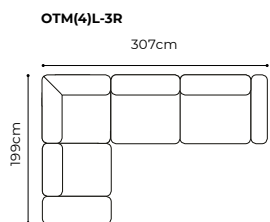



# AXEL

The height of the furniture: **101 cm**  
 The height of the seat: **49 cm**  
 The depth of the seat: **62 - 79 cm**  
 The height of the legs: **20 cm**  
 The width of the side: **18 - 21 cm**



TB and 2(150)L-1D90(1)R, fabric Caspar 16



Movable backrest



Movable armrest



Selection of leg type (black metal or black metal combined with wood)

## dimensions

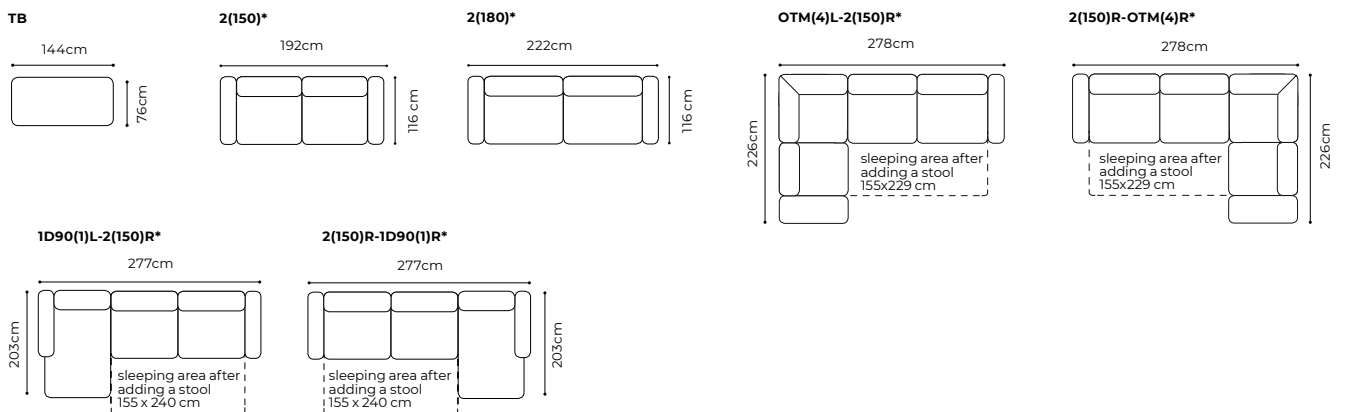

\*width and depth at maximally reclined armrests and backrest moved backwards

# CAMELIA

The height of the furniture: **71 cm** (with the headrest folded)  
**94 cm** (with the headrest unfolded)  
 The height of the seat: **46 cm**  
 The depth of the seat: **57 cm**  
 The height of the legs: **12 cm**  
 The width of the side: **23 cm**



2.5QLF-OTM(4)SR, leather G-2755



Sleeping function DELFIN



Bedding container



Movable headrests

## dimensions

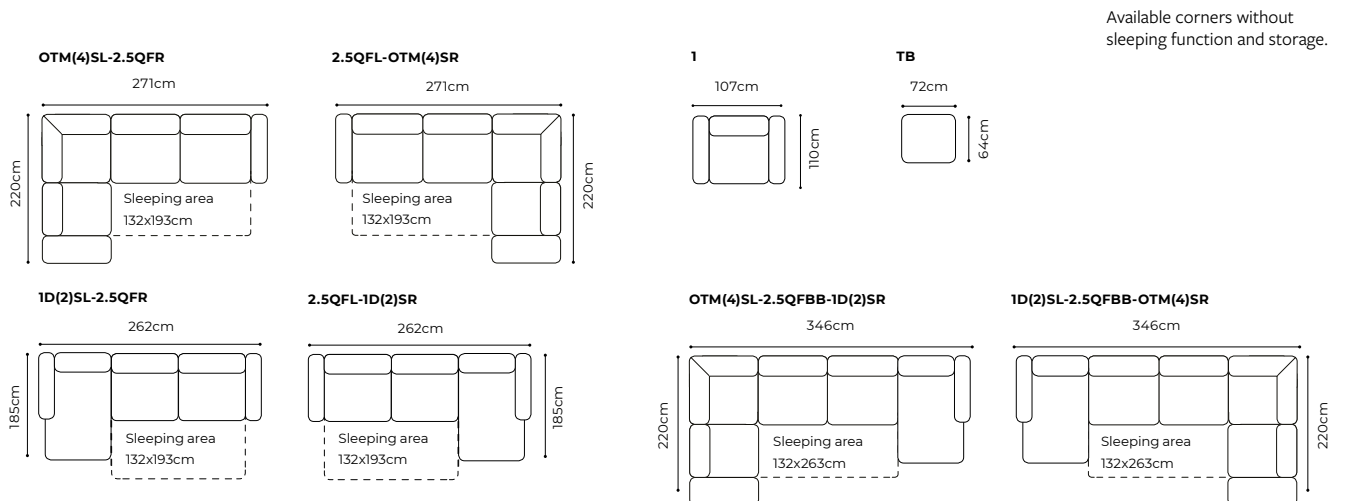

# CAPELLA



The height of the furniture: **73 cm** (with the headrest folded)  
**88 cm** (with the headrest unfolded)  
 The height of the seat: **43 cm**  
 The depth of the seat: **59 cm**  
 The height of the legs: **12 cm**  
 The width of the side (1): **19 cm**  
 The width of the side (other elements): **20 cm**



2 and 2.5L-EN(2)-2.5R, leather G-000



3



2



1

## dimensions

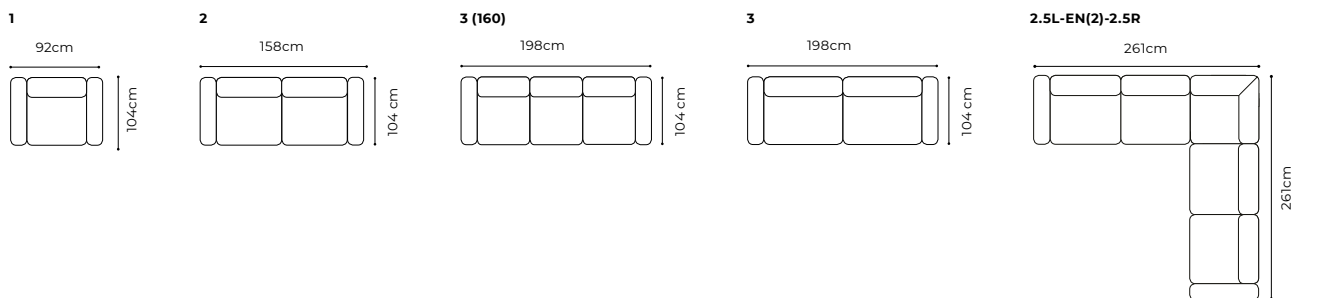

# CATANIA

The height of the furniture: **73 cm** (with the headrest folded)  
**93 cm** (with the headrest unfolded)  
 The height of the seat: **45 cm**  
 The depth of the seat: **58 cm**  
 The height of the legs: **12 cm**  
 The width of the side: **32 cm**



2.5FL-OTM(10)SR, leather: color withdrawn from the offer



Sleeping function DELFIN



Bedding container



Movable headrests

## dimensions

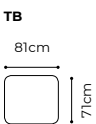
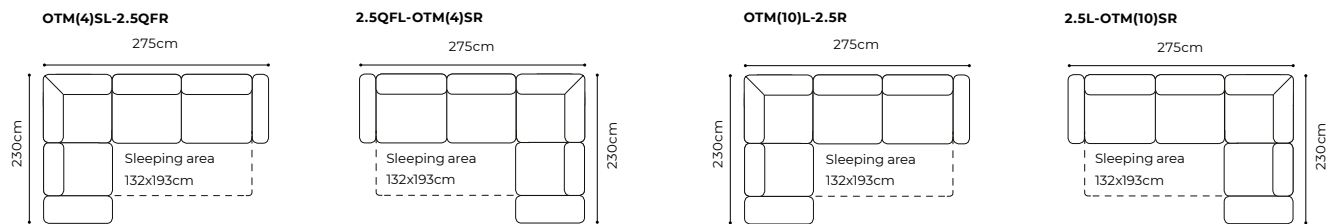

# COLETTO

The height of the furniture: **72 cm** (with the headrest folded)  
**94 cm** (with the headrest unfolded)  
 The height of the seat: **46 cm**  
 The depth of the seat: **57 cm**  
 The height of the legs: **12 cm**  
 The width of the side: **36 cm**



2.5QFL-QTM(4)SR, leather G-2170



Sleeping function DELFIN



Bedding container



Movable headrests

## dimensions

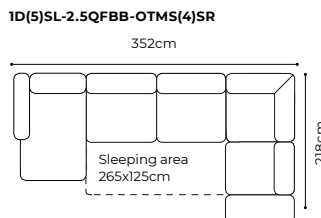
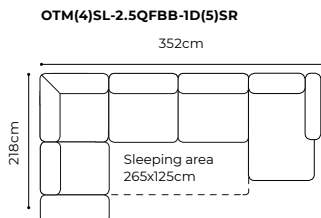
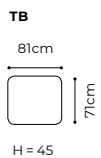
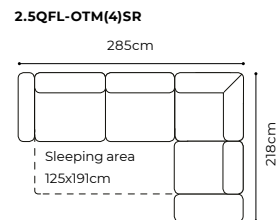
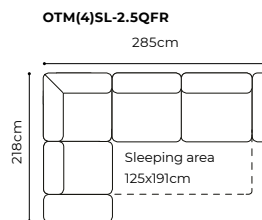
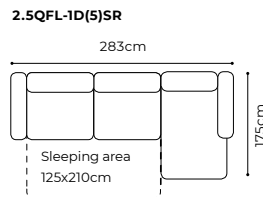
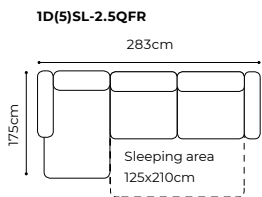

Available corners without sleeping function and storage

# DANA II

The height of the furniture: **78 cm** (with the headrest folded)  
**100 cm** (with the headrest unfolded)  
 The height of the seat: **43 cm**  
 The depth of the seat: **57 cm**  
 The height of the legs: **24 cm**  
 The width of the side: **42 cm**



3L-OTM(4)R, leather G-4150 Massive Ecrú

Available black legs



Movable headrests



Movable armrest

## dimensions

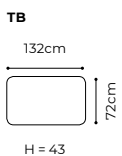
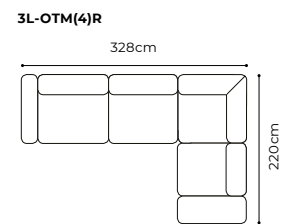
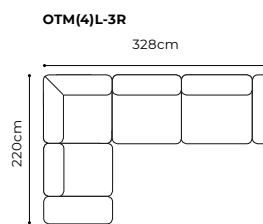
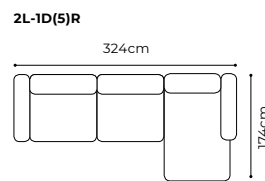
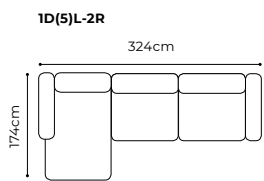

# FAVA

The height of the furniture: **75 cm** (with the headrest folded)  
**94 cm** (with the headrest unfolded)  
 The height of the seat: **45 cm**  
 The depth of the seat: **61 cm**  
 The height of the legs: **12 cm**  
 The width of the side: **30 cm**



2.5VLe-OTM(11)SR, leather: color withdrawn from the offer



Movable seat



Bedding container



Movable headrests

## dimensions

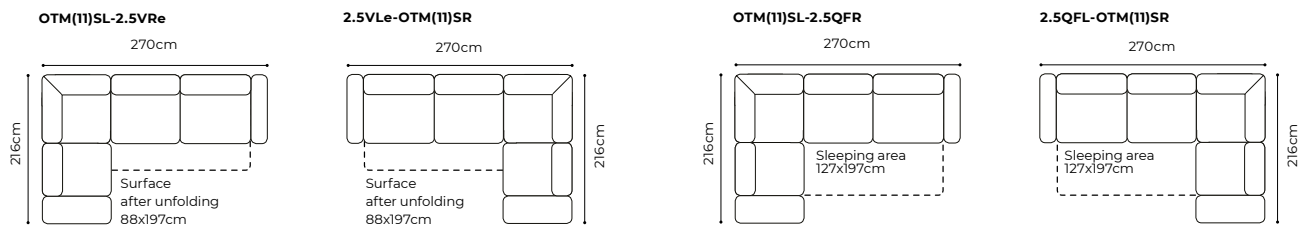

# GENOVA II

The height of the furniture: **90 cm**  
 The height of the seat: **44 cm**  
 The depth of the seat: **62 cm**  
 The height of the legs: **25 cm**  
 The width of the side: **13 cm**



TD, 2 and 3, leather G-4870 Massif Armagnac



Movable backrest with Automatic Return System



Platform legs

## dimensions

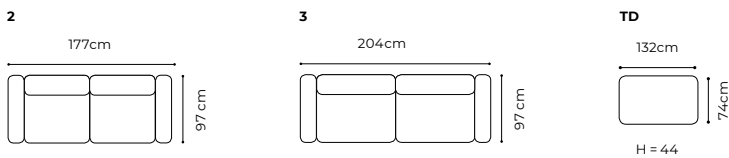



# MANTUA II

The height of the furniture: **75 cm** (with the headrest folded)  
**94 cm** (with the headrest unfolded)  
 The height of the seat: **45 cm**  
 The depth of the seat: **61 cm**  
 The height of the legs: **12 cm**  
 The width of the side: **30 cm**



2.5VLe-OTM(4)R, leather G-000



Movable headrests



Movable seat

**OTM(11)SL-2.5QFBB-1D(9)SR**

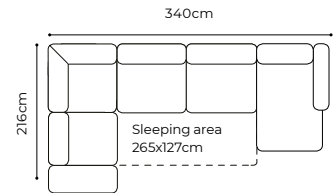

**1D(9)SL-2.5QFBB-OTM(11)SR**

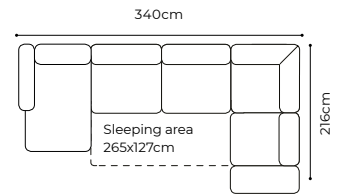

## dimensions

**OTM(4)L-2.5VRe**

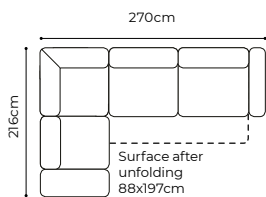

**2.5VLe-OTM(4)R**

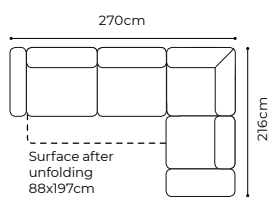

**OTM(11)SL-2.5QFR**

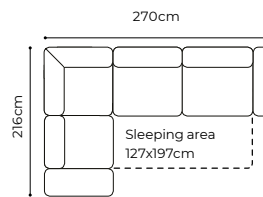

**2.5QFL-OTM(11)SR**

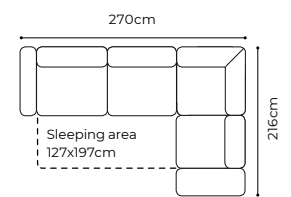

**2.5VL-1D(9)SR**

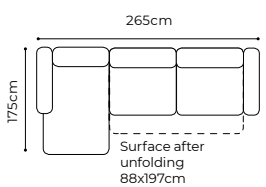

**2.5QFL-1D(9)SR**

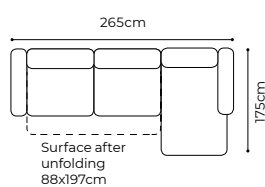

**1D(9)SL-2.5QFR**

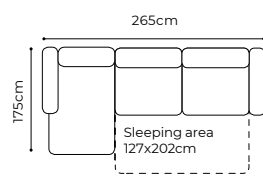

**2.5QFL-1D(9)SR**

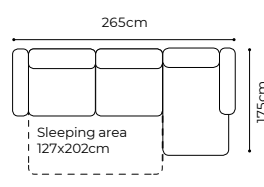

# MERANO II

The height of the furniture: **82 cm** (without headrest)  
**102 cm** (with optional headrest)  
 The height of the seat: **46 cm**  
 The depth of the seat: **60 cm**  
 The height of the legs: **15 cm**  
 The width of the side: **20 cm**



TB, 2.5Ve+2xZAG and 1+ZAG, fabric Supreme 144

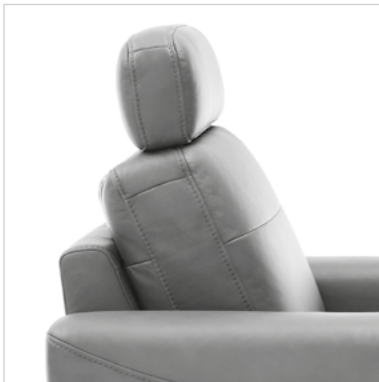

Optional headrest



Movable seat



Selection of leg type (black metal or chrome)

## dimensions

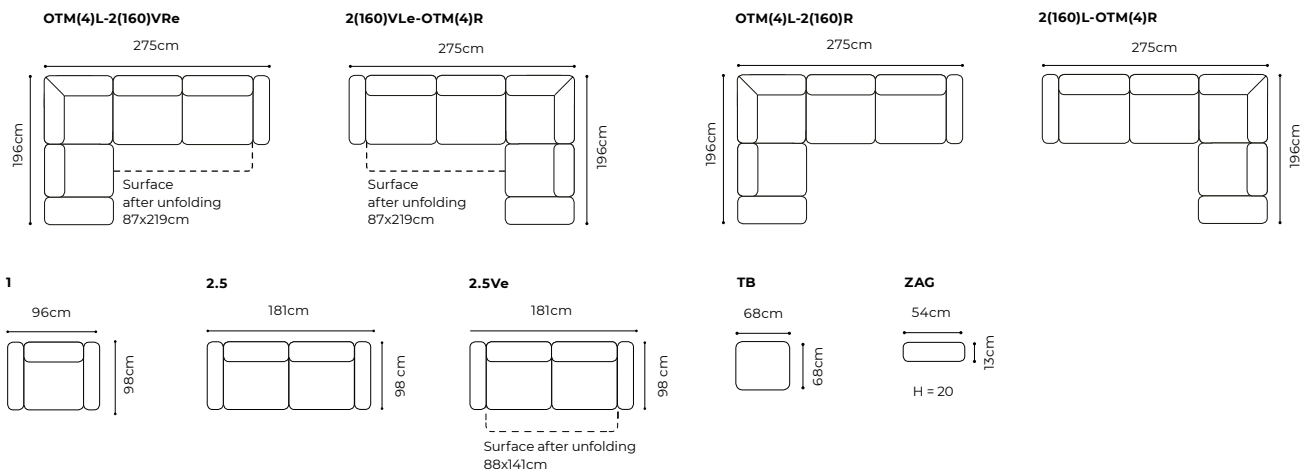

# NICEA

The height of the furniture: **87 cm** (without headrest)  
**104 cm** (with optional headrest)  
 The height of the seat: **48 cm**  
 The depth of the seat: **60 cm**  
 The height of the legs: **20 cm**  
 The width of the side: **20 cm**



1+ZAG, 2+2xZAC, leather G-4885 Granada Cogniac



Optional headrest



Selection of base type



Chaise longue

## dimensions

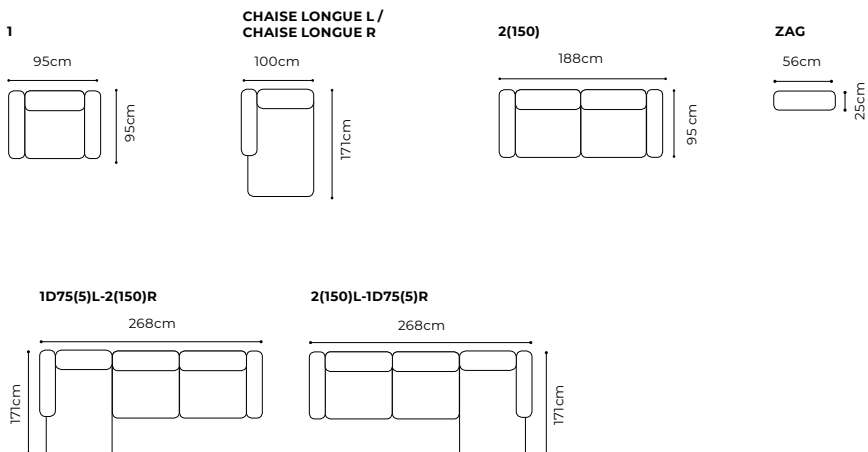





1+ZAG and 2+2xZAG, leather G-4885 Granada Cogniac

# PABLO

The height of the furniture: **87-107 cm**  
 The height of the seat: **47 cm**  
 The depth of the seat: **57 cm**  
 The depth of the seat (1): **60 cm**  
 The height of the legs: **20 cm**  
 The width of the side: **21 cm**



2(130)L-1D75(5)R, fabric Power 14



Movable headrest



1

## dimensions

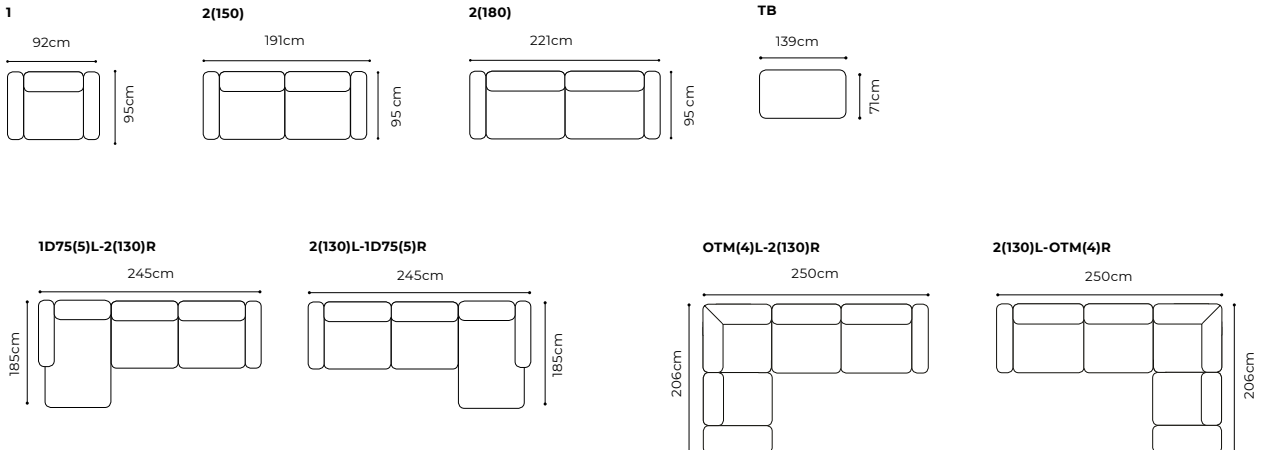

# VENETO

The height of the furniture: **90 cm**  
 The height of the seat: **48 cm**  
 The depth of the seat: **67 cm**  
 The height of the legs: **12 cm**  
 The width of the side: **25 cm**



1D(1)L-2.5FR, fabric Napoli 12



Sleeping function DL



Bedding container

## dimensions

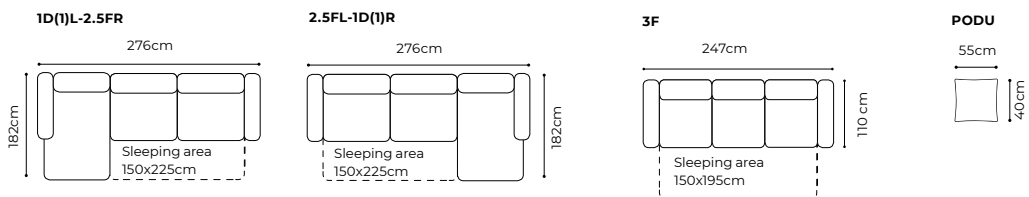







# BELLUNO



The height of the furniture: **78 cm** (with the headrest folded)  
**97 cm** (with the headrest unfolded)  
 The height of the seat: **46 cm**  
 The depth of the seat: **55 cm**  
 The height of the legs: **3 cm**  
 The width of the side: **32 cm**  
 The width of the side (1): **25 cm**



2.5QFL-SSEII-KER, fabric Mystic 68



Sleeping function Delfin



Sleeping function Sedalift



Movable headrest



Bedding container at 1D(10)SL/1D(10)SR



Bedding container at KEL/KER



Mobile pouffe with a container

basic system elements

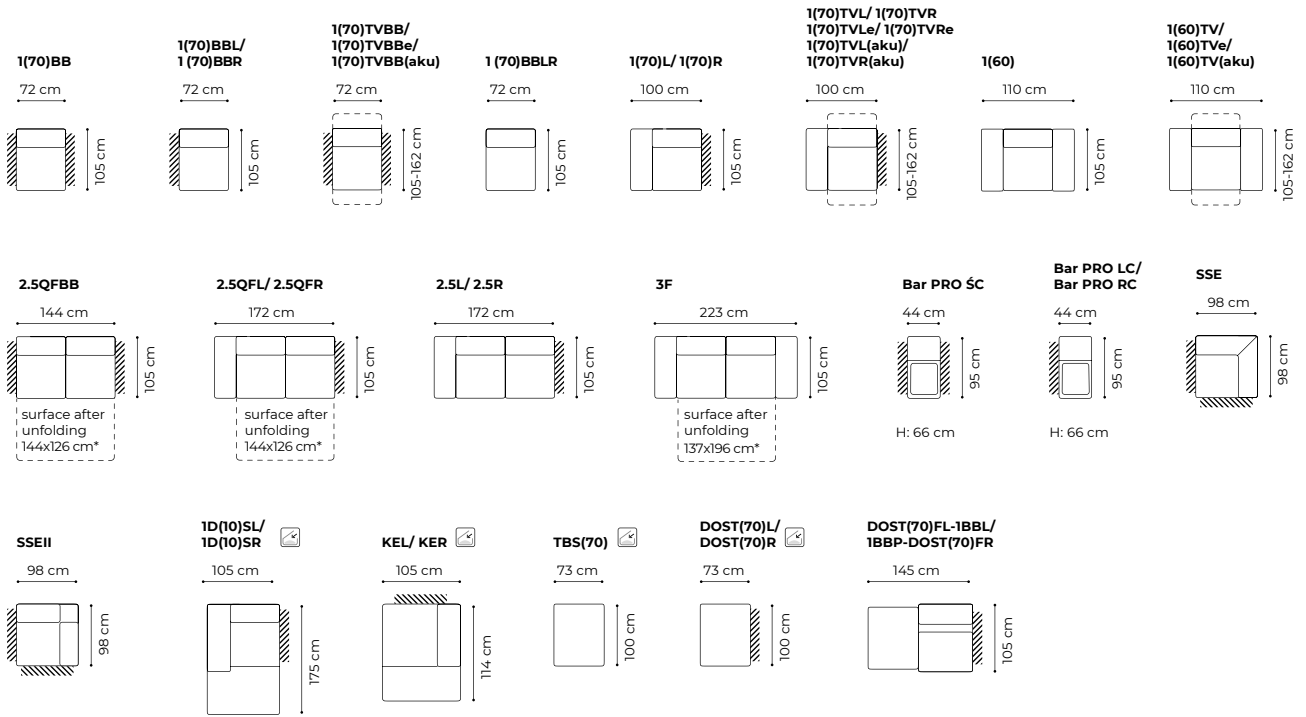

\*The eventual size of sleeping area depends on the type of the body, which you will add to the body with the sleeping function

example configurations

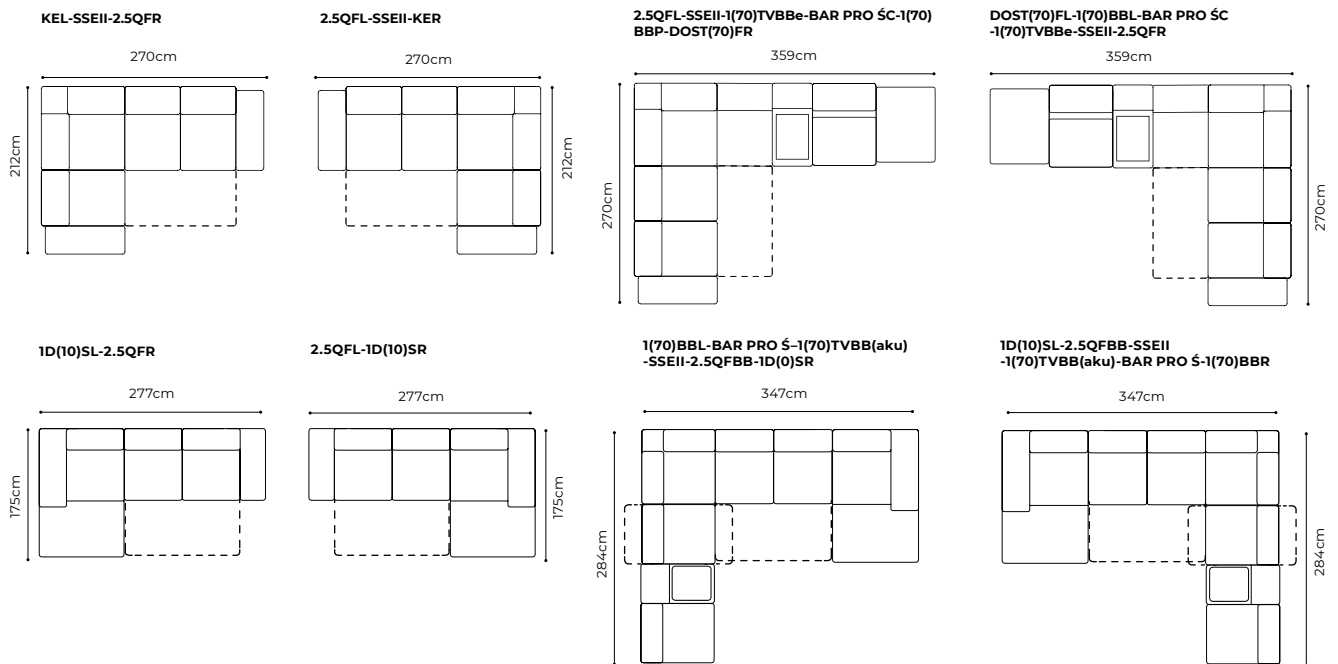

Mobile pouffe with a container



Liquor cabinet with a shifted top



Relaxation function

# CALPE

The height of the furniture: **82 cm** (with the headrest folded)  
**103 cm** (with the headrest unfolded)  
 The height of the seat: **47 cm**  
 The depth of the seat: **61 cm**  
 The height of the legs: **5 cm**  
 The width of the side: **16 cm**

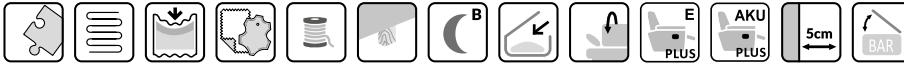

2.5FL-EN(2)-1(70)TVBB(aku)-BAR(2)ŠC-KE70(2)SR, leather: color withdrawn from the offer



Sleeping function Leopard



Bedding container



Relaxation function



Movable headrest



Liquor cabinet with a shifted top



Liquor cabinet with a shifted top

basic system elements

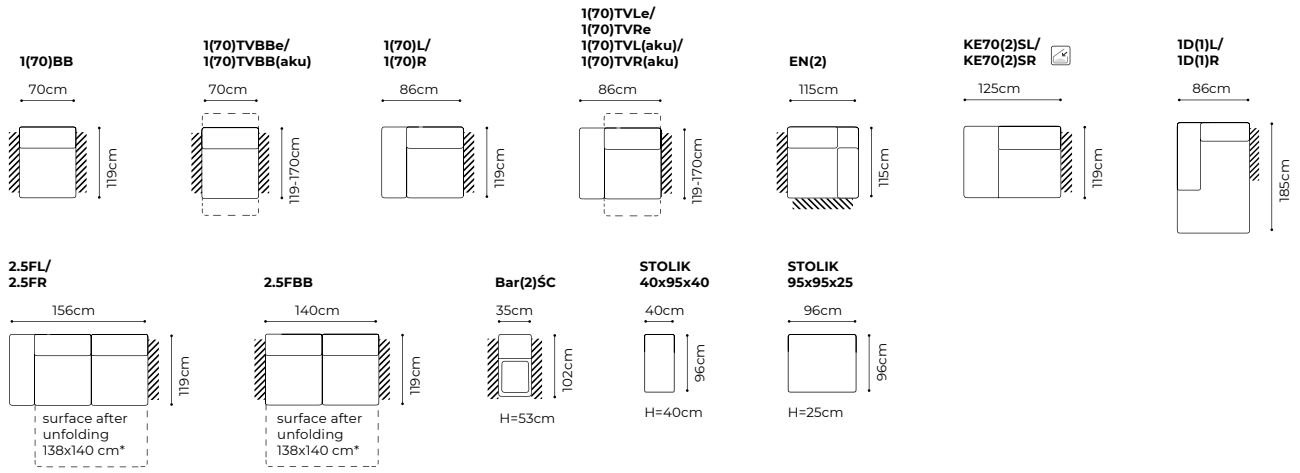

\*The eventual size of sleeping area depends on the type of the body, which you will add to the body with the sleeping function

example configurations

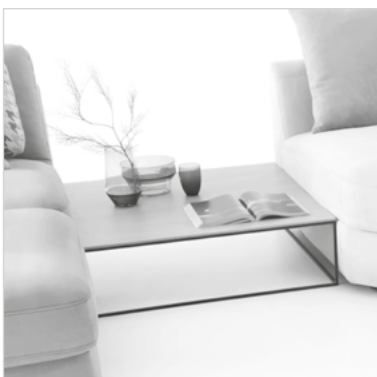
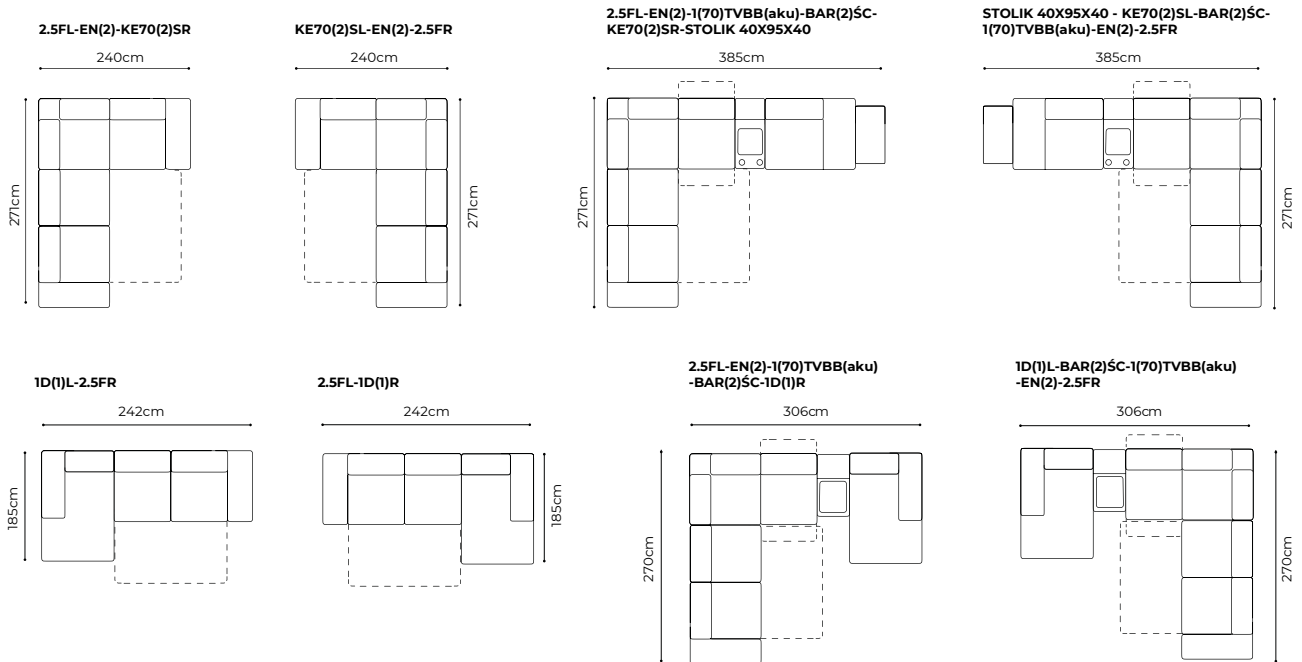

Stolik 95x95x25



stolik 40x95x40

# CANTATA

The height of the furniture: **83 cm** (with the headrest folded)  
**103 cm** (with the headrest unfolded)  
 The height of the seat: **45 cm**  
 The depth of the seat: **59 cm**  
 The height of the legs: **5 cm**  
 The width of the side: **15 cm**



1(70)TVLe-BAR(11)ŚC-1(70)BB-EN(2)-2.5FBB-ID(1)SR, 1(70), fabric Crown Velvet 21



1D(1)SL-2.5FBB-EN(2)-1(70)BB-BAR(11)ŚC-1(70)TVRe, fabric Crown Velvet 21



Sleeping function Leopard



Liquor cabinet with a shifted top



Relaxation function

basic system elements

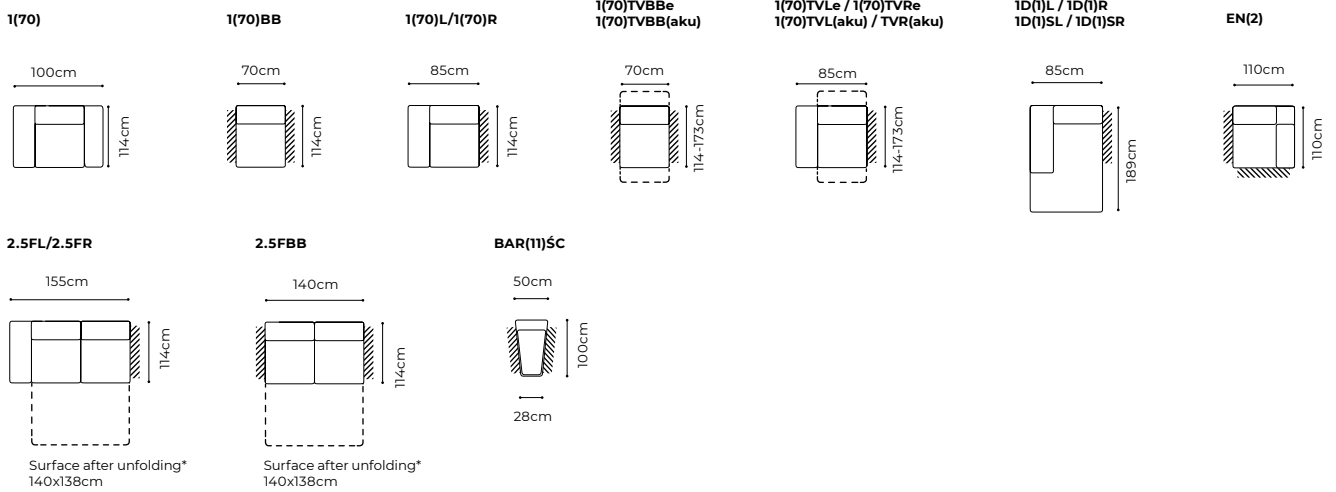

\*The eventual size of sleeping area depends on the type of the body, which you will add to the body with the sleeping function

example configurations

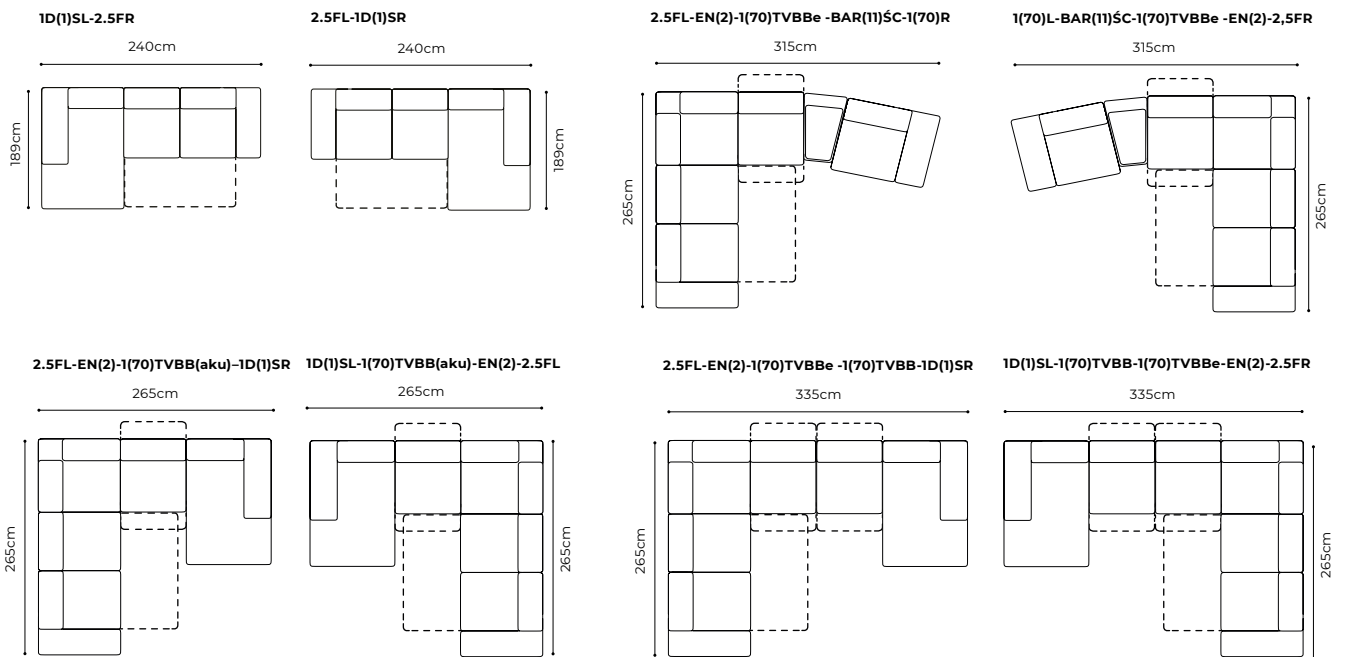

Movable headrest

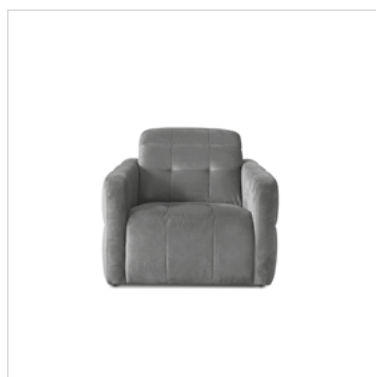

1



1 with the headrest unfolded

# CAPRI

The height of the furniture: **84 cm** (with the headrest folded)  
**97 cm** (with the headrest unfolded)  
 The height of the seat: **40 cm**  
 The depth of the seat: **57 cm**  
 The height of the legs: **5 cm**  
 The width of the side (1): **19 cm**  
 The width of the side: **35 cm** (other elements)



2FL-OTMSRC, leather G-2740, cushions - fabric Magu Jet 206, legs and shelf in wenge colour



Sleeping function Leopard



Bedding container



Corner with standard back cushions



Corner with 3 loose cushions

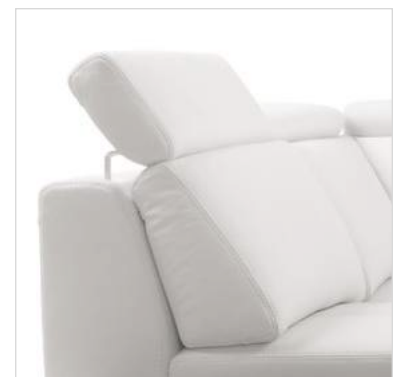

Movable headrest



basic system elements

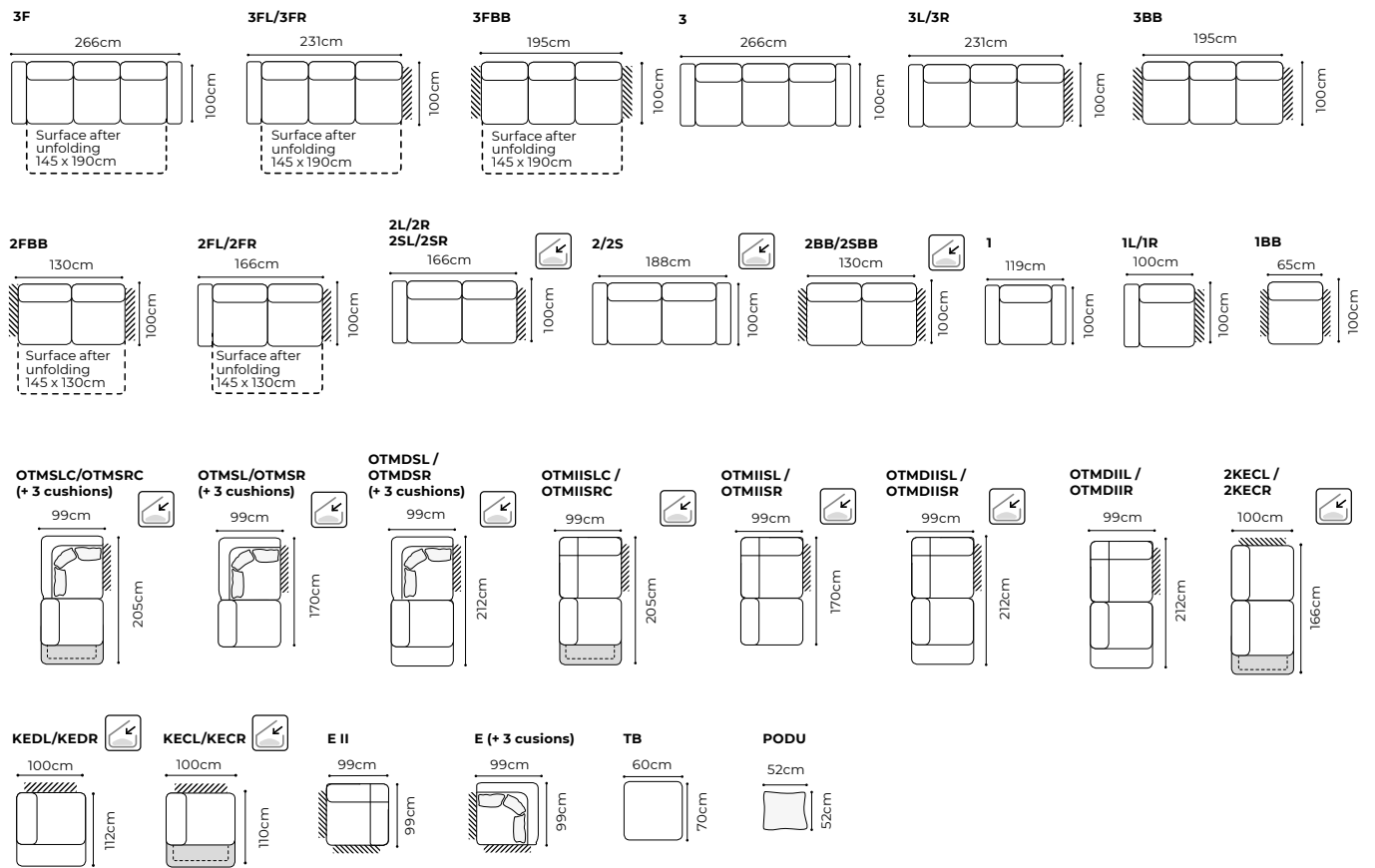

example configurations

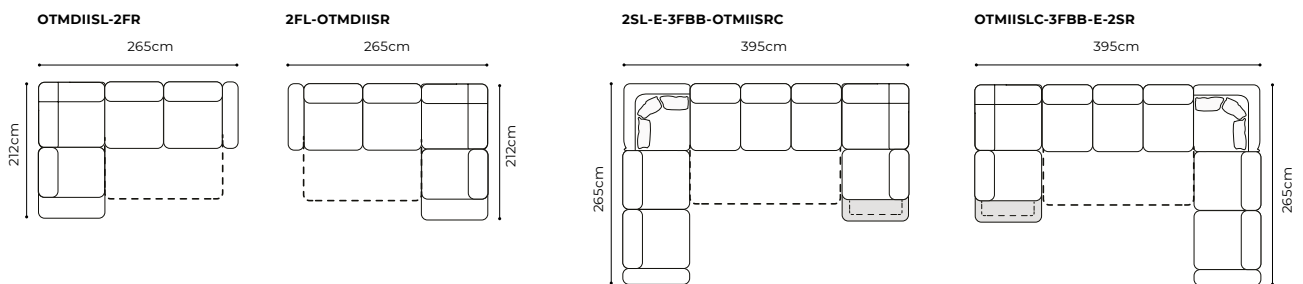

An extended seat



Side with armrest



With a lower wooden shelf





# DOMO

The height of the furniture: **81 cm** (with the headrest folded)  
**105 cm** (with the headrest unfolded)  
 The height of the seat: **47 cm**  
 The depth of the seat: **53 cm**  
 The height of the legs: **5 cm**  
 The width of the side: **33 cm** (standard)  
**26 cm** (narrow)



2.5FL-EN(2)-1(70)TVBB-BAR(9)ŠC-1D(5)SR, leather G-2855



1D(5)SL-2.5FR, leather G-2855



Sleeping function Leopard



Bedding container



Relaxation function

basic system elements

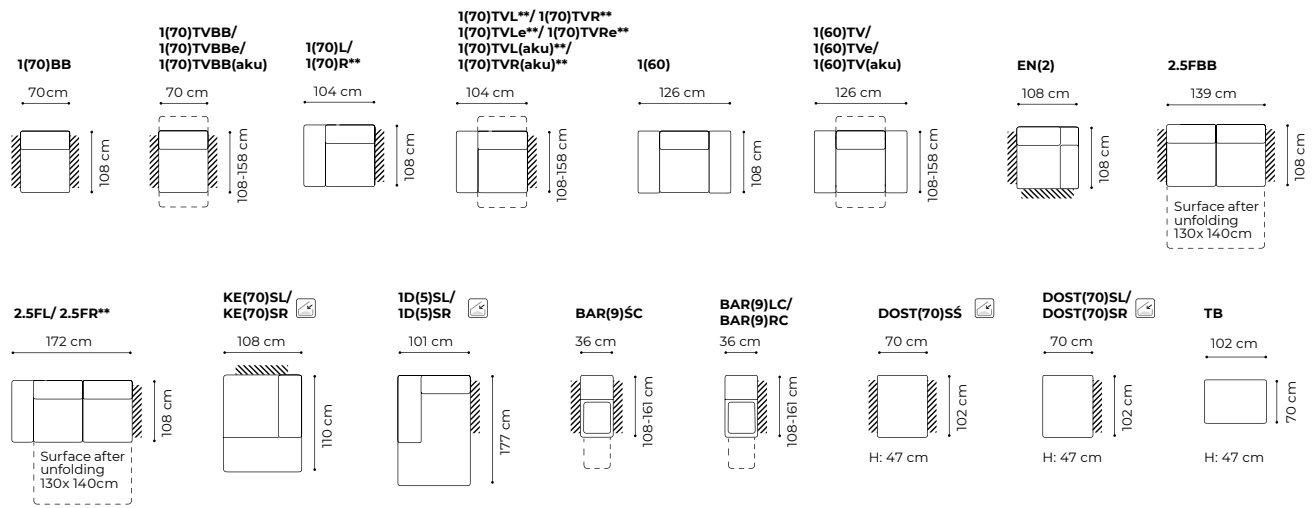

\*The eventual size of sleeping area depends on the type of the body, which you will add to the body with the sleeping function

\*\* Body available with a side in two widths: standard: 33 cm, narrow: 23 cm. The drawings show the width of the body with a standard side.

example configurations

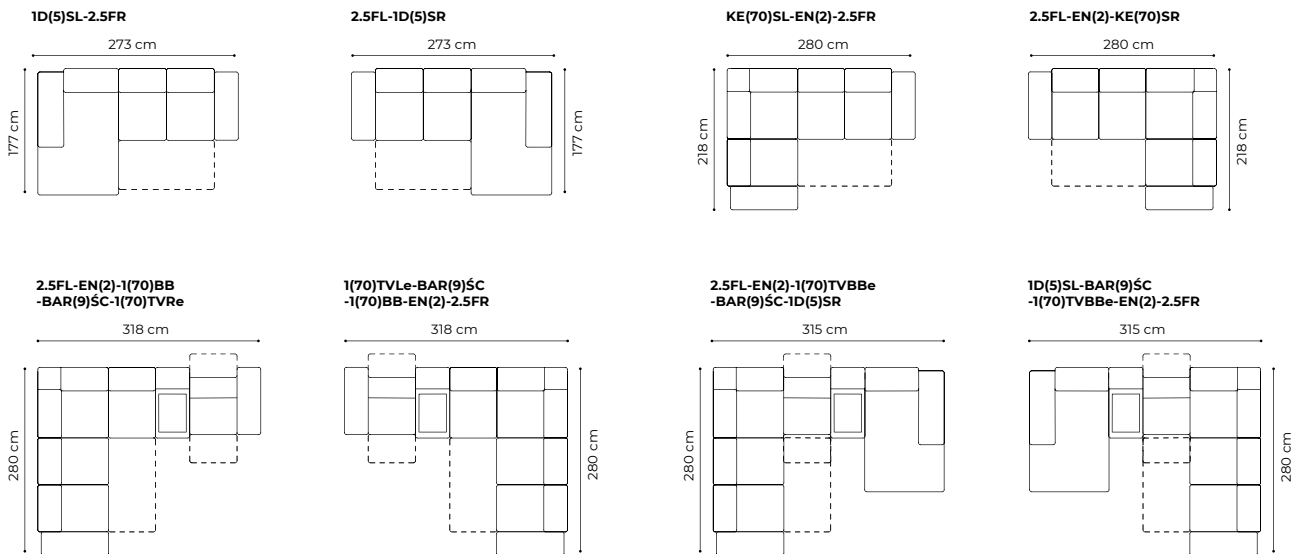

Movable headrest



Liquor cabinet with a pullout drawer and a wooden top



Standard side (33 cm) and narrow side (23 cm)

# GIRRO

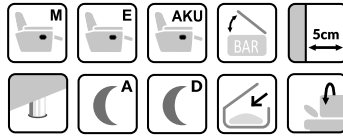

The height of the furniture: **76 cm** (with the headrest folded)  
**98 cm** (with the headrest unfolded)  
 The height of the seat: **46 cm**  
 The depth of the seat: **54 cm**  
 The height of the legs: **2,5 cm**  
 The width of the side (1(6o) / 1(6o)TV): **27 cm**  
 The width of the side: **34 cm (A) or 27 cm (B)**



BL(A)-3QFBB-SSEII-1(80)TVBB-BAR(6)ŠC-1D(4)SR, leather G-2110



BL(A)-2.5QFBB-BR(A), leather G-2110



1D(4)SL-3FBB-BR(A), leather G-2110



Sleeping function Delfin



Liquor cabinet with a cubbyhole and a pullout drawer



Optional headrest

basic system elements

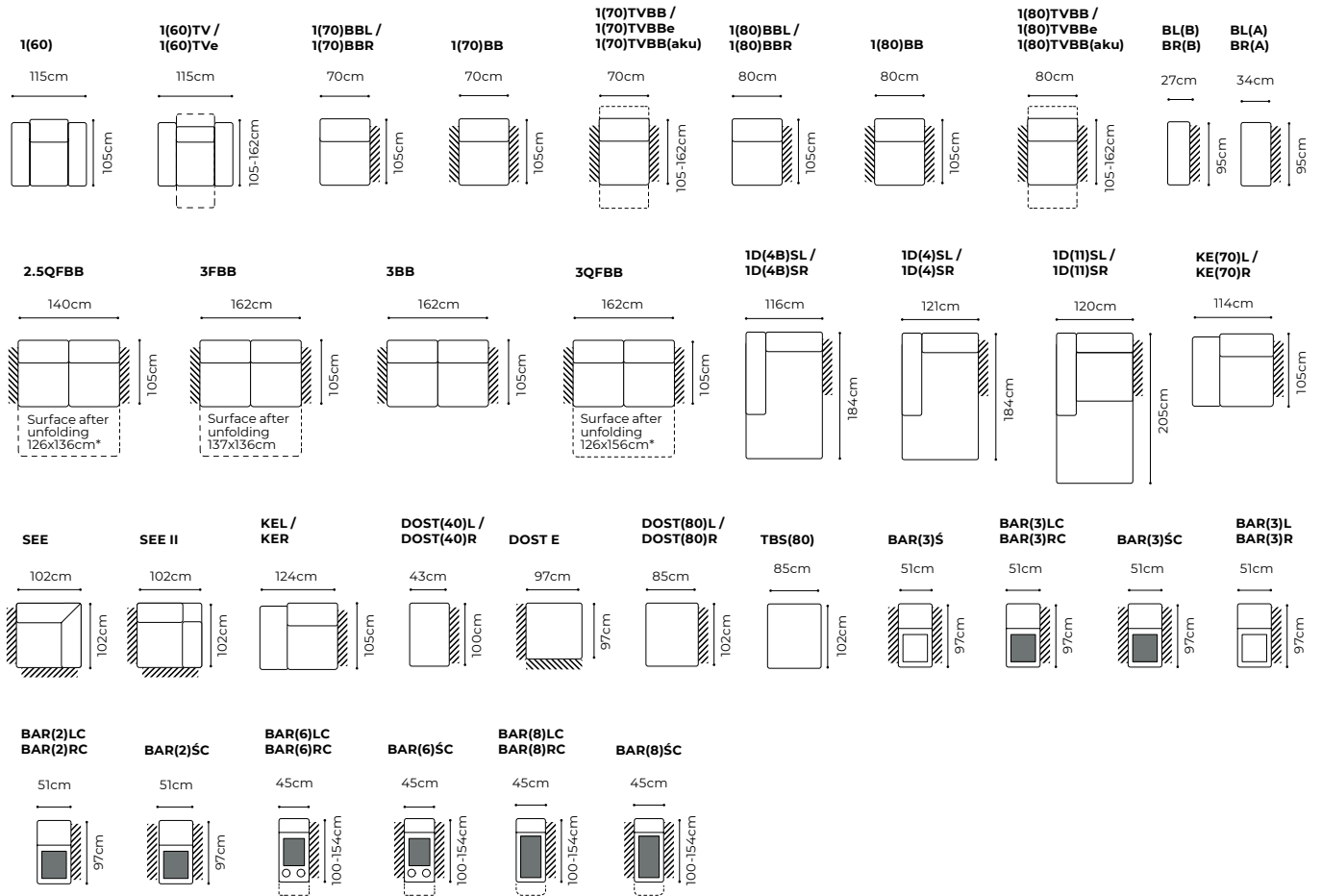

\*The eventual size of sleeping area depends on the type of the body, which you will add to the body with the sleeping function

example configurations

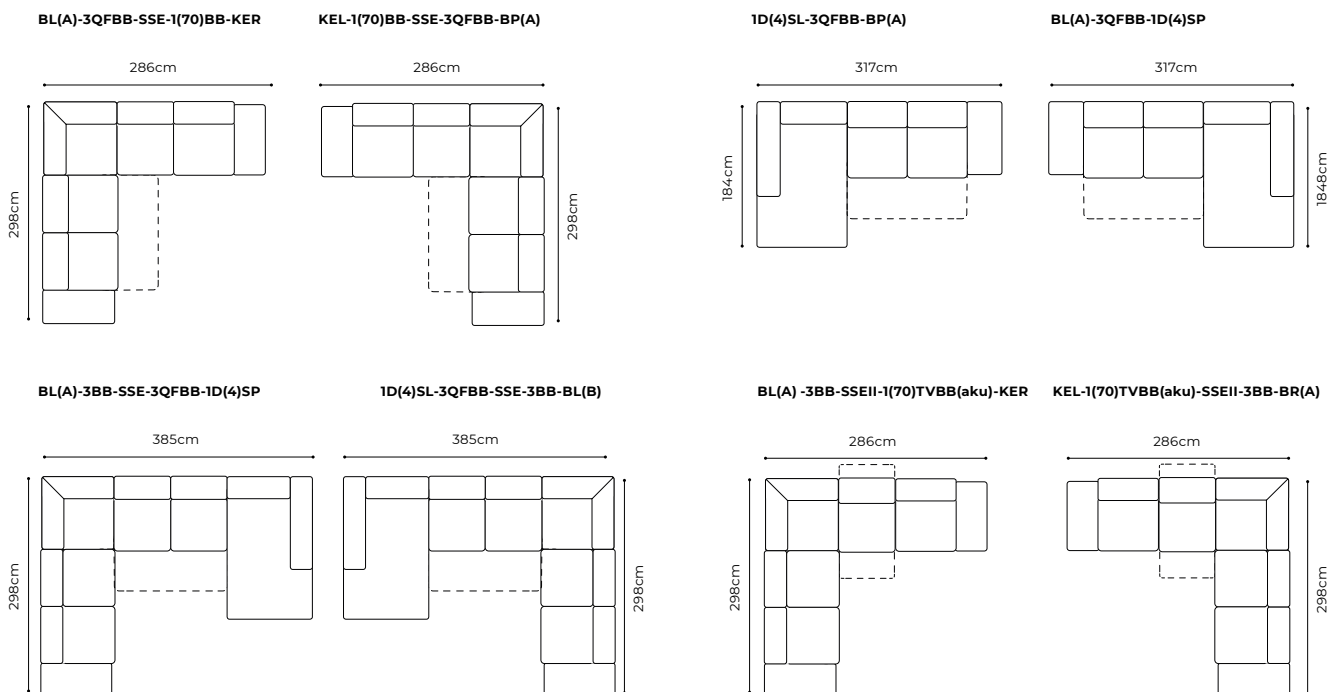

# KARATO

The height of the furniture: **89 cm**  
 The height of the seat: **46 cm**  
 The depth of the seat: **60 cm**  
 The height of the legs: **5 cm**  
 The width of the side: **22 cm**

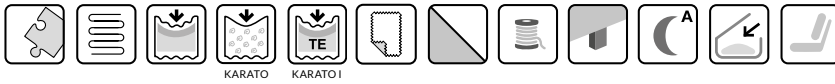

1(80)L-1(80)BB-EN(2)-3QFBB-ID(5)SR, fabric Crown Velvet 35 + 6xPODU Crown Velvet 35/Crown Velvet 10



1D(5)SL-3QFBB-EN(2)-1(80)BB-1(80)R, fabric Crown Velvet 35 + 6xPODU Crown Velvet 35/Crown Velvet 10



Sleeping function Delfin



Bedding container



Optional cushions



basic system elements

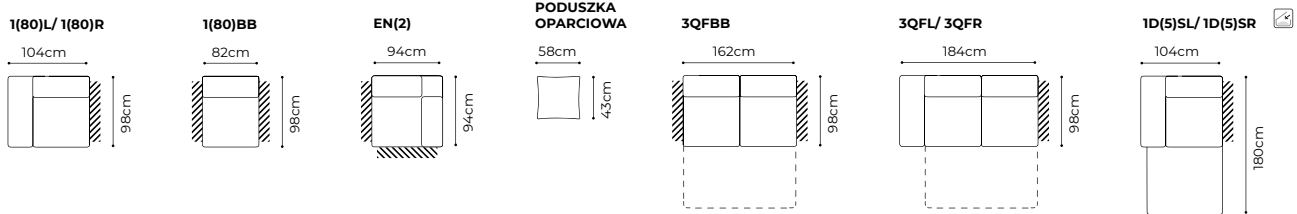

\*The eventual size of sleeping area depends on the type of the body, which you will add to the body with the sleeping function

All elements can be free-standing or combined with each other. Ask your salesperson in the showroom how to configure the given piece of furniture with a full-size sleeping surface.

example configurations

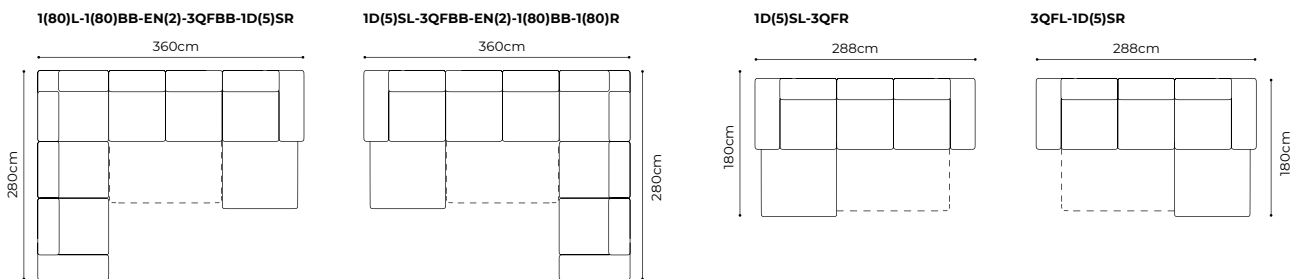

3QFL-1D(5)SP, fabric Mystic 68

# LUCIANO

The height of the furniture: **76 cm** (with the headrest folded)  
**98 cm** (with the headrest unfolded)  
 The height of the seat: **46 cm**  
 The depth of the seat: **55 cm**  
 The height of the legs: **3 cm**  
 The width of the side (1): **28 cm**  
 The width of the side: **35 cm**



IDFL-2.5QFBB-SSE-1(70)TVBB(aku)-DOST(80)Ś-1R, fabric Mystic 105



Sleeping function Delfin



Bedding container



Relaxation function



Liquor cabinet



Liquor cabinet with a cubbyhole and a pullout drawer



Movable headrest

basic system elements

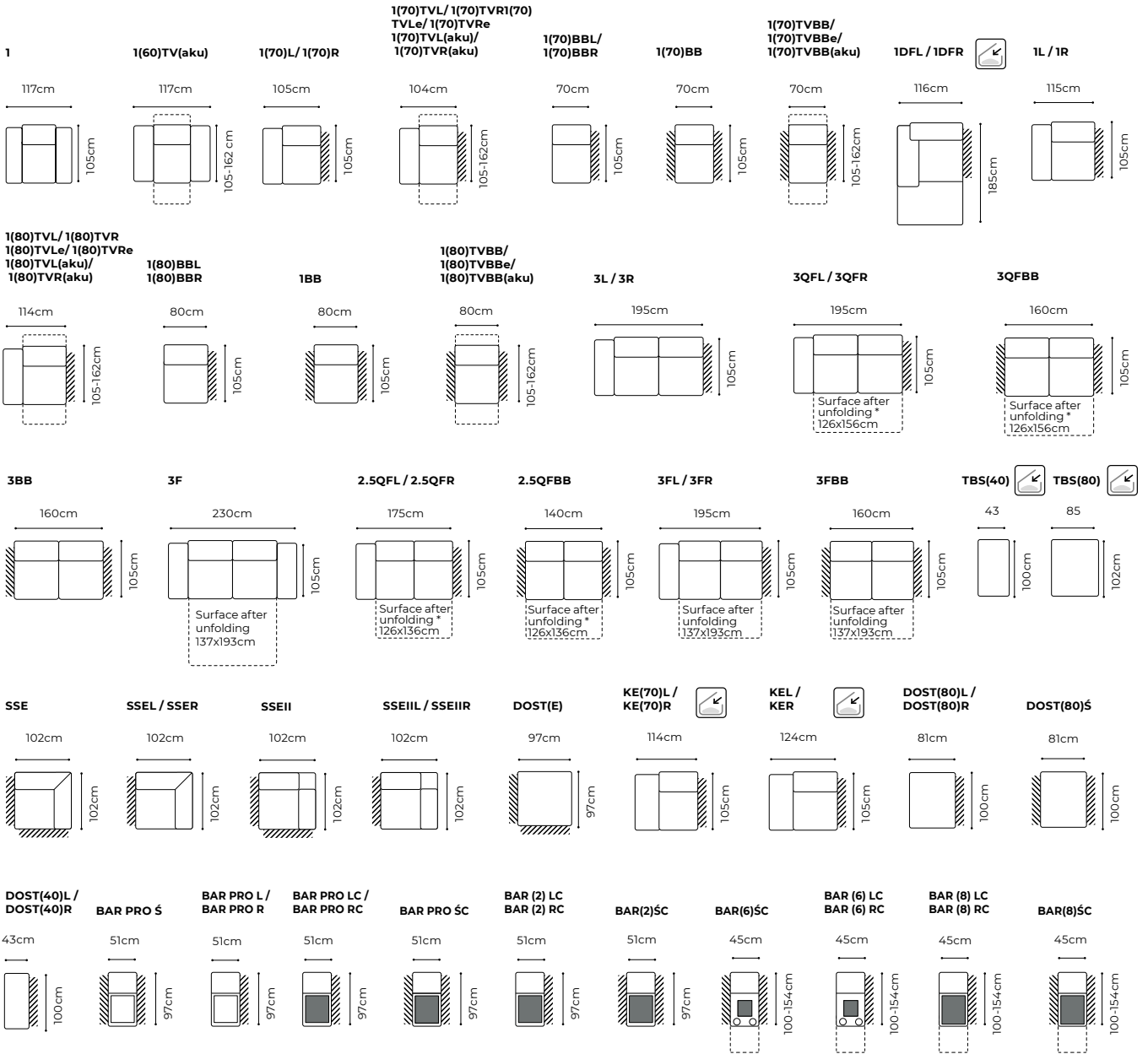

\*The eventual size of sleeping area depends on the type of the body, which you will add to the body with the sleeping function

example configurations

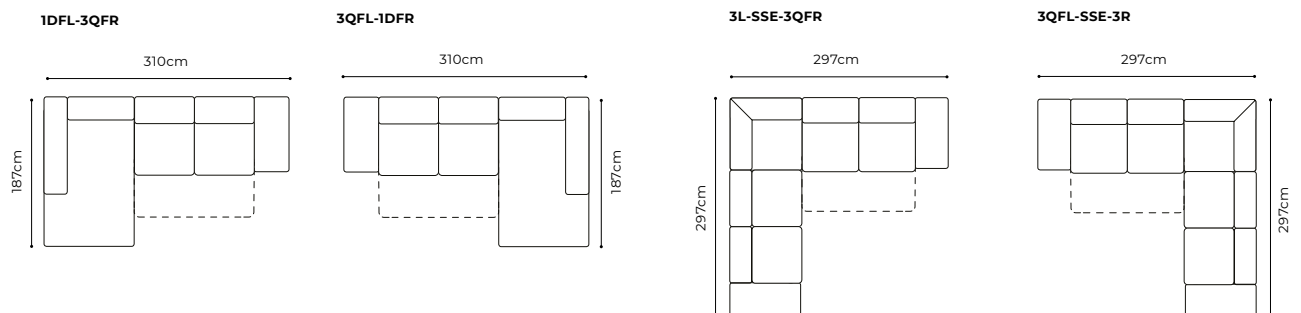

# MASSIMO



The height of the furniture: **78 cm** (with the headrest folded)  
**99 cm** (with the headrest unfolded)  
 The height of the seat: **46 cm**  
 The depth of the seat: **56 cm**  
 The height of the legs: **3 cm**  
 The width of the side: **21 cm**



1D(1)SL-BAR(2)ŠC-1(70)TVBBE-EDŠL-2.5QFR, leather G-654



Sleeping function Delfin



Bedding container



Bedding container



Movable headrest



Movable seat



Relaxation function

basic system elements

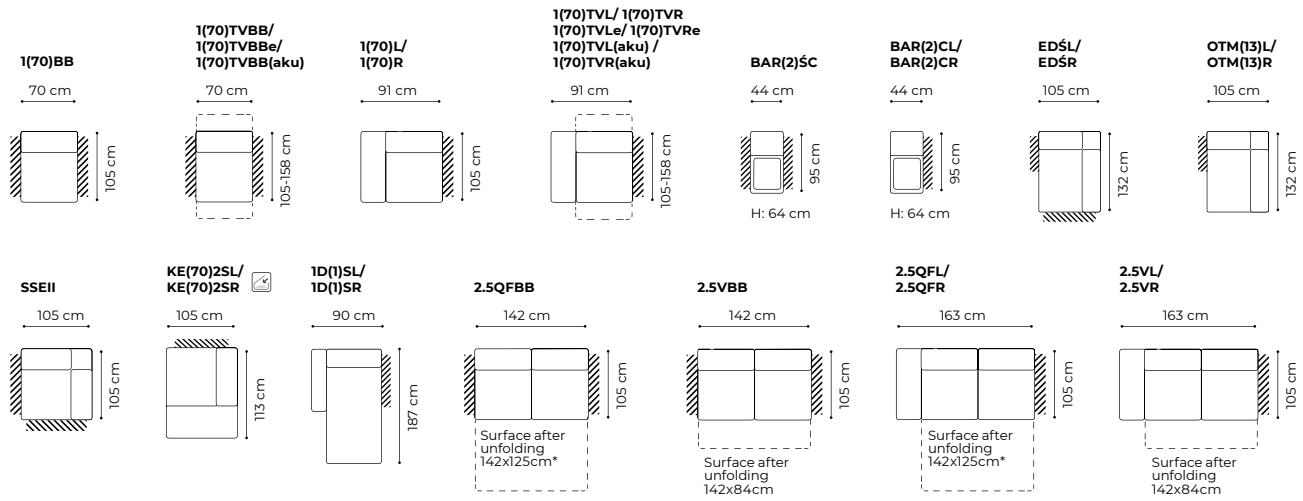

\*The eventual size of sleeping area depends on the type of the body, which you will add to the body with the sleeping function

example configurations

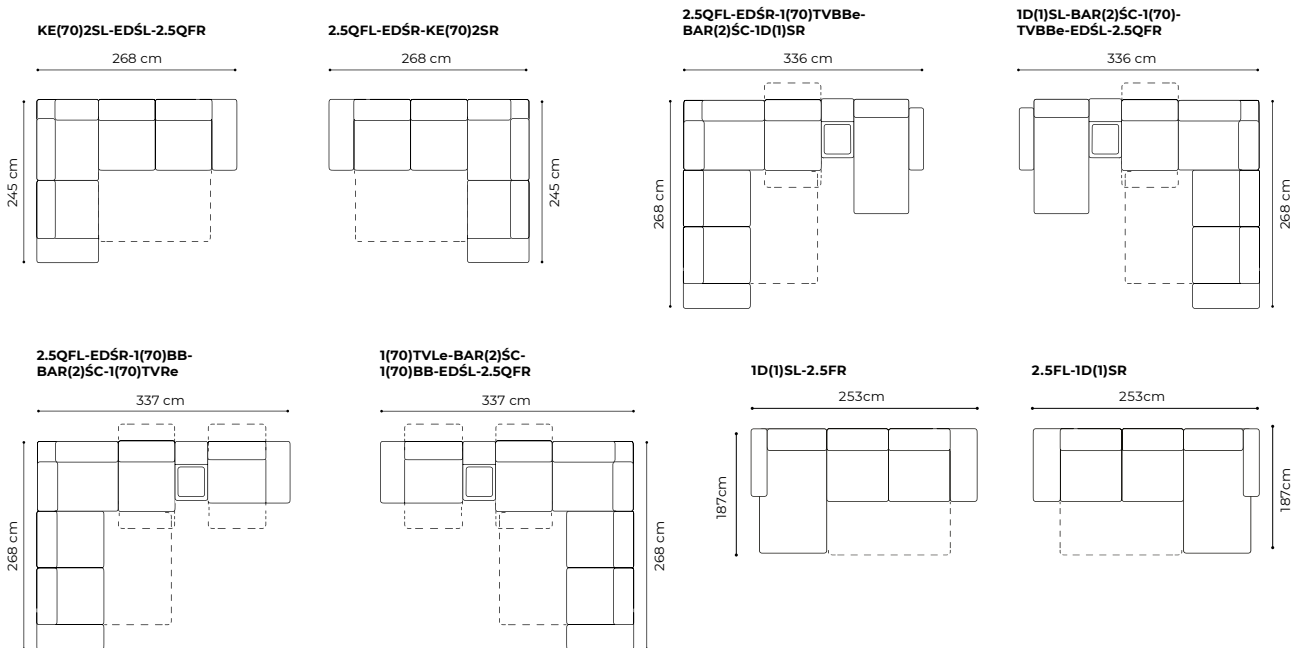

Liquor cabinet



Liquor cabinet





# MERIDA

The height of the furniture: **68/87 cm** (with cylindrical headrest)  
**68/105 cm** (with oblong cushion headrest)  
 The height of the seat: **48 cm**  
 The depth of the seat: **49-88 cm**  
 The height of the legs: **5 cm**  
 The width of the side: **22 cm**



1(120)QFL-1D100(2)SR, fabric Veliero 22



1(120)QFL-EN(2)-1(80)BB-STOLIK(40),  
 fabric Elba 38, Roja 08 and Vedra 07



1KL-STOLIK(40)-1(120)QFR,  
 fabric Elba 38, Roja 08 and Vedra 07



Sleeping function Leopard



Bedding container



Liquor cabinet



basic system elements

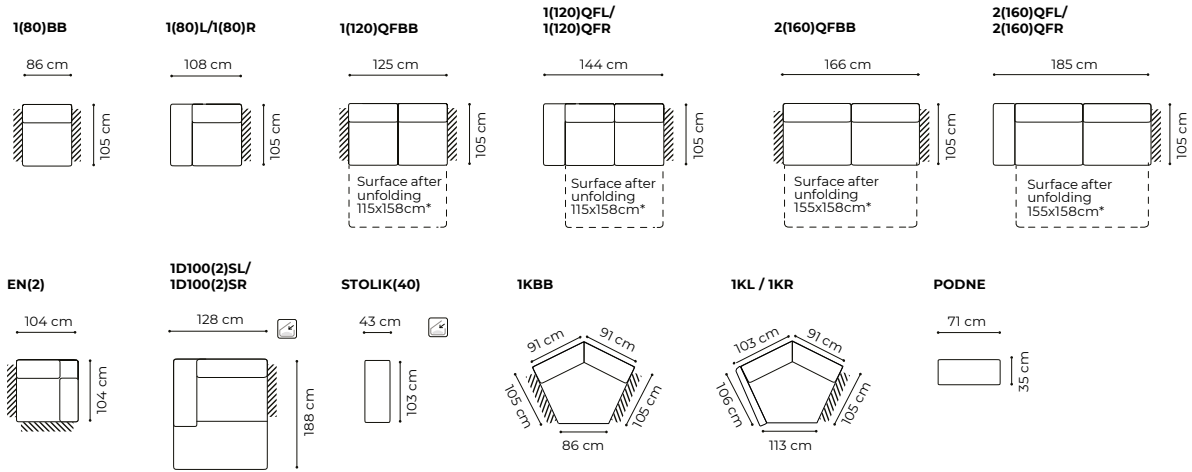

\*The eventual size of sleeping area depends on the type of the body, which you will add to the body with the sleeping function

All elements can be free-standing or combined with each other. Ask your salesperson in the showroom how to configure the given piece of furniture with a full-size sleeping surface.

example configurations

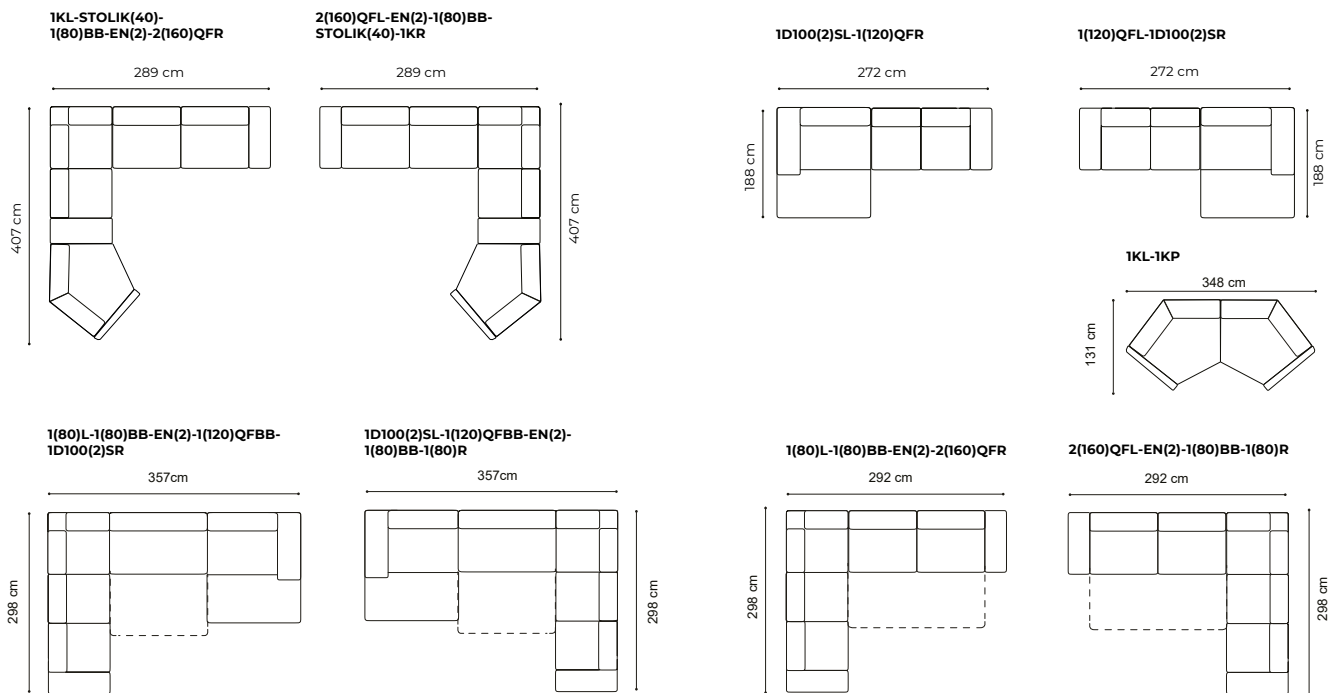

Cylindrical headrest



Cylindrical headrest



Oblong cushion headrest

# MEZZANA

The height of the furniture: **79 cm** (with the headrest folded)  
**94 cm** (with the headrest unfolded)  
 The height of the seat: **47 cm**  
 The depth of the seat: **49 cm**  
 The height of the legs: **15 cm**  
 The width of the side: **20 cm**



2.5VLe-OTM(4)R, leather G-4870 MASSIF Armagnac, legs N02 oak



Movable headrests



Movable seat



TB

Selection of legs:



N01



N01



N02



N03



N04



N05

basic system elements

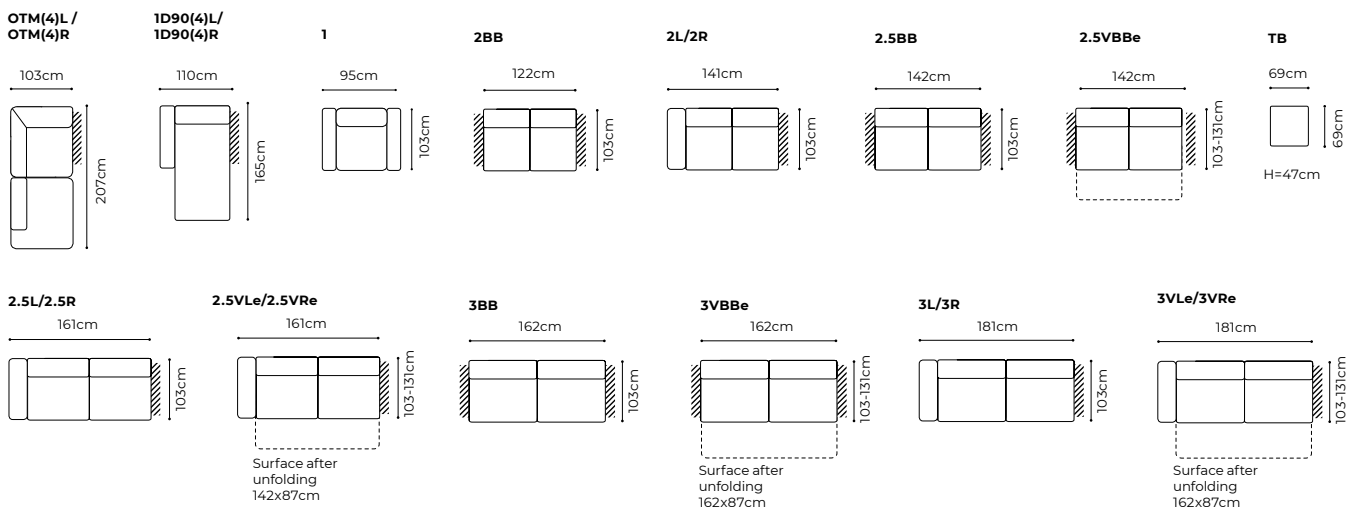

example configurations

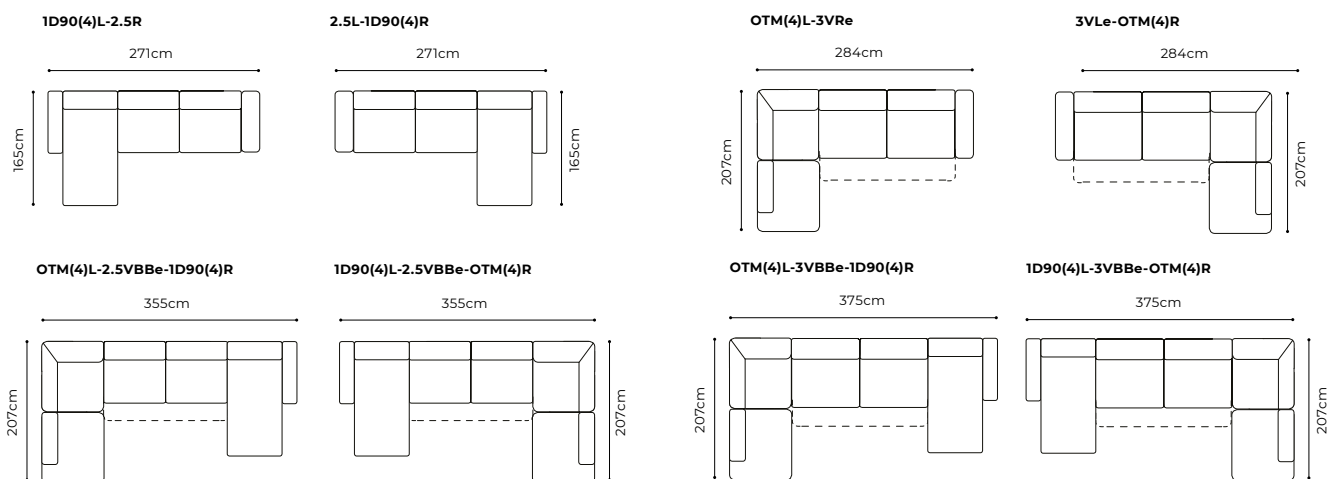

1D90(4)L-2.5VRe, leather G-4350 MASSIF RUBINO





# OVIEDO

The height of the furniture: **103 cm**  
 The height of the seat: **49 cm**  
 The depth of the seat: **56 cm**  
 The height of the legs: **5 cm**  
 The width of the side: **23 cm**



BL-1(90)TVBBE-BAR(5)ŚC-1(90)TVBBE-BR, leather G-4520 Massif Whale, wooden shelf - oak



BL-2(190)FBB-BR leather G-4520 Massif Whale



BL-1(90)TVBBE-BAR(5)ŚC-1(90)TVBBE-BR  
 leather G-4520 Massif Whale



Sleeping function Leopard



Relaxation function PLUS



Movable headrest

basic system elements

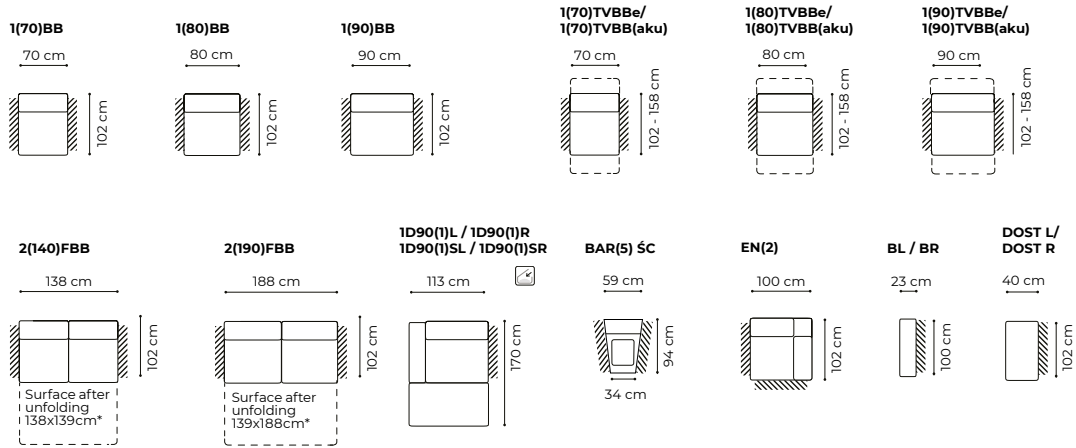

\*The eventual size of sleeping area depends on the type of the body, which you will add to the body with the sleeping function

example configurations

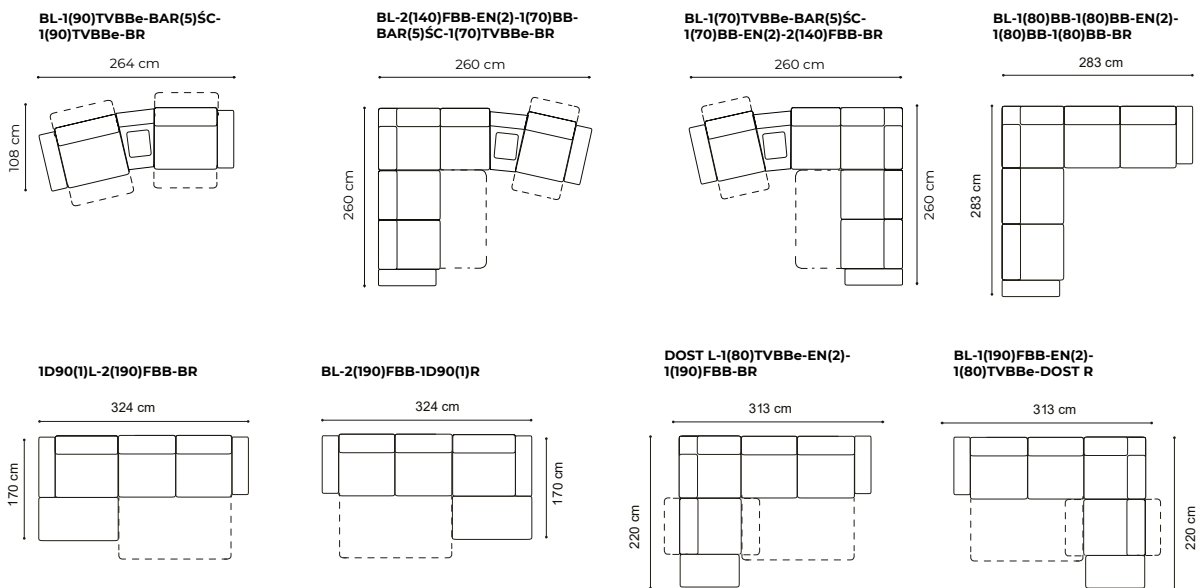

Liquor cabinet



Liquor cabinet







# PLAZA

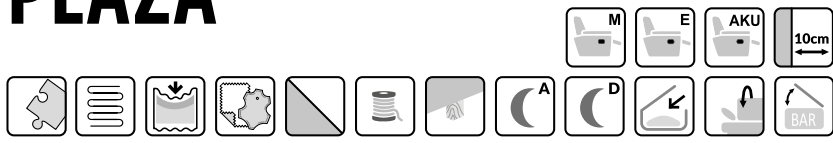

The height of the furniture: **76 cm** (with the headrest folded)  
**98 cm** (with the headrest unfolded)  
 The height of the seat: **44 cm**  
 The depth of the seat: **55 cm**  
 The height of the legs: **2,5 cm**  
 The width of the side (1): **28 cm**  
 The width of the side: **35 cm**



1DFL-3QFR, fabric CROWN 17



3QL-DOST(E)-1(80)BB-1(80)TVBBe-BAR PRO ŚC-1DFR,  
 fabric CROWN 17



Sleeping function Delfin



Bedding container



Relaxation function

basic system elements

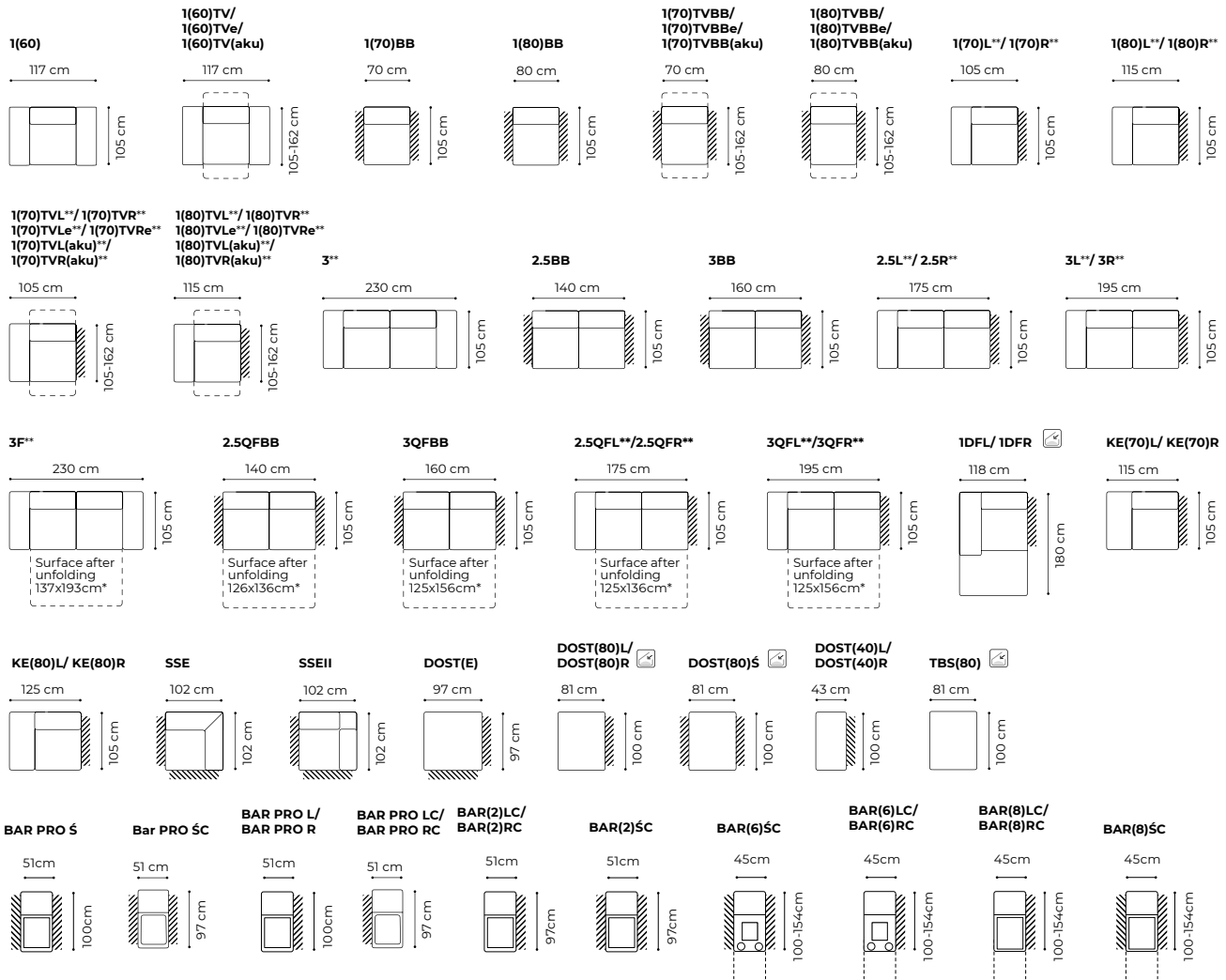

\*The eventual size of sleeping area depends on the type of the body, which you will add to the body with the sleeping function

\*\*Body available with a side in two widths: standard: 35 cm, narrow: 28 cm. Armchairs 1(6o), 1(6o)TV, 1(6o)TVe and 1(6o)TV(aku) - are available only with 28 cm wide sides.

example configurations

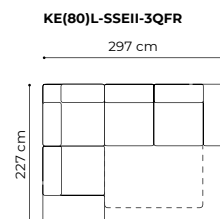
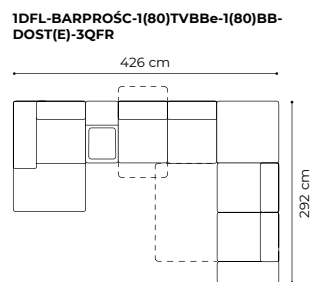
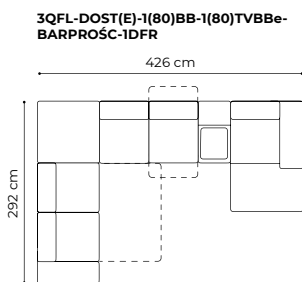

Movable headrests



Liquor cabinet



Liquor cabinet





# SERENA

The height of the furniture: **83 cm**  
 The height of the seat: **49 cm**  
 The depth of the seat: **79 cm**  
 The height of the legs: **2,8 cm**  
 The width of the side: **21 cm**



3QFBB-1(80)R and 1D(10)SL and STOLIK 40x106x40, fabric Sofia 17, medium cushions Dragonera 02, small cushions Vedra 02



1D(10)SL-STOLIK 106x106x25-EN(6)XL-3QFBB-EN(2)-1(80)BB- STOLIK 40x106x40-1(80)R, fabric Habana 05, Habana 25, cushions: Mirasol 09, Fonteta 09, Vinaros 09



Sleeping function Leopard



Bedding container



STOLIK 106x106x25

basic system elements

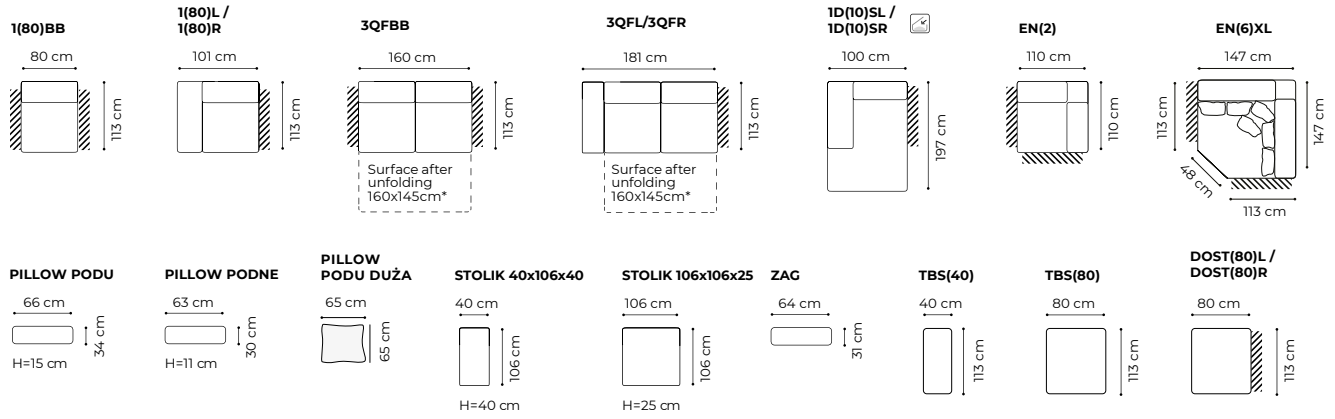

\*The eventual size of sleeping area depends on the type of the body, which you will add to the body with the sleeping function

All elements can be free-standing or combined with each other. Ask your salesperson in the showroom how to configure the given piece of furniture with a full-size sleeping surface.

example configurations



STOLIK 40x106x40



Corner with loose cushions

# TOLEDO

The height of the furniture: **100 cm**  
 The height of the seat: **48 cm**  
 The depth of the seat: **51 cm**  
 The height of the legs: **5 cm**  
 The width of the side: **34 cm**



3FL-E-1(80)TVBB-1(80)R, leather G-100



2, leather G-100



1(80)L-1(80)TVBB-E-3FR, leather G-100



Sleeping function Sedalift



Relaxation function

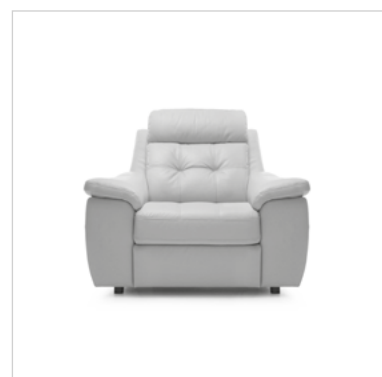

1



basic system elements

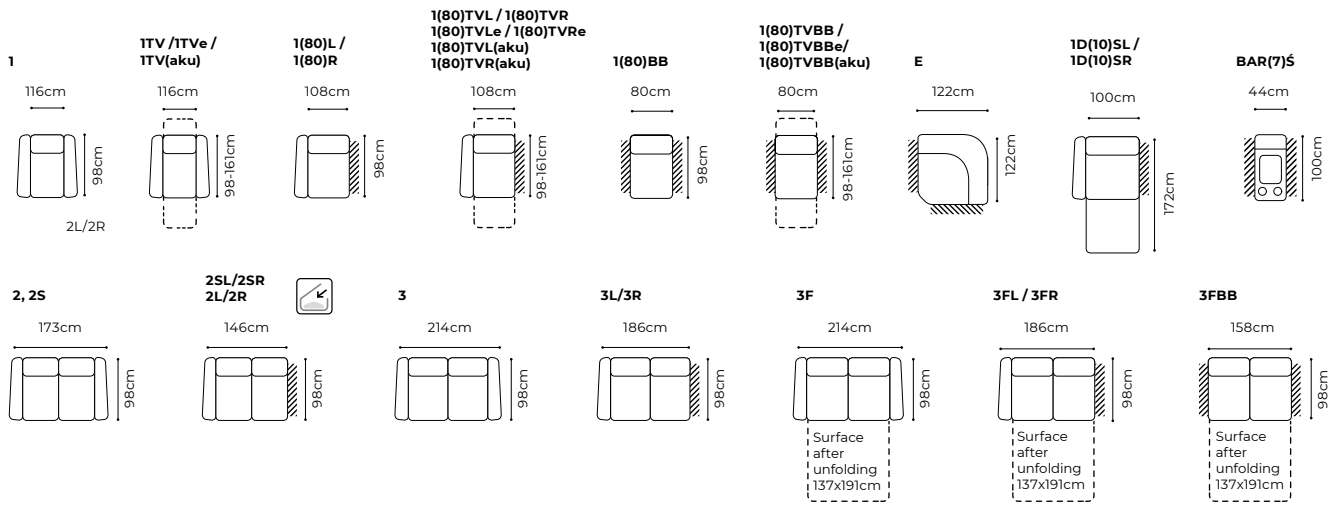

example configurations

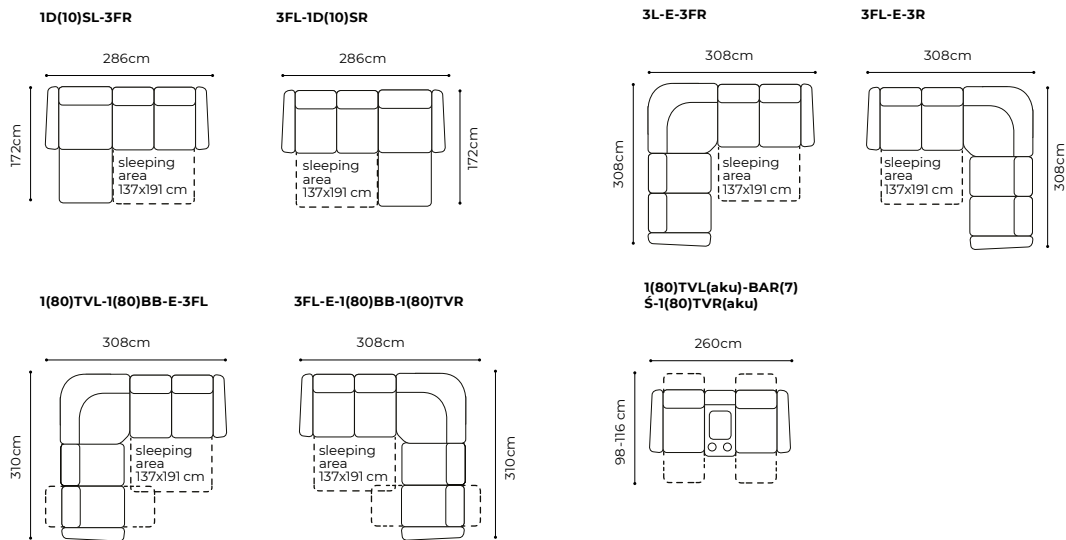





# VOLTA



The height of the furniture: **86 cm** (with the headrest folded)  
**106 cm** (with the headrest unfolded)  
 The height of the seat: **49 cm**  
 The depth of the seat: **58 cm**  
 The height of the legs: **10 cm**  
 The width of the side: **22 cm**



DOST(L)-1(70)BB-EN(2)-2(140)FBB-BAR(5)ŚC-1(90)TVBBe-BR, leather G-3165



DOST(L)-1(70)BB-EN(2)-2(140)FBB-1(90)TVBBe-BR, leather G-3165



Sleeping function Sedalift



Relaxation function



Movable headrests

basic system elements

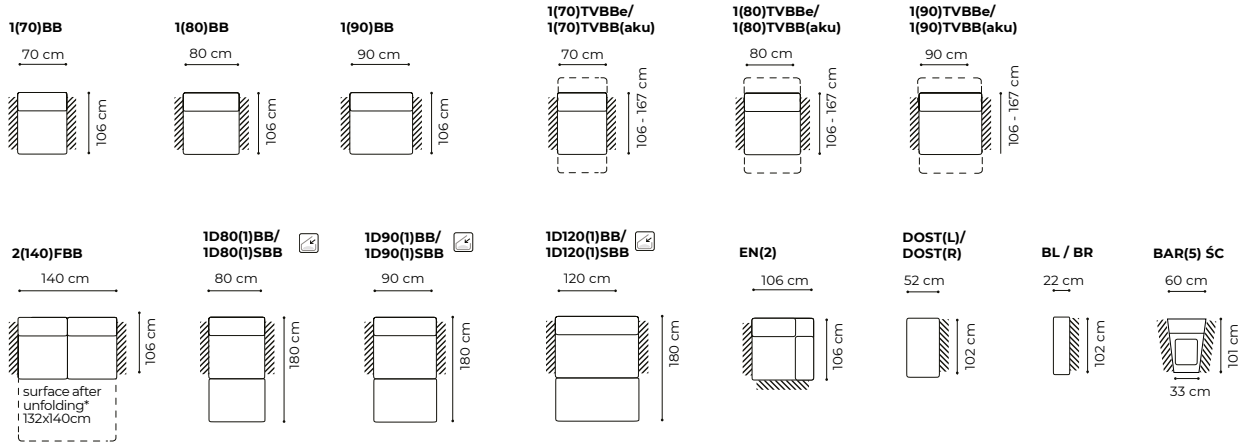

\*The eventual size of sleeping area depends on the type of the body, which you will add to the body with the sleeping function

example configurations

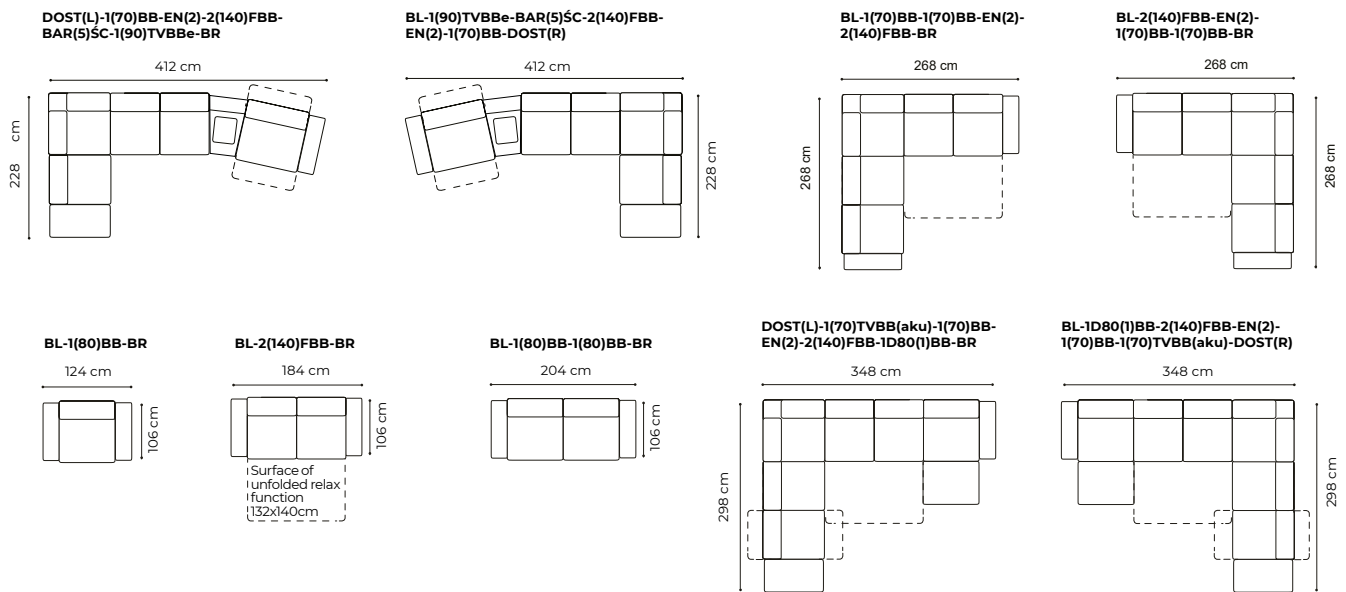

Liquor cabinet



Liquor cabinet



# FORLI

The height of the furniture: **105 cm**  
 The height of the seat: **47 cm**  
 The depth of the seat: **53 cm**  
 The height of the legs: **18 cm**  
 The width of the side: **18 cm**



3 and 1, fabric Baron 22 and Emoji 38



3



2

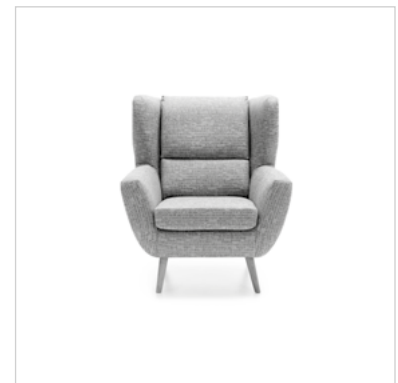

1

## dimensions

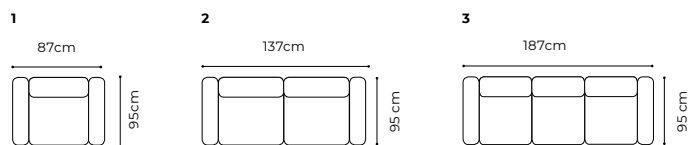

# SCANDI

The height of the furniture: **92 cm**  
 The height of the seat: **47 cm**  
 The depth of the seat: **53 cm**  
 The height of the legs: **18 cm**  
 The width of the side: **19 cm**



3 and 2 and 1, fabric Bellagio 242



3

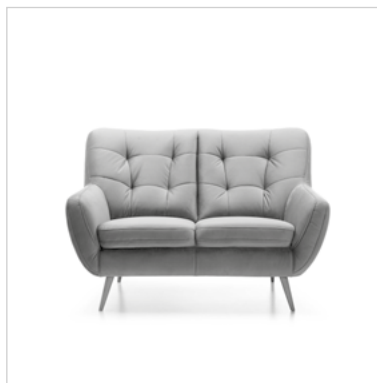

2

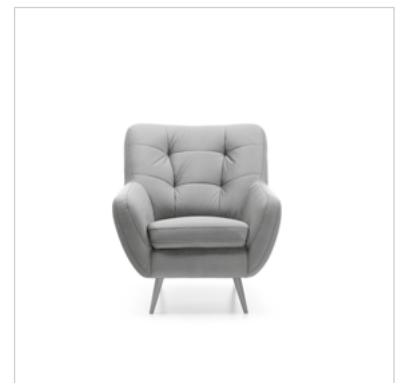

1

## dimensions

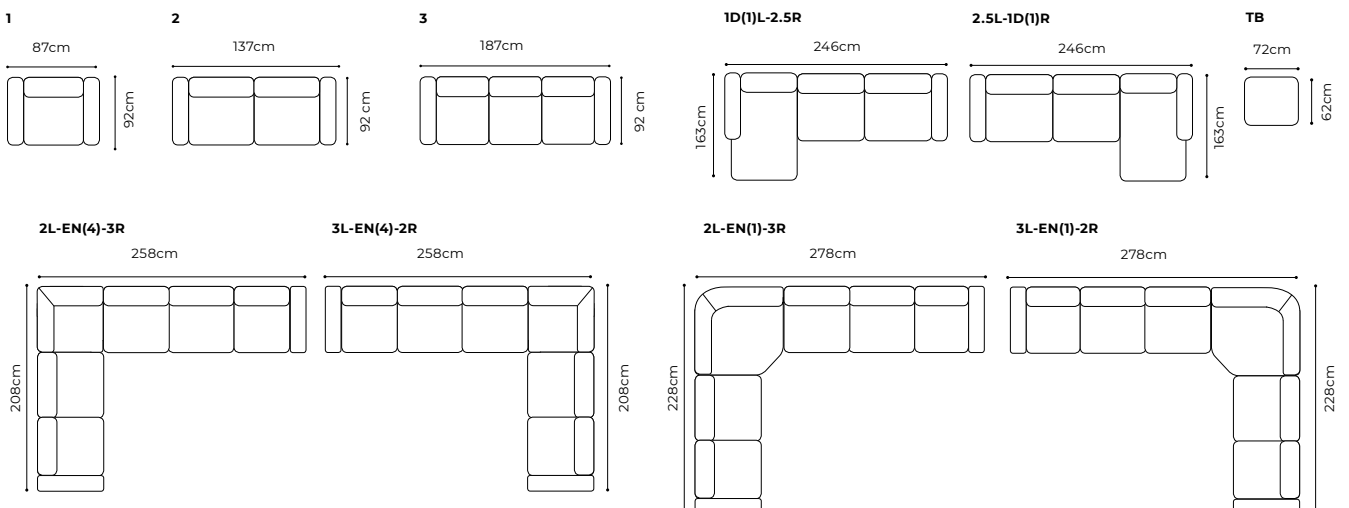



# LORIEN / BEO



The height of the furniture: **109 cm**  
 The height of the seat: **49 cm (Lorien)**  
 The height of the seat: **48 (Beo)**  
 The depth of the seat: **54 cm (Lorien)**  
 The depth of the seat: **56 cm (Beo)**  
 The height of the legs: **15 cm**  
 the width of the side: **16 cm (Lorien)**  
 the width of the side: **23 cm (Beo)**



Beo, 2(165) and ITV, fabric Piano 15 and Piano 10



ITV (relaxation function)

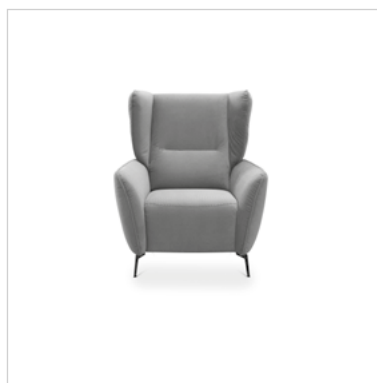

1

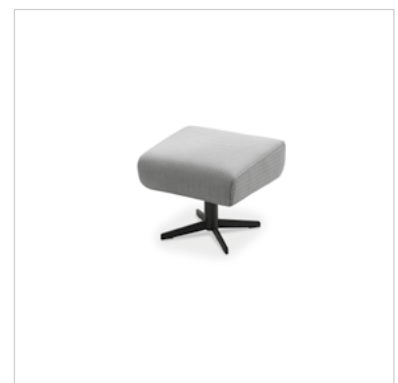

TB

## dimensions

### LORIEN

1

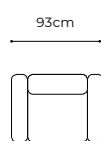

ITV

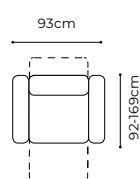

2

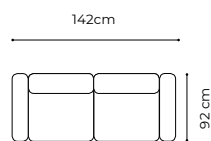

3

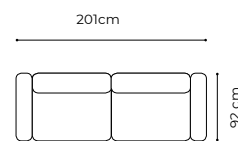

TB

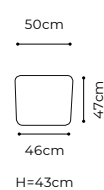

### BEO

1

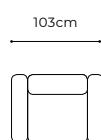

ITV

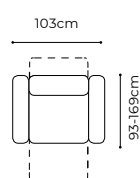

2(105)

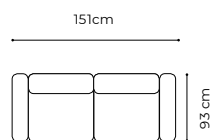

3(165)

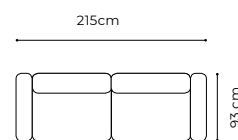

TB

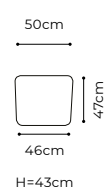





LORIEN  
p.  
73

# KELSO

The height of the furniture: **101 cm**  
 The height of the seat: **47 cm**  
 The depth of the seat: **53 cm**  
 The height of the legs: **15 cm**  
 The width of the side: **18 cm**



1, 3 and 2, fabric Bolshoi 16 stone, legs oak bianco



3

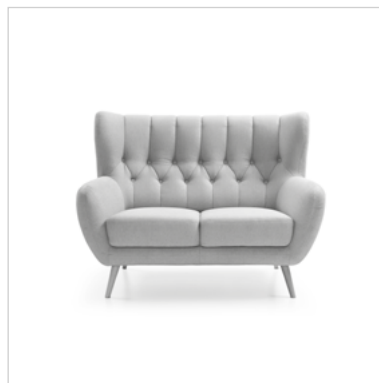

2

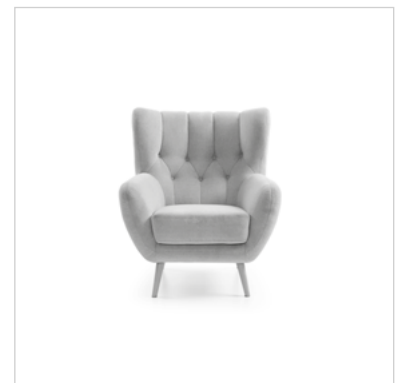

1

## dimensions

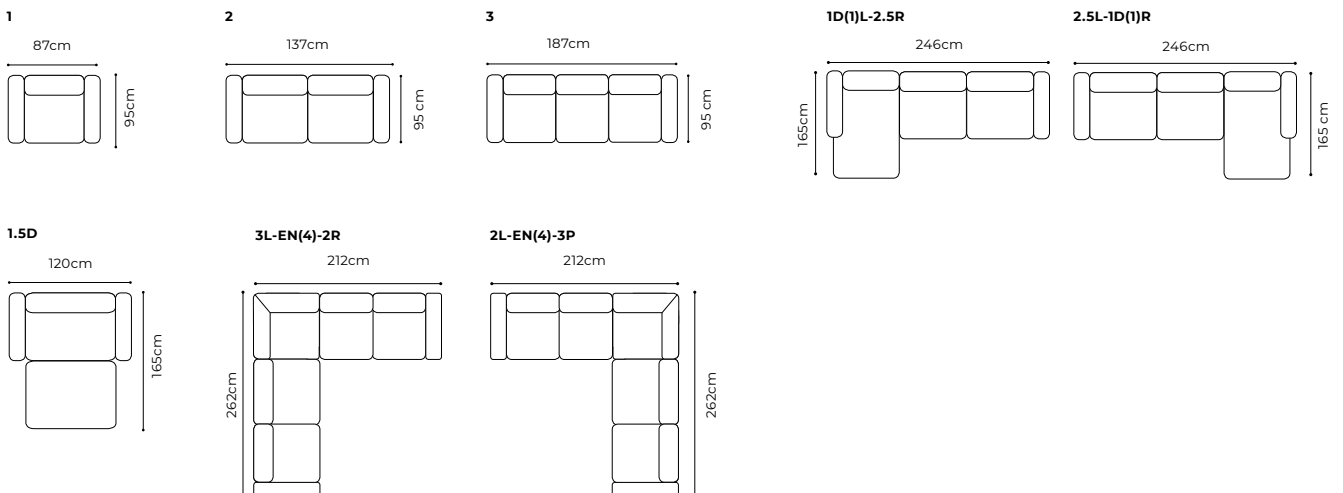

## VOSS

The height of the furniture: 101 cm  
 The height of the seat: 47 cm  
 The depth of the seat: 53 cm  
 The height of the legs: 18 cm  
 The width of the side: 19 cm



1(100)L-1D100(1)R, fabric Baron 24-Plum



3



1.5D

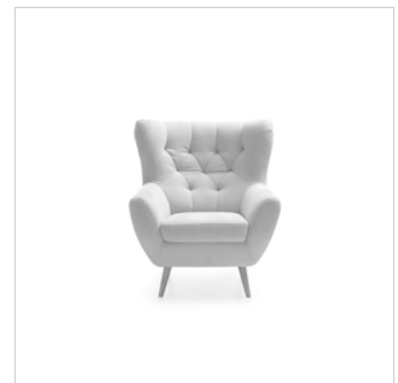

1

## dimensions

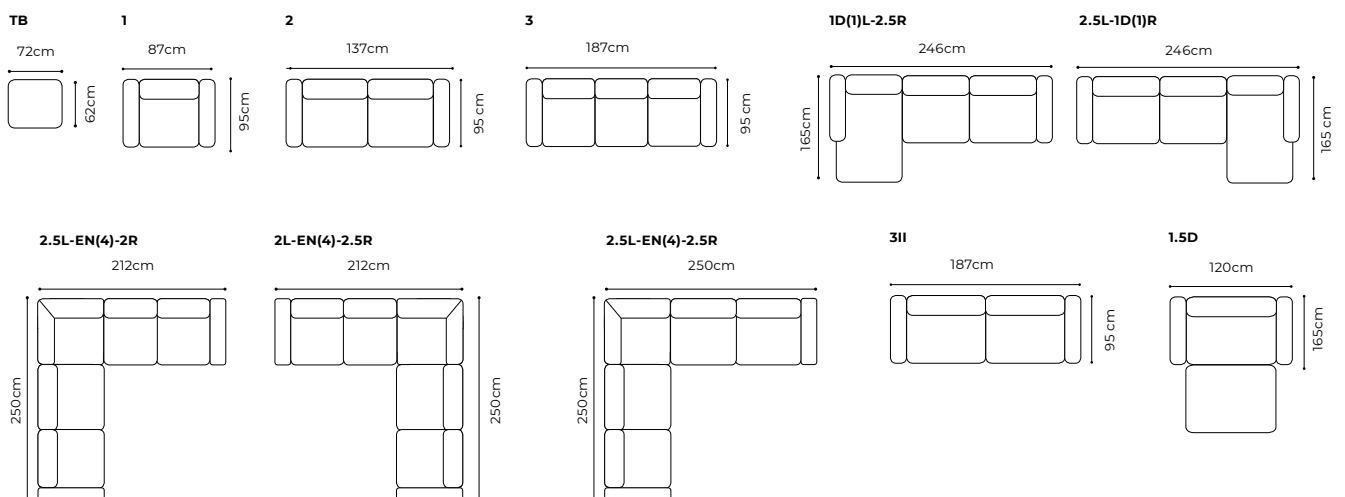





# BUSTO

The height of the furniture: **105 cm**  
 The height of the seat: **47 cm**  
 The depth of the seat: **57 cm**  
 The height of the legs: **4.5 cm**  
 The width of the side: **18 cm**



3F and ITVe, leather G-190



Sleeping function Sedalift



Relaxation function

## dimensions

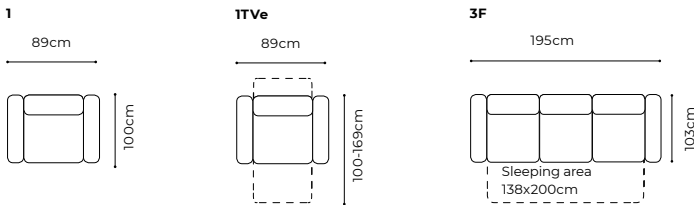



# CHOCO

The height of the furniture: **106 cm**  
 The height of the seat: **47 cm**  
 The depth of the seat: **55 cm**  
 The height of the legs: **4.5 cm**  
 The width of the side: **21 cm**



1TV and 3F, leather G-2170



Sleeping function Belgian frame



Relaxation function

## dimensions

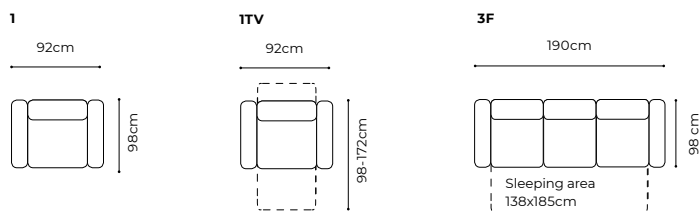

# TIVOLI

The height of the furniture: **87 cm** (unfolded)  
**108 cm** (folded)  
 The height of the seat: **47 cm**  
 The depth of the seat: **57 cm**  
 The width of the side: **17 cm**



BLC-ITVBB-BAR Ś-ITVBB-BRC, sofa BL-3TVBB-BR, leather G-220



Relaxation function



Liquor cabinet with a cubbyhole

## dimensions

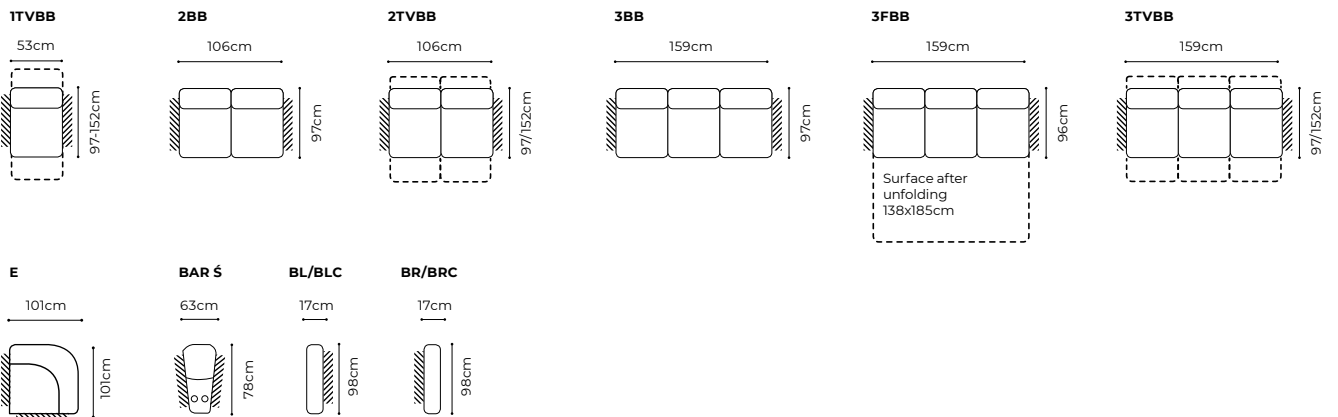

# MONDAY

The height of the furniture: **88 cm** (without headrest)  
**98 cm** (with optional headrest)  
 The height of the seat: **45 cm**  
 The depth of the seat: **57 cm**  
 The height of the legs: **12 cm**  
 The width of the side (1): **21 cm**  
 The width of the side: **25 cm**



1D70(8)L-2R+1xZAG, leather G-3885

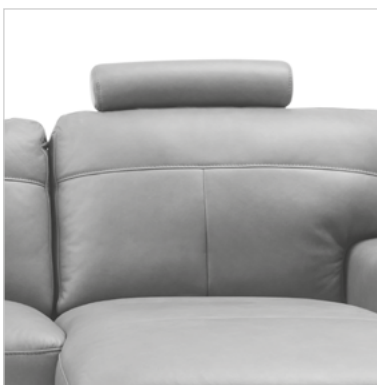

Optional headrest



Selection of leg type (black metal or wood)

## dimensions

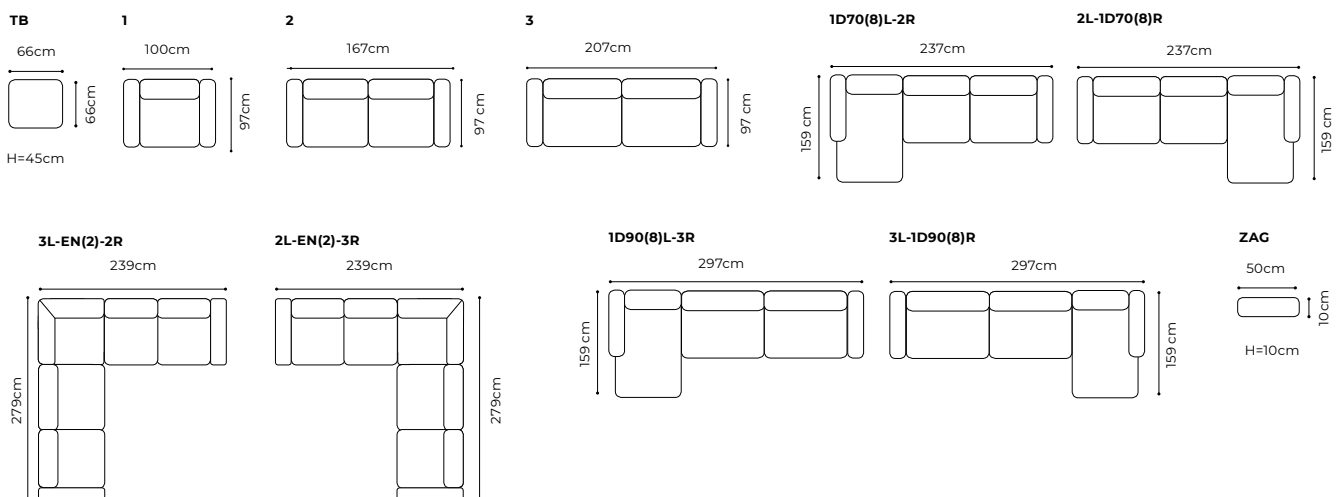





p. 83  
**MONDAY**

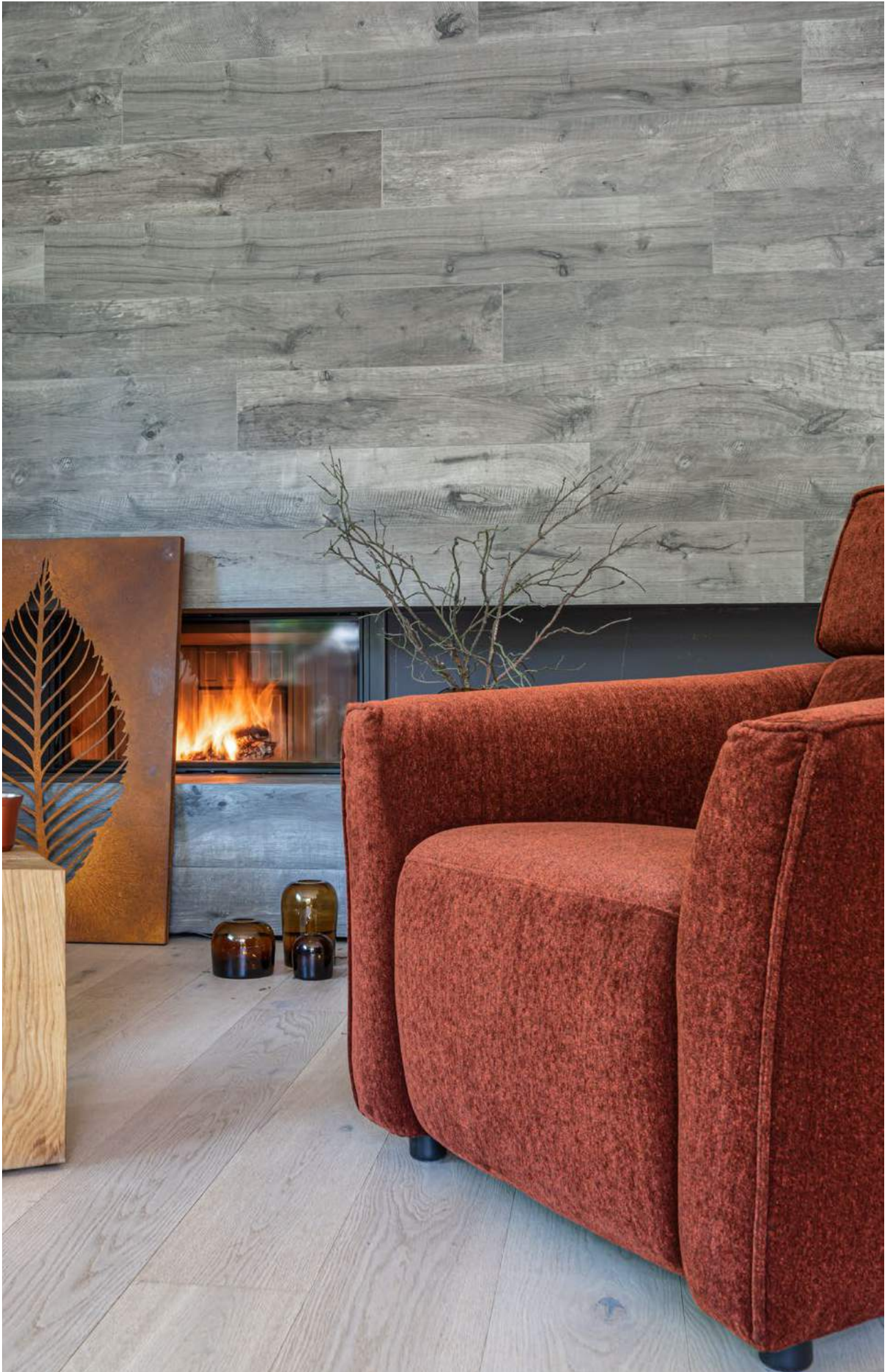

## Sleeping function - Italian frame



## Armchairs



Nola, 1



Olbia, 1

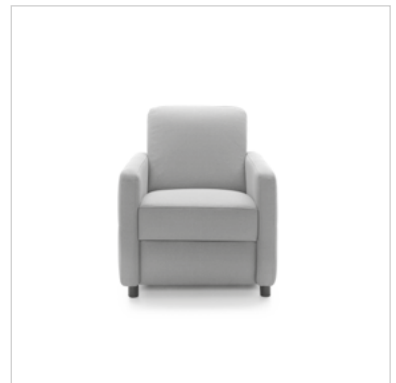

Ema, 1

Available also armchair Sora

## Additional functions

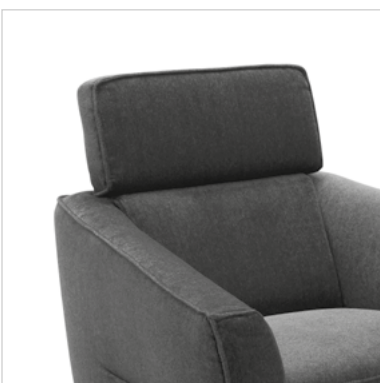

Movable headrest (Nola)



Bedding container (corner sofa: Ema, Olbia, Nola, Sora)

# NOLA



The height of the furniture: **77 cm** (armchair: 79 cm) (with the headrest folded)  
**96 cm** (armchair: 92 cm) (with the headrest unfolded)  
 The height of the seat: **48 cm** (armchair: 46 cm)  
 The depth of the seat: **64 cm** (armchair: 56 cm)  
 The height of the legs: **8 cm**  
 The height of the legs (1): **5 cm**  
 The width of the side: **21 cm**  
 The thickness of the mattress: **11 cm**



2(150)FF and 1, fabric Imperial 30

## dimensions

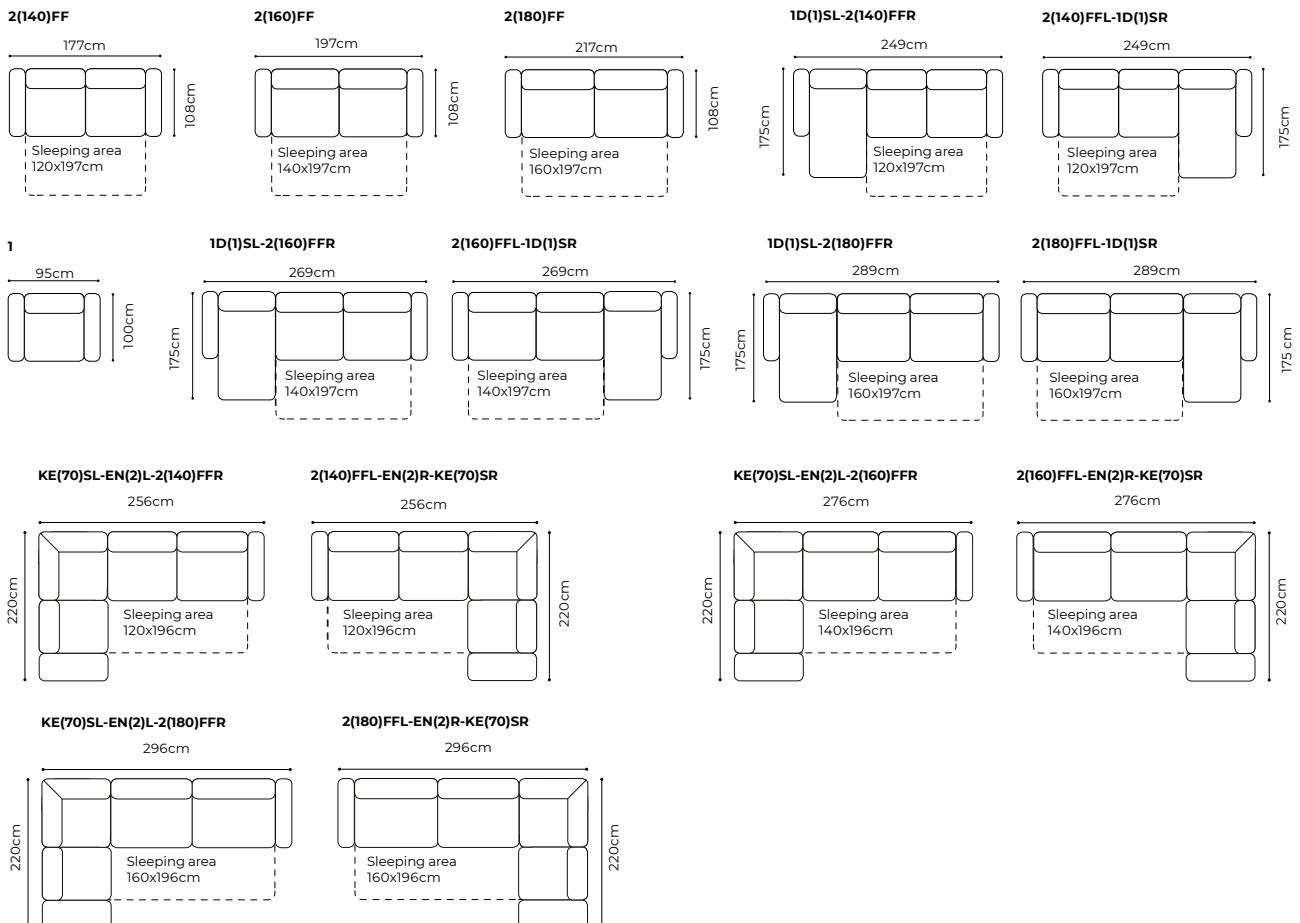



# OLBIA

The height of the furniture: **86 cm**  
 The height of the seat: **48 cm**  
 The depth of the seat: **60 cm**  
 The height of the legs: **8 cm**  
 The width of the side: **17 cm**  
 The thickness of the mattress: **11 cm**



2.5FF, fabric Napoli 16

## dimensions

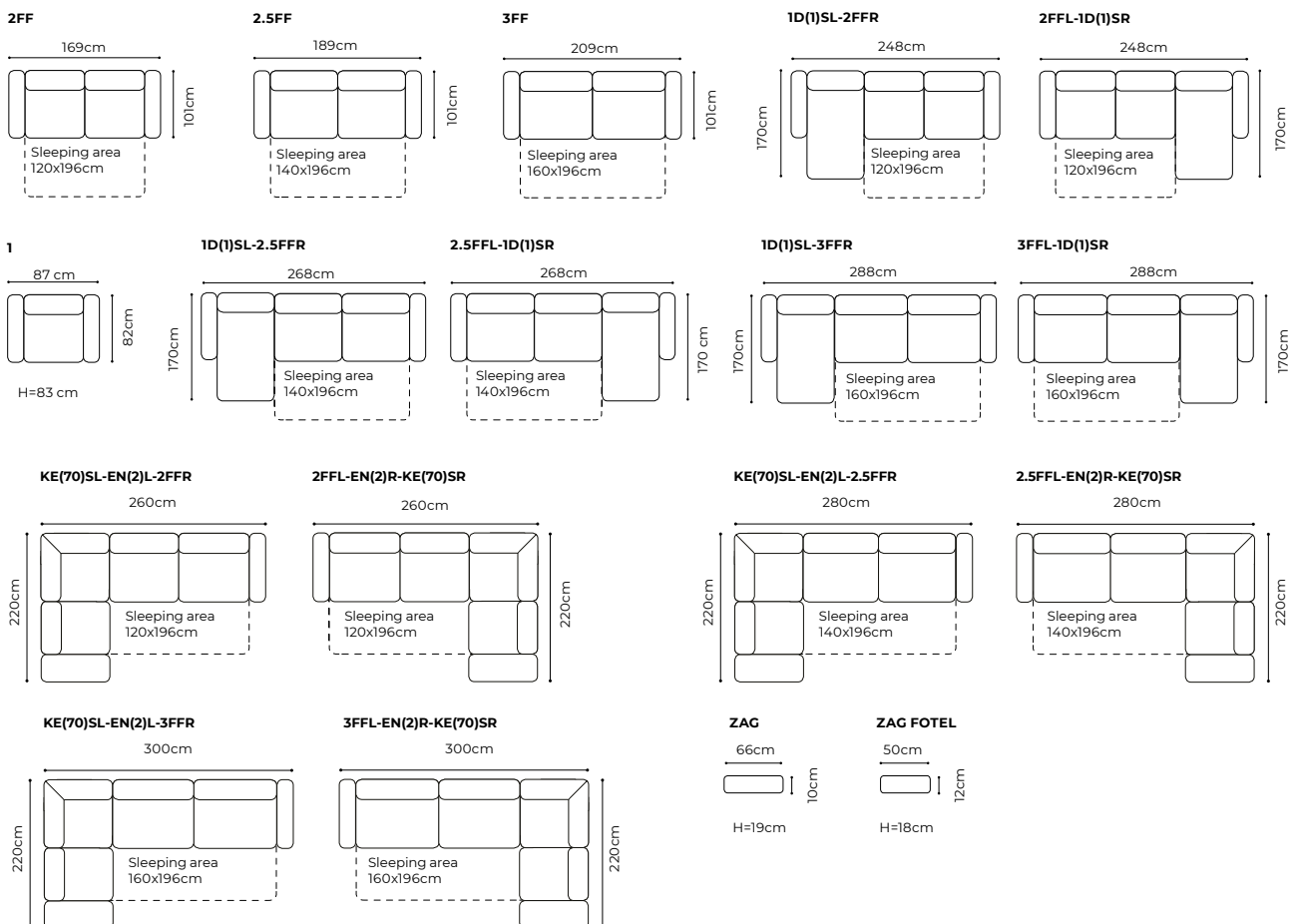

# EMA



The height of the furniture: **86 cm**  
 The height of the seat: **48 cm**  
 The height of the seat (1): **46 cm**  
 The depth of the seat: **60 cm**  
 The height of the legs: **8 cm**  
 The thickness of the mattress: **11 cm**  
 The width of the side: **11,5 cm**



2.5FF, fabric Torres 10

## dimensions

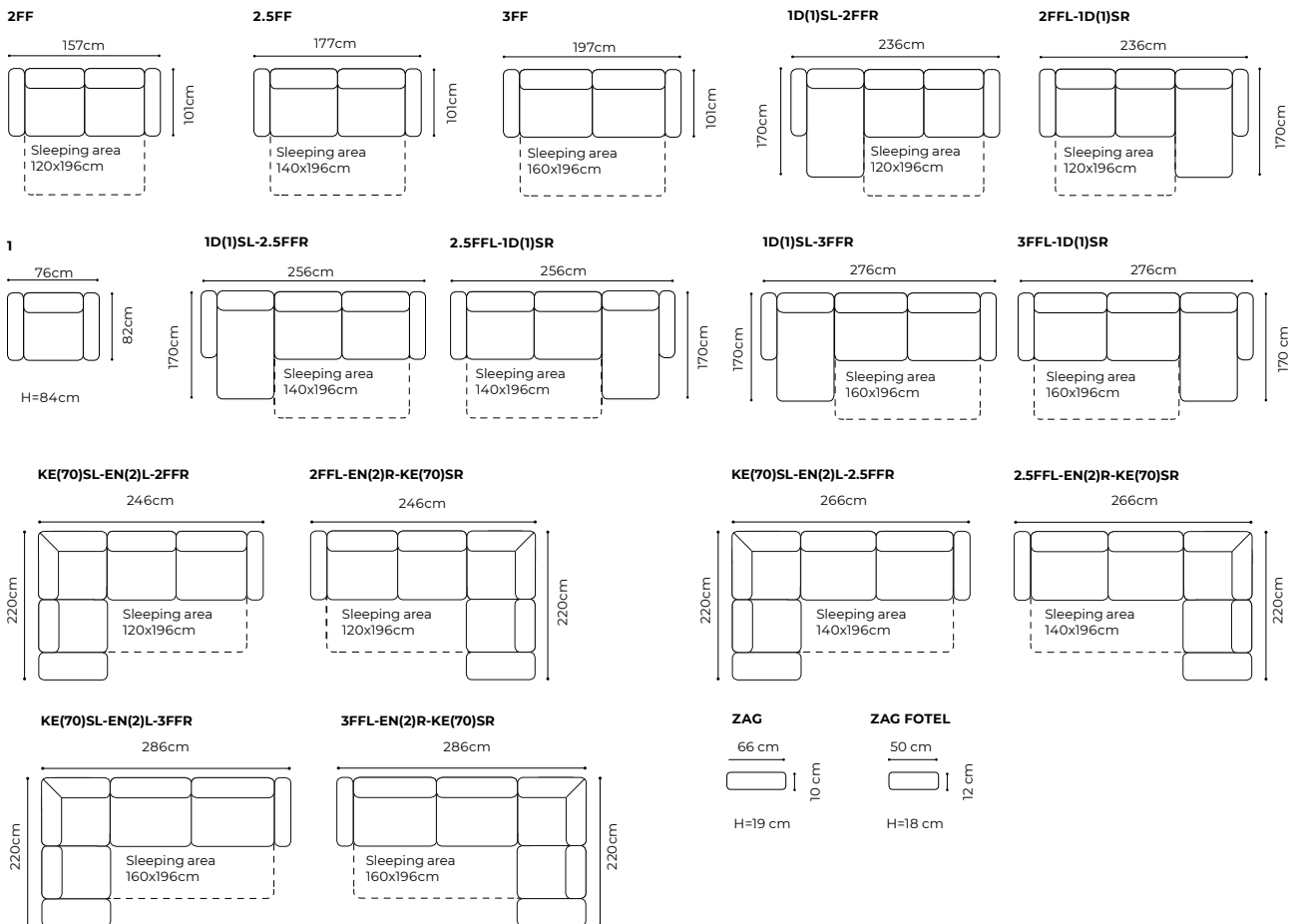

# SORA



The height of the furniture:	<b>86 cm</b>
The height of the seat:	<b>48 cm</b>
The height of the seat (1):	<b>46 cm</b>
The depth of the seat:	<b>60 cm</b>
The depth of the seat (1):	<b>52 cm</b>
The height of the legs:	<b>8 cm</b>
The height of legs (1):	<b>5 cm</b>
The thickness of the mattress:	<b>11 cm</b>
The width of the side (1):	<b>18 cm</b>
The width of the side:	<b>24 cm</b>



3FF, leather G-2110

## dimensions

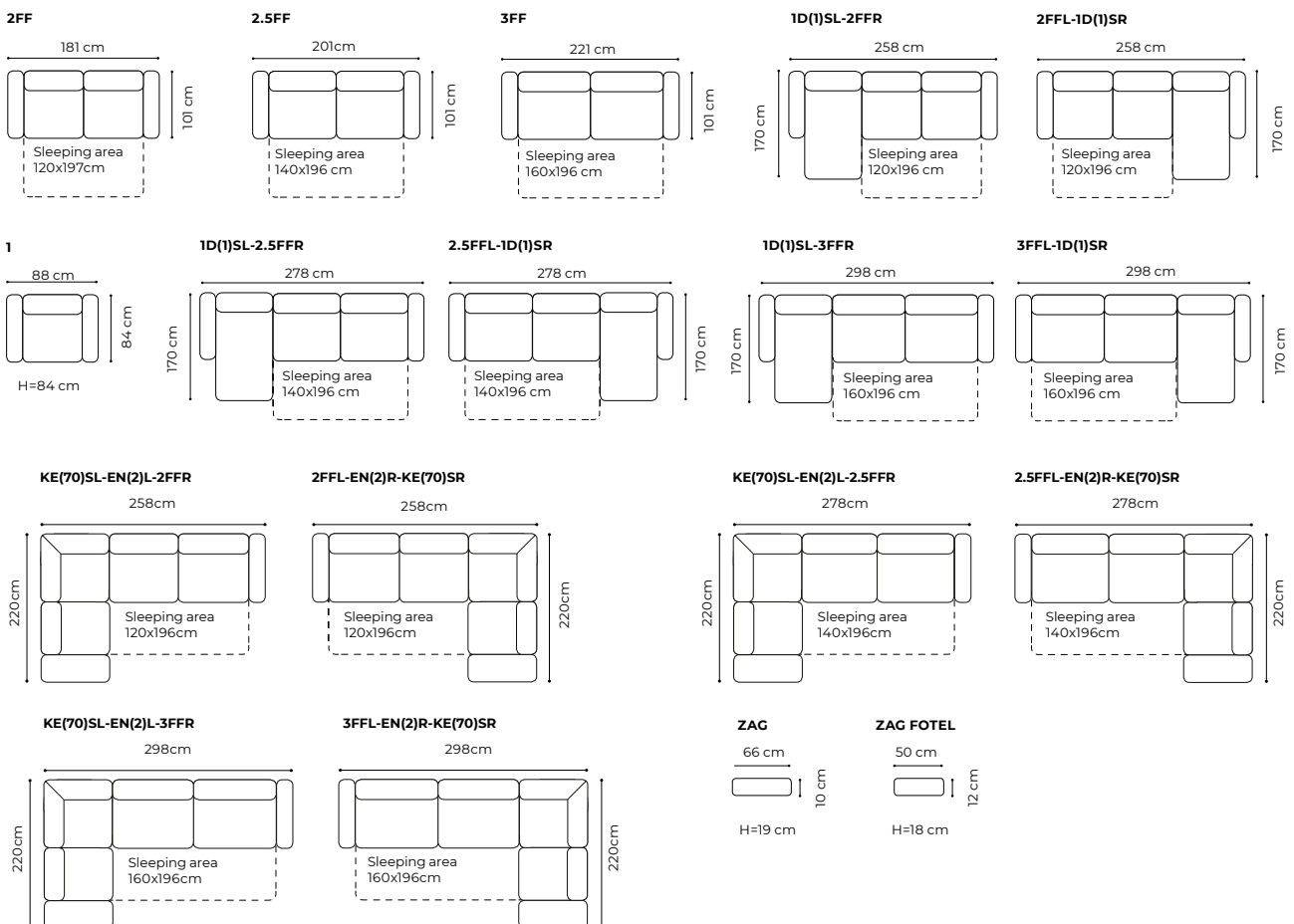

# ANCONA

The height of the furniture: **78 cm** (with the headrest folded)  
**95 cm** (with the headrest unfolded)  
 The height of the seat: **44 cm**  
 The depth of the seat: **58 cm**  
 The height of the legs: **10 cm**  
 The width of the side: **36 cm**



OTM(4)SL-2.5QFR, leather G-220



Sleeping function DELFIN



Bedding container



Movable armrest

## dimensions

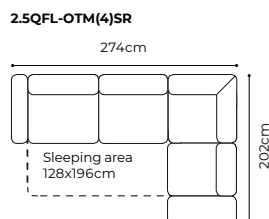
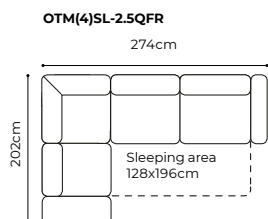

# ARLES / EDEN

The height of the furniture: **80 cm** (with the headrest folded)  
**94 cm** (with the headrest unfolded)  
 The thickness of the cushion: **12 cm**  
 The height of the seat: **45 cm**  
 The depth of the seat: **57 cm**  
 The height of the legs: **2,8 cm**  
 The width of the side: **14 cm**



Arles 2.5QFL-1D(2)SR +2xPODU, leather G-220



Sleeping function DELFIN



Bedding container



Eden 2.5QFL-1D(2)SR +2xPODU, leather G-220



Movable headrest

## dimensions

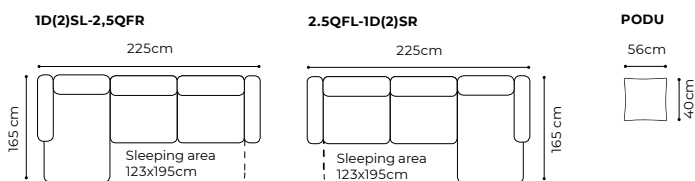

# ARNO / ANETO



The height of the furniture (1): **100 cm**  
 The height of the furniture (3F): **95 cm**  
 The height of the seat (1): **49 cm**  
 The height of the seat (3F): **47 cm**  
 The depth of the seat (1): **51 cm**  
 The depth of the seat (3F): **59 cm**  
 The height of the legs (1): **17 cm**  
 The height of the legs (3F): **15 cm**  
 The width of the side (1): **14 cm**  
 The width of the side (Arno): **17 cm**  
 The width of the side (Aneto): **14 cm**



Arno, 3F, TBS and 1, fabric Endo 7709, legs beech



Sleeping function C.S.T



Bedding container



Aneto, 3F, fabric Monolith 85, legs beech

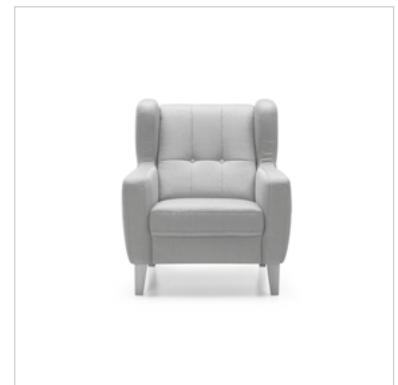

1

## dimensions

### ARNO

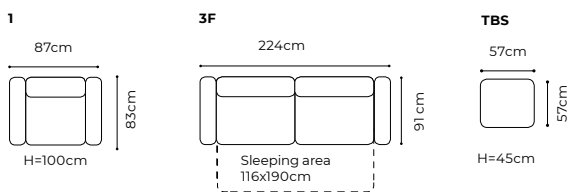

### ANETO

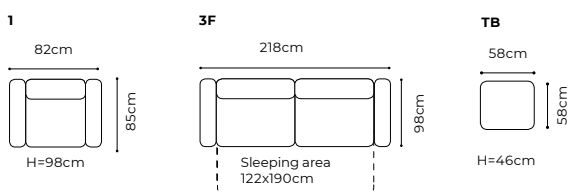

# BLOM

The height of the furniture: **103 cm**  
 The height of the seat: **48 cm**  
 The depth of the seat: **58 cm**  
 The height of the legs: **5 cm**  
 The width of the side: **19 cm**



2.5L-1D(1)R, fabric Pik 14



Sleeping function Leopard



Bedding container

## dimensions

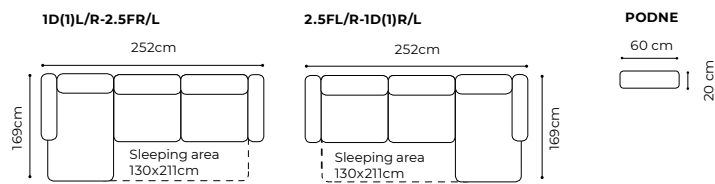

# BONO



The height of the furniture: **91 cm** (without headrest)  
**101 cm** (with optional headrest)  
 The height of the seat: **47 cm**  
 The depth of the seat: **52 cm**  
 The height of the legs: **4,5 cm**

\* A body available with its side in two widths:  
 standard side: 23 cm  
 narrow side: 13 cm  
 The catalogue dimensions are given with standard width 23 cm



3F and 1+ZAG, leather: color withdrawn from the offer



Sleeping function Trolley



Bedding container



Two side-breadths (standard: 23 cm, narrow: 13 cm)

## dimensions

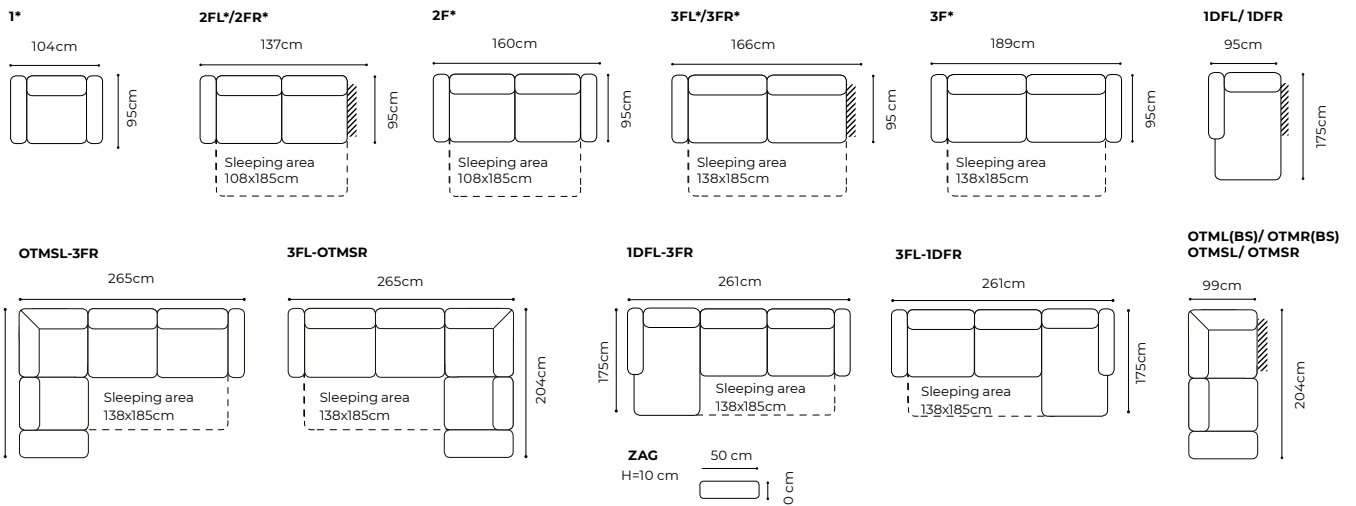



# ELIO / MALMO

The height of the furniture: **84 cm**  
 The height of the seat: **45 cm**  
 The depth of the seat: **57 cm**  
 The height of the legs: **10 cm**  
 The width of the side: **11 cm**



Sleeping function DELFIN



Bedding container



## dimensions

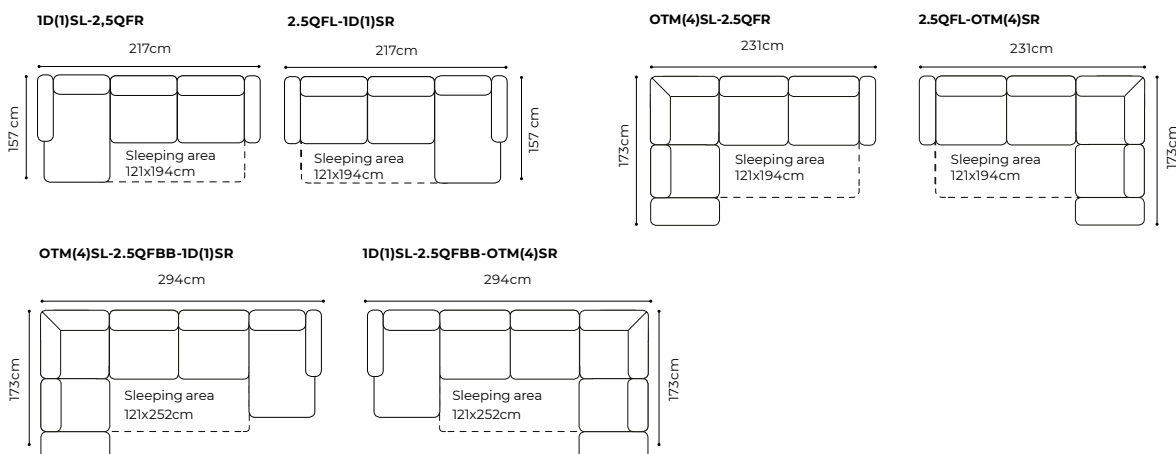

# FIORD



The height of the furniture: **87 cm**  
 The height of the seat: **49 cm**  
 The depth of the seat (1): **50 cm**  
 The depth of the seat (3F): **59 cm**  
 The height of the legs (1): **20 cm**  
 The height of the legs (3F+TBS): **15 cm**  
 The width of the side (1): **14 cm**  
 The width of the side (3F): **16 cm**



3F, 1 and TBS, leather G-190, legs oak with wax effect



Sleeping function C.S.T



Bedding container

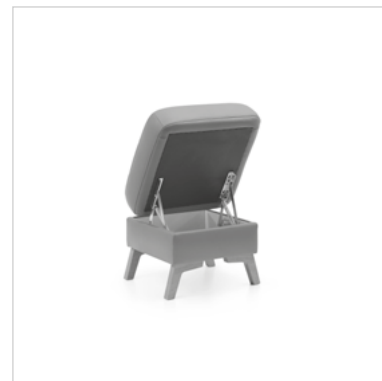

A pouffe with a box

## dimensions

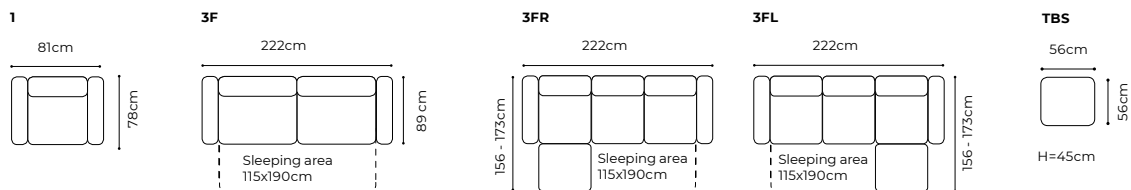

# HAPPY

The height of the furniture: **82 cm** (with the headrest folded)  
**98 cm** (with the headrest unfolded)  
 The height of the seat: **45 cm**  
 The depth of the seat: **56 cm**  
 The height of the legs: **8 cm**  
 The width of the side: **35 cm**



2.5QFL-OTM(4)SR, fabric Fancy 97, optional cushion - fabric Magu Jet 198



Sleeping function Delfin



Bedding container



Movable armrest

## dimensions

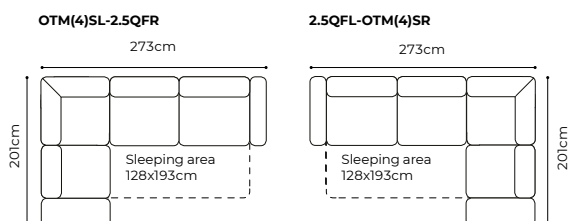

# LIDO

The height of the furniture: **91 cm** (without headrest)  
**102 cm** (with optional headrest)  
 The height of the seat: **47 cm**  
 The depth of the seat: **52 cm**  
 The height of the legs: **4,5 cm**  
 The width of the side: **38 cm**



OTML-3FR, leather G-100



Sleeping function Trolley



Bedding container

## dimensions

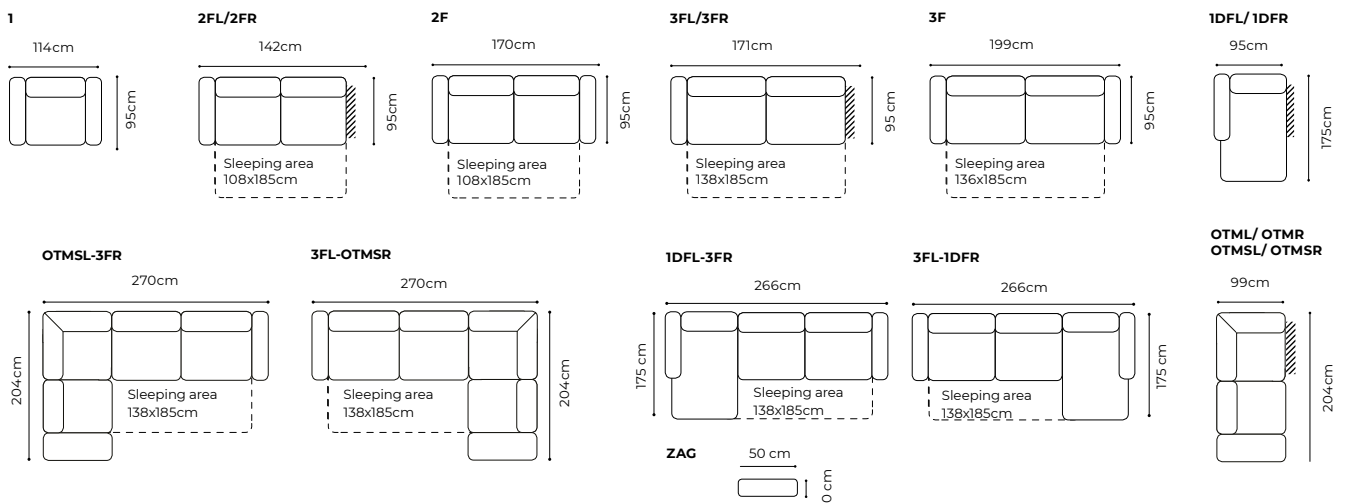

# LOTOS



The height of the furniture: **79 cm** (with the headrest folded)  
**92 cm** (with the headrest unfolded)  
 The height of the seat: **44 cm**  
 The depth of the seat: **58 cm**  
 The depth of the seat (1): **56 cm**  
 The height of the legs: **2,8 cm**  
 The width of the side: **24 cm**  
 The width of the side (1): **20 cm**



2.5QFL-ID(5)SR, leather G-220



Sleeping function Delfin



Bedding container

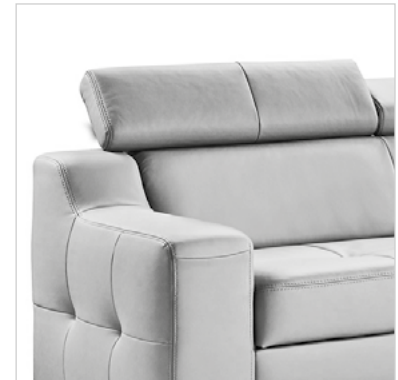

Movable headrest

## dimensions

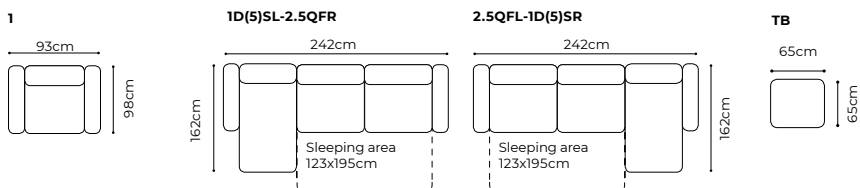

# MALPENSA

The height of the furniture: **81 cm** (without headrest)  
**95 cm** (with optional headrest)  
 The height of the seat: **45 cm**  
 The depth of the seat: **56 cm**  
 The height of the legs: **4,5 cm**  
 The width of the side: **37 cm**



OTMSL-2.5QFR, leather G-220



Sleeping function C.ST



Bedding container



Movable armrest

## dimensions

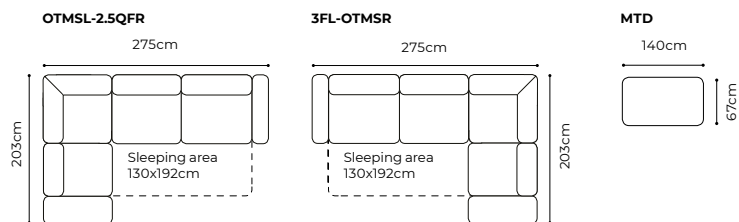

# MEMO

The height of the furniture: **82 cm** (with the headrest folded)  
**94 cm** (with the headrest unfolded)  
 The height of the seat: **47 cm**  
 The depth of the seat: **59 cm**  
 The height of the legs: **10 cm**  
 The width of the side: **27 cm**



2(140)QFL-OTM(4)SR, fabric Pegasus 27



Sleeping function Delfin



Bedding container



Movable headrest

## dimensions

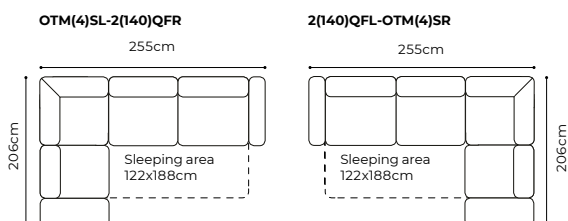

# MODO

The height of the furniture: **79 cm**  
 The height of the seat: **46 cm**  
 The depth of the seat: **63 cm**  
 The height of the legs: **5 cm**  
 The width of the side: **25 cm**



3F, fabric Power II



Sleeping function Leopard (sofa)



Sleeping function Leopard (corner sofa)



Bedding container

## dimensions

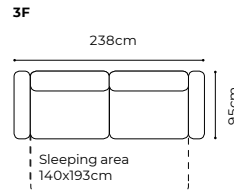
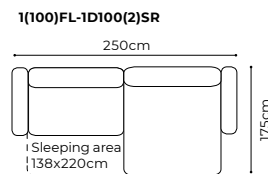
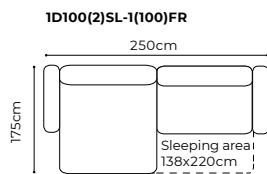



# NAPPA / BODO



The height of the seat **49 cm**  
 The depth of the seat (1): **50 cm**  
 The depth of the seat (3F): **59 cm**  
 The height of the furniture: **87 cm**  
 The height of the legs (3F): **15 cm**  
 The height of the legs (1): **20 cm**  
 The width of the side (1): **14 cm**  
 The width of the side (3F): **16 cm**



1 and 3F, fabric Endo 7713, optional cushions Kronos O4



Sleeping function C.S.T



Sleeping function C.S.T



Bodo, 3FR, fabric Pik 01, legs beech



Bedding container

## dimensions

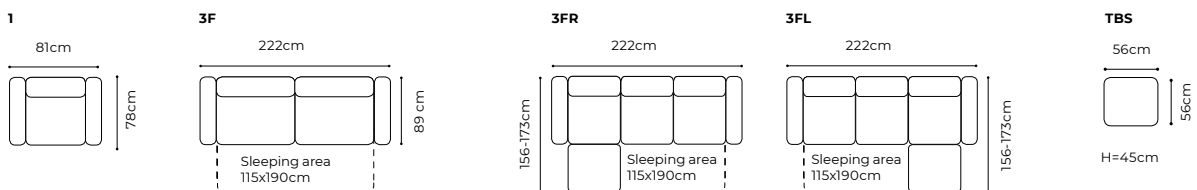

# NOVA

The height of the furniture: **87 cm**  
 The height of the seat: **49 cm**  
 The depth of the seat (3F): **59 cm**  
 The depth of the seat (1): **50 cm**  
 The height of the legs (3F): **15 cm**  
 The height of the legs (1): **20 cm**  
 The width of the side (3F): **17 cm**  
 The width of the side (1): **14 cm**

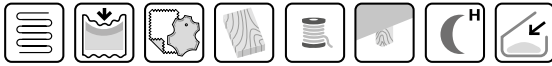

1 and 3F, fabric Riviera 38



Sleeping function C.S.T



Bedding container

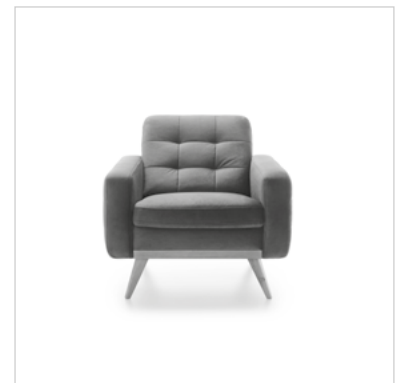

1

## dimensions

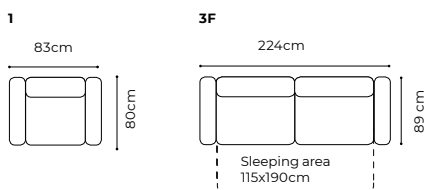

# OLAF

The height of the furniture: **87 cm**  
 The height of the seat: **49 cm**  
 The depth of the seat(1): **50 cm**  
 The depth of the seat(3F): **59 cm**  
 The height of the legs: **15 cm**  
 The width of the side: **10 cm**



1 and 3F, fabric Chester 15, wood colour - oak natural



Sleeping function C.S.T



1

## dimensions

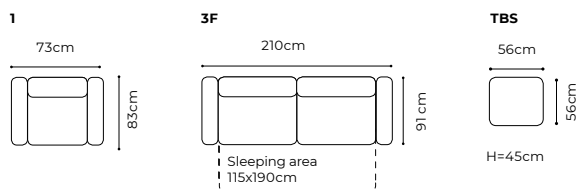

# ONLY

The height of the furniture: **96 cm** (without headrest)  
**112 cm** (with optional headrest)  
 The height of the seat: **47 cm**  
 The depth of the seat: **55 cm**  
 The height of the legs: **10 cm**  
 The width of the side: **17 cm**



2(140)QFL-OTMSR, fabric Salvador 15



Sleeping function Delfin



Bedding container



Optional headrest

## dimensions

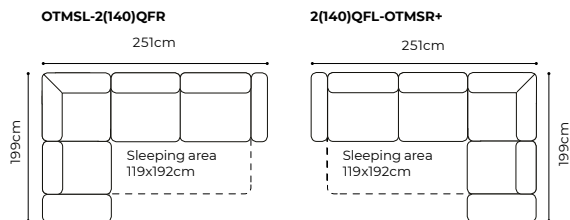

# SALERNO

The height of the furniture: **82 cm** (with the headrest folded)  
**95 cm** (with the headrest unfolded)  
 The height of the seat: **44 cm**  
 The depth of the seat: **56 cm**  
 The height of the legs: **4.5 cm**  
 The width of the side: **37 cm**



2.5QFL-OTMSR, leather G-220



Sleeping function Delfin



Bedding container



Movable armrest

## dimensions

2

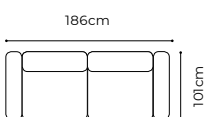

2.5F

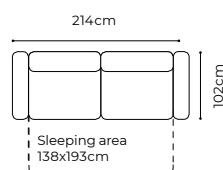

1DSL-2.5QFR

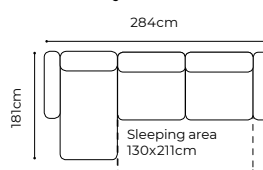

2.5QFL-1DSR

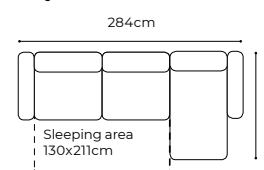

OTMSL-2.5QFR

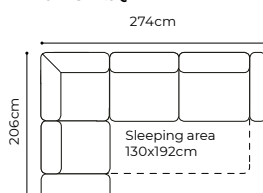

2.5QFR-OTMSR

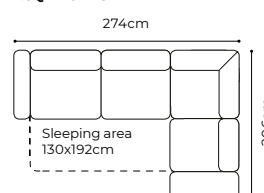

MTD

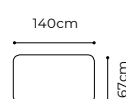

# SISTO

The height of the furniture: **81 cm** (with the headrest folded)  
**97 cm** (with the headrest unfolded)  
 The height of the seat: **47 cm**  
 The depth of the seat: **57 cm**  
 The height of the legs: **12 cm**  
 The width of the side: **19 cm**



2.5QFL-OTM(1)SR, leather G-180, optional cushion - fabric Celeste



Sleeping function DELFIN



Bedding container



Movable headrest

## dimensions

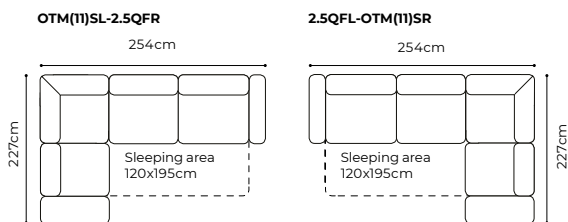

# SNAP

The height of the furniture: **84 cm**  
 The height of the seat: **47 cm**  
 The depth of the seat: **58 cm**  
 The height of the legs: **12 cm**  
 The width of the side: **14 cm**



3F, TRX , fabric Kronos 26



Sleeping function C.S.T



Bedding container



Raisable backrest in pouffe

## dimensions

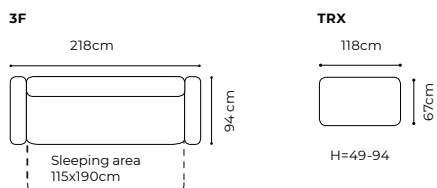

# TULA

The height of the furniture: **82 cm** (with the headrest folded)  
**98 cm** (with the headrest unfolded)  
 The height of the seat: **45 cm**  
 The depth of the seat: **56 cm**  
 The height of the legs: **8 cm**  
 The width of the side: **16 cm**



2.5QFL-OTM(4)SR , leather G-190



Sleeping function Delfin



Bedding container



Movable headrest

## dimensions

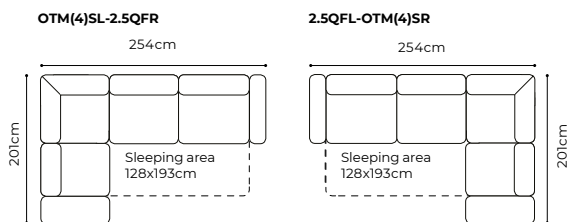



# VAPIANO

The height of the furniture: **81 cm** (with the headrest folded)  
**95 cm** (with the headrest unfolded)  
 The height of the seat: **45 cm**  
 The depth of the seat: **56 cm**  
 The height of the legs: **4,5 cm**  
 The width of the side: **35 cm**



2.5QFL-OTMSR, fabric Spectra 10



Sleeping function Delfin



Bedding container



Movable headrest

## dimensions

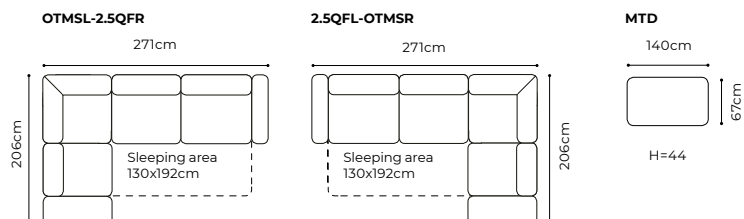

# VIGO

The height of the furniture (1): 85 cm  
 The height of the furniture (3F): 84 cm  
 The height of the seat: 45 cm  
 The depth of the seat (1): 51 cm  
 The depth of the seat (3F): 58 cm  
 The height of the legs: 12 cm  
 The width of the side: 15 cm



1, 3F, fabric Fancy 63



Sleeping function C.S.T



Bedding container

## dimensions

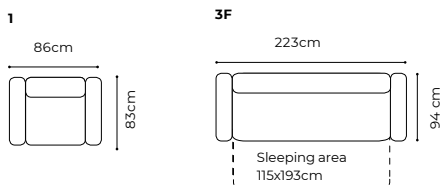

# YUKA



The height of the furniture (1): **87 cm**  
 The height of the furniture (3F): **91 cm**  
 The height of the seat: **42 cm**  
 The depth of the seat (1): **47 cm**  
 The depth of the seat (3F): **52 cm**  
 The height of the legs: **3 cm**  
 The width of the side (1): **16 cm**  
 The width of the side: **19 cm**  
 (other elements):



1, 3F and TM, leather G-4885



Sleeping function DL



1



TM

## dimensions

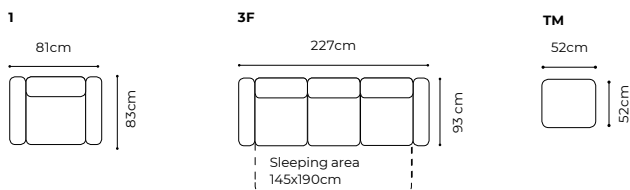

# BARISTA

The height of the furniture: **82 cm**  
 The height of the seat: **49 cm**  
 The depth of the seat: **47 cm**  
 The width of the side: **7 cm**  
 The height of the legs: **2,5 cm**

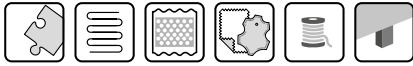

SET: OTM(197)L-(197)R, TB(100), leather G-3885

## dimensions

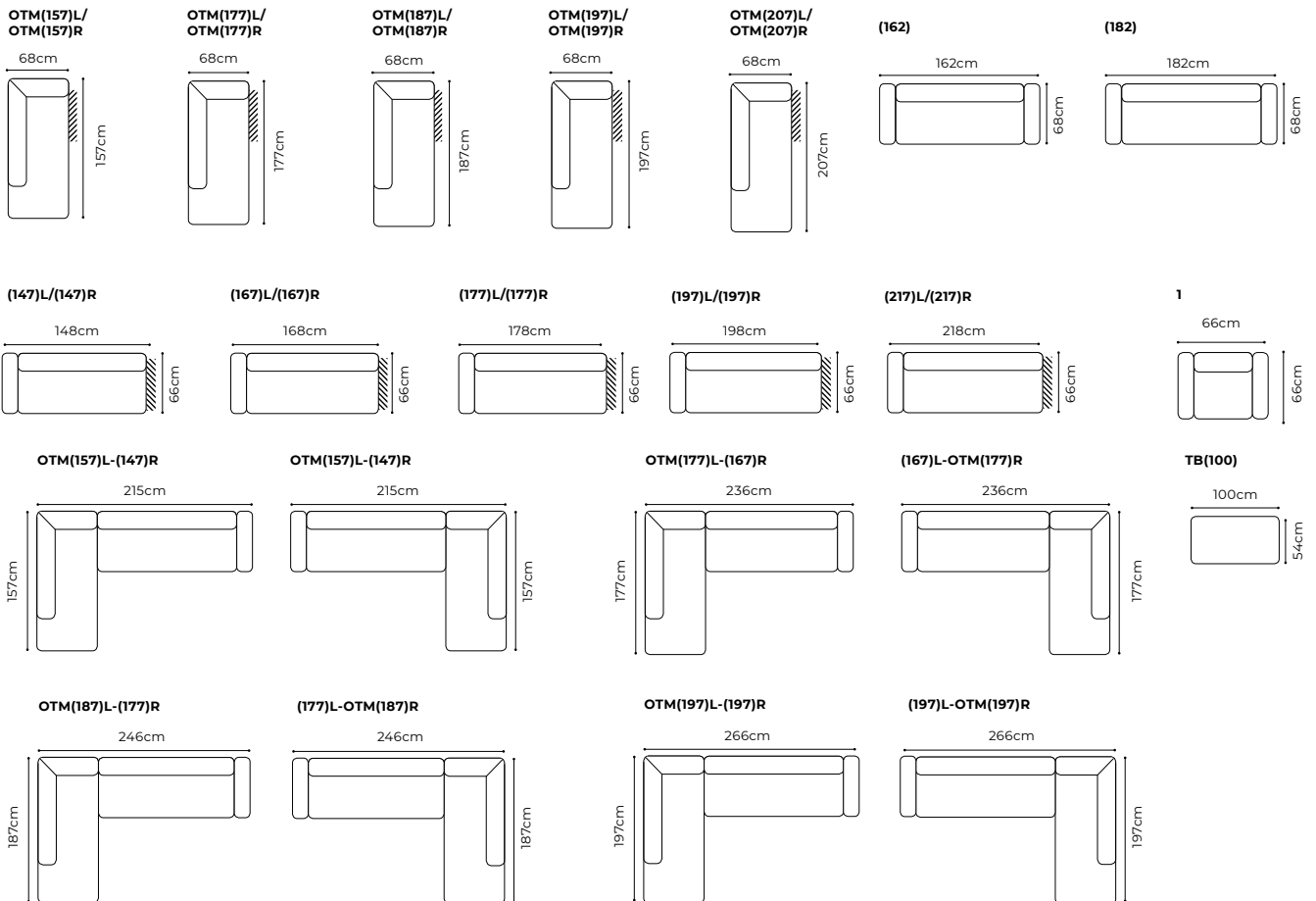

# CORTADO

The height of the furniture: **89 cm**  
 The height of the seat: **51 cm**  
 The depth of the seat: **46 cm**  
 The width of the side (1): **12 cm**  
 The width of the side: **16 cm**  
 (other elements):  
 The height of the legs: **2,5 cm**



SET: 1, leather G-2740; OTM(157)L-(170)R, leather G-2740 / G-2110

## dimensions

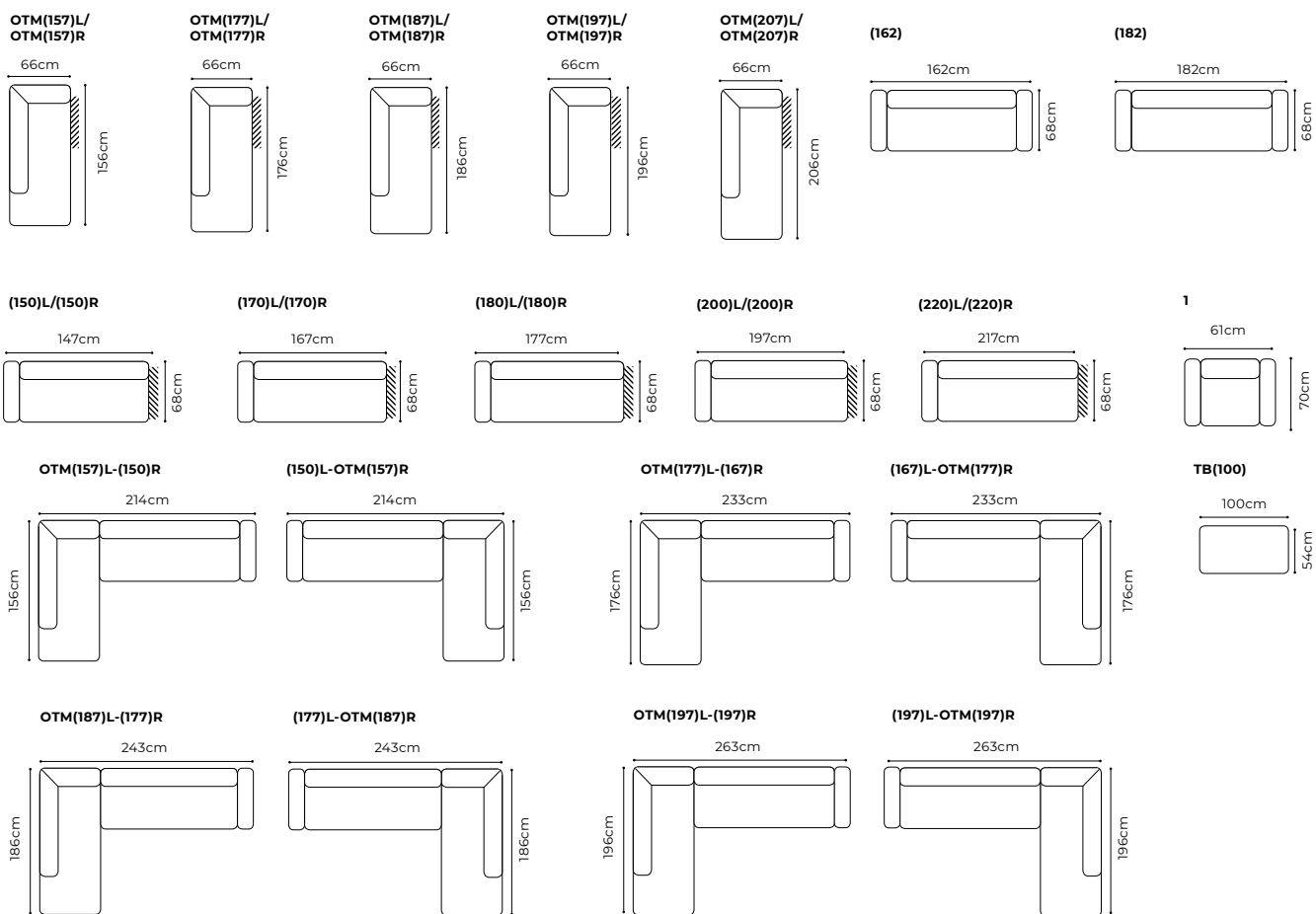



**Your  
Relax  
Space**

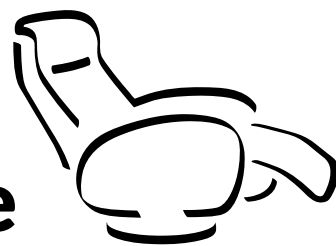

**ARMCHAIRS**

SMART  
MODERN  
CLASSIC  
ENJOY

# AROSA

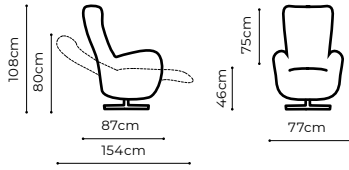

The depth of the seat: **55 cm**  
 The width of the side: **13 cm**



Selection of base type:



leather color withdrawn from the offer

# BERN

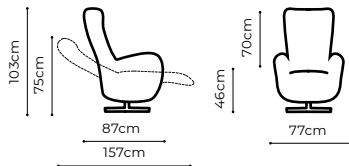

The depth of the seat: **55 cm**  
 The width of the side: **11 cm**



Selection of base type:





# RES

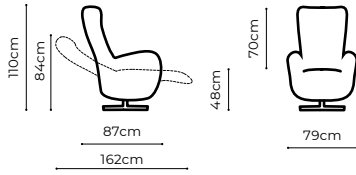

The depth of the seat: **55 cm**  
 The width of the seat: **52 cm**  
 The width of the side: **11 cm**



leather: color withdrawn from the offer

# FRIDA

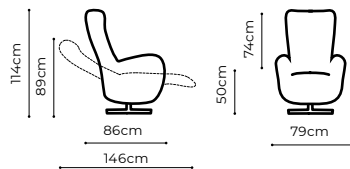

The depth of the seat: **55 cm**  
 The width of the side: **15 cm**



Selection of base type:



leather G-2960

# TOM

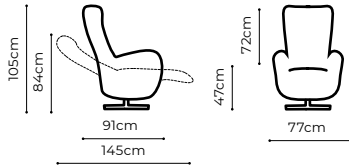

The depth of the seat: **56 cm**  
 The width of the side: **13 cm**



leather G-180

# PIKO

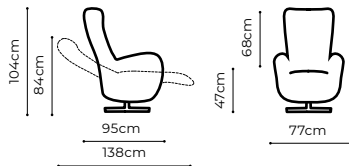

The depth of the seat: **57 cm**  
 The width of the side: **13 cm**



fabric Daytona 76

# INARI

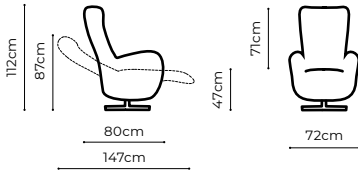

The depth of the seat: **48 cm**  
 The width of the side: **12 cm**



Selection of base type:



leather : color withdrawn from the offer

# KOMO

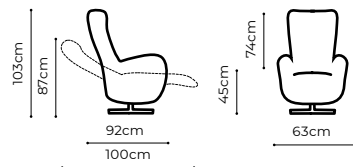

Selection of base type:



leather G-3785

# NEO

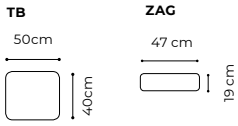
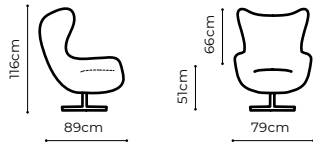

The depth of the seat: **55 cm**

Selection of base type:



Optional headrest



fabric Mystic 34

# NEO II

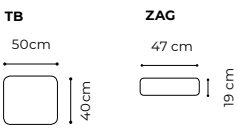
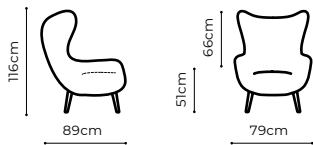

The depth of the seat: **55 cm**



Optional headrest



fabric Kronos 19

# ZING

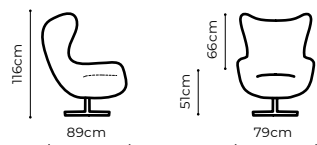

The depth of the seat: **55 cm**  
The height of the legs: **30 cm**

Selection of base type:



Optional headrest



fabric Nordic 116, Nordic 120

# ZING II

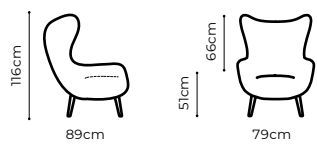

The depth of the seat: **55 cm**  
The height of the legs: **30 cm**

Optional headrest



leather Massif Graphite, fabric Sofia 15 with optional headrest

# DOT

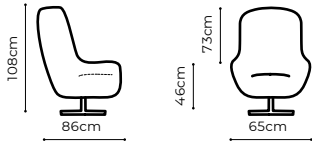

Selection of base type:



fabric Prestige 2765 and Prestige 2769

# DOT II

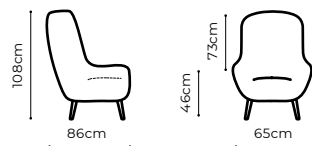

fabric Crown 15

# FIDO

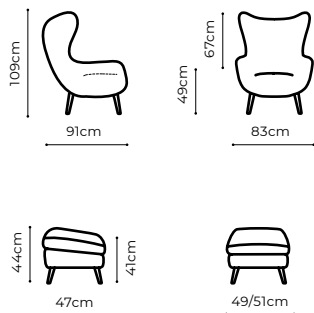
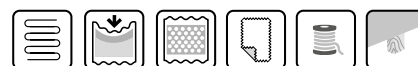

fabric Primo 52

# PRESTO

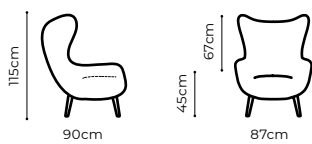

The depth of the seat: **48 cm**



Selection of base type:



fabric Crown Velvet 2

# BOSS

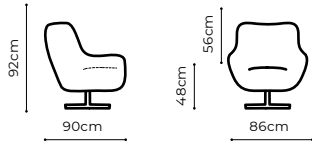

The depth of the seat: **51 cm**



Selection of base type:



leather: color withdrawn from the offer

# DIM

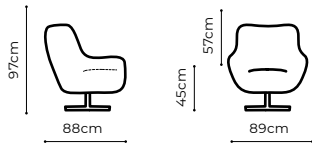

The depth of the seat: **54 cm**

Selection of base type:



fabric Sofia 08, leather color withdrawn from the offer



# SORIZO

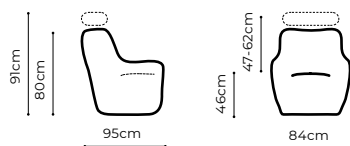

The depth of the seat: **53 cm**  
 The width of the side: **16 cm**



leather color withdrawn from the offer

# POUFFES



## TRX

depth: **68 cm**  
 width: **122 cm**  
 height: **46-97 cm**



## TM/TD

depth TM: **50 cm**  
 depth TD: **60 cm**  
 width TM: **50 cm**  
 width TD: **60 cm**  
 height TM/TD: **40 cm**



## DOMINO

depth: **46 cm**  
 width: **46 cm**  
 height: **45 cm**



# ORIO



The height of the seat: **42 cm**  
 The height of the furniture: **88 cm (unfolded)**  
**103 cm (folded)**



leather G-3150

# BIBBI

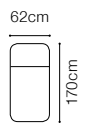

The height of the seat: **44 cm**  
 The height of the furniture: **80 cm**



leather G-3350

22 p. | NICEA



www.GalaCollezione.com

CHAISE LONGUE L, fabric Napoli 12

# CHAIRS



## XII

depth: 60 cm  
width: 52 cm  
height: 92 cm



## XIV

depth: 63 cm  
width: 66 cm  
height: 79 cm



## V

depth: 58 cm  
width: 46 cm  
height: 110 cm



## IX

depth: 44 cm  
width: 46 cm  
height: 96 cm



## VII

depth: 60 cm  
width: 59 cm  
height: 87 cm





# Leather and fabric

Gala Collezione furniture is offered in a **wide color palette**, made of **highest quality natural leather** and **high class fabrics**. Select the upholstery material which matches your needs and your home decor best in terms of texture and color.

**The natural leather** used to produce the Gala Collezione living room furniture is sourced from the best, proven tanneries. Each skin is carefully selected and cut by experienced cutters. You can be sure that the furniture you'll pick for your living room will have top-tier upholstery. Furniture leather is available in several dozen different hues - use the pattern books available in furniture salons to select the color that suits you most. This upholstery type will give your furniture a timeless character, stressing its unique design.

The Gala Collezione offer includes **textiles** with different properties and textures, including braiding, velvet, knitwear, flocked fabrics and chenille. These textiles differ from one another not only in terms of appearance, but also in terms of their technical parameters. All textiles are selected to guarantee the highest quality and long-term, problem-free use of the furniture item, and their color palette is so wide that every individual taste will be satisfied.

Remember that textile thickness does not always mean higher durability. Selecting the textile for your furniture, pay attention to its parameters, such as the presence of various fabric finishes which hinder the absorption of liquids, finishes which make water-based cleaning easier, resistance to tearing or stretching, snag-resistant structure, which makes it perfect even for households with animals.



### MADRAS leather

**Type:** closed face leather, with madras-type embossing

**Characteristics:**

- The face (top layer) has been embossed with a distinct fine regular pattern, which makes the natural characteristics of the leather less noticeable on its surface compared to smooth leather.
- It is coloured and protected with an impregnating varnish which increases resistance to abrasion and helps protect it from the effects of everyday use.
- It is one-tone leather, i.e. of uniform colour.

### PEGASO leather

**Type:** thick face leather, bovine, closed, with pegaso embossing

**Characteristics:**

- The face (top layer) has been embossed before the surface finish (prestampato), so that natural features such as bites, minor scars, veins or stretch marks are less visible on the surface.
- The increased thickness has a positive impact on the usability and quality and reduces susceptibility to creasing.
- It is coloured and protected with an impregnating varnish, which increases resistance to abrasion and external factors.
- It is one-tone leather, i.e. of uniform colour or two-tone (colour is uneven, shaded).

### FEDERICA leather

**Type:** bovine closed face leather, with federica embossing

**Characteristics:**

- The face (top layer) is gently embossed, making the pattern visible on the leather surface close to natural. As a result, small natural features such as scars, veins and a varied structure can be seen on the surface, which emphasises the natural origin of the raw material.
- The leather has a smooth and soft grip - it is soft and elastic, making it less susceptible to wrinkling during use.
- It is coloured in one-tone (uniform) or two-tone (the colour is uneven, shaded), two tones of the same colour from the same palette), protected with an impregnating varnish which increases resistance to abrasion and external factors, and is finished with a silicone-based impregnate.

### MASSIVE leather

**Type:** closed face leather, semianiline

**Characteristics:**

- The face (top layer) is embossed very gently so that its natural structure is preserved and small natural features such as scars or veins are visible on the surface.
- It is slightly processed in the finishing process to maintain its high degree of naturalness and to achieve a smooth and soft grip. Minor amounts of pigments and finishing agents are used - on the one hand, this allows to maintain the natural pattern on the surface and, on the other hand, to increase resistance to wear and tear and external factors.
- Due to the very delicate finishing process, the leather is pleasant and warm to the touch.
- This is one-tone leather, i.e. of uniform colour.

### GRANADA leather

**Type:** closed face leather, semianiline, from exotic cows.

**Characteristics:**

- The face (top layer) is embossed very gently so that its natural structure is preserved and small natural features such as scars or veins are visible on the surface.
- It is slightly processed in the finishing process to maintain its high degree of naturalness and to achieve a smooth and soft grip. Minor amounts of pigments and finishing agents are used - on the one hand, this allows to maintain the natural pattern on the surface and, on the other hand, to increase resistance to wear and tear and external factors.
- Due to the very delicate finishing process, the leather is pleasant and warm to the touch.
- It is a two-tone leather, i.e. with an uneven, shaded colour.

# 2D creator

[www.DesignYourSofa.online](http://www.DesignYourSofa.online)



If you want to configure a corner settee or sofa from one of selected modular systems on your own, use the 2D creator of Gala Collezione available at the address: [www.DesignYourSofa.online](http://www.DesignYourSofa.online).

A computer with access to the Internet and any web browser are enough. You do not have to know anything about designing or programming. The creator is very friendly and intuitive. It has been designed to guide you step by step through the process of configuring the furniture. In each stage, you can benefit from any kind of hints and explanations thanks to which you will precisely know what you should do at a particular moment and what effect you will get.

## Designing stages in 2D creator

### Step 1 - prepare dimensions of a room where you want to place the sofa

You start designing from drawing the shape of the room and placing obstructions situated in it. The obstructions are elements of equipment such as cabinet furniture, flower pots, potential pillars supporting ceiling, doors, partition walls and other.

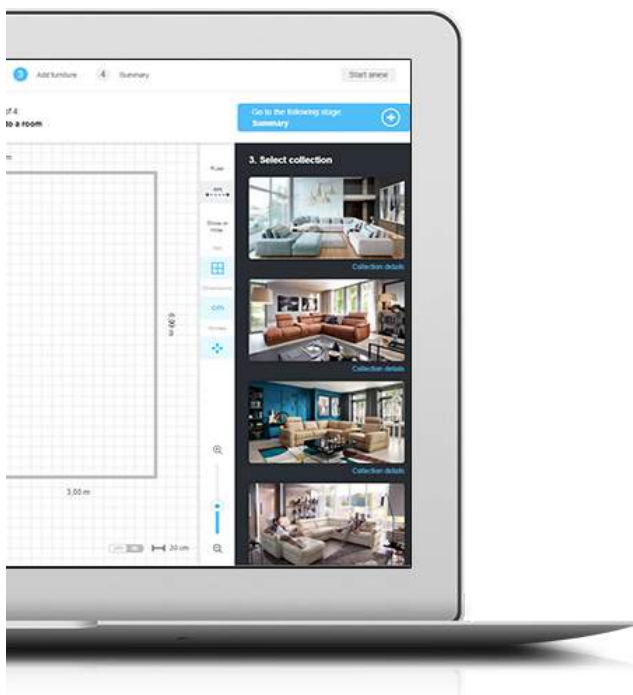

### Why is it important?

- thanks to this, you will know whether the designed sofa will fit into the room and whether it will be possible to maintain free passageway and easy access to windows, balcony, table in the dining part etc.,
- by determining dimensions of the room, you define the scale according to which the furniture will be designed - thanks to this, the system will choose the size of concrete block on its own so that it will be consistent with the dimensions

### Step 2 - choose the modular system which you like

At any time, you can read the description of a collection selected by you and get to know the functions which you can place in the designed furniture. If you have chosen the modular system, you can start configuring the sofa. From a list of available blocks, you select those you are interested in. The creator will prompt you on a current basis what blocks can be combined with each other to be able to easily benefit from these functions (e.g. unfolding the sleeping function or relaxing function).

### Step 3 - print the summary and buy the furniture

After completion of designing, you can print the summary containing the drawing of the configured sofa and specification of selected blocks. Take them with you to the furniture store where you want to buy the furniture. A seller will be able to accept your order at once, and you will focus entirely on selection of the colour and type of upholstery.



# For Interior Designers



If you're a professional or amateur designer or interior designer, visit our DESIGNER ZONE at [www.GalaCollezione.com](http://www.GalaCollezione.com), where you'll find all the materials and useful tools you'll need in your everyday work and to prepare unique and attractive interior designs for your clients.

**The DESIGNER ZONE** is an extensive, systematically updated section containing, among others:

- CAD libraries containing 3D models for the latest Gala Colezione furniture collections; the libraries were prepared in four most popular formats: DWG, OBJ, MAX and 3DS, packed into conveniently downloaded packets,
- libraries of colors and textures of natural leather, the most popular textiles and wood tints used in furniture legs, countertops and other wooden elements,

- electronic versions of current furniture catalogs offered by the Gala Collezione Furniture Factory.

All materials are available free of charge and without the need to log in. Simply download them at any time onto your computer, selecting the format of your choice. The materials are grouped in several separate tabs for your convenience.

[Download 3D models](#)



# Smart solutions

## Sleeping functions types:



### Type A - DELFIN

Slide the cart from under the furniture item and slightly lift the foam mattress to level up the sleeping surface with the seating area.



### Type B - LEOPARD

Slightly lift the front part of the furniture item, then pull it towards you to unfold the seating area. The sleeping part will lift automatically.



### Type C - TROLLEY

Slide the cart from under the furniture item, pulling it towards you. Then rotate the seating area to level up the sleeping surface.



### Type D - SEDALIFT

Pull out the cart, and then unfold the mattress and the folded foot that supports the structure. A thicker mattress provides an extra comfort.



### Type E - BELGIAN FRAME

Resembles a cot in terms of structure, and unfolds like one. The seating part must be removed for the bed to unfold.



### Type F - ITALIAN FRAME

Pull the handle on the top of the backrest and unfold the frame which supports the mattress.



### Type G - DL

Slide the seating part towards you, and then rest your back to obtain different sleeping positions.



### Type H - C.S.T.

This sleeping function unfolds like a traditional sofa bed.

## Other functions:



### Relaxation function

This function allows you to adjust the tilt angle of the back- and footrest, so that you can rest comfortably in any position, from sitting upright to semi-reclined. The relaxation function can be controlled manually (relying on the user's own strength) or by means of electrical sensors, discreetly placed between the seat and the side of the furniture item. The electric relaxation function can be powered by a battery or an electric mains socket.



### Headrests

Thanks to the gradual adjustment of their tilt angle, our headrests provide comfortable support for your neck when reading, watching TV or relaxing. Optionally, the mobile headrests can be moved to any other place.



### Liquor cabinet

With cubbyholes opened from the top, drawers sliding out from the front, wooden countertop, which you can use as a coffee table, with countertop upholstered with leather or fabric, triangular or rectangular, with cup holders – there are many types of liquor cabinets which offer plenty of opportunities.



### Movable seat

Electrically operated movable seat guarantees the possibility of increasing its depth. The slide-out seat can be successfully used for resting in a sitting and a semi-reclined position.

# Explanation of pictograms

 modular system	 movable armrests with Safe Mechanism system	 liquor cabinet with a box
 sleeping function type A (DELFIN)	 movable seat, controlled by electrical sensors	 selection of upholstery types (leather or fabric)
 sleeping function type B (LEOPARD)	 movable backrests	 selection of fabric colour
 sleeping function type C (TROLLEY)	 movable brackets with Automatic Return System	 possible combination of at least two colours (leather with leather, leather with fabric or fabric with fabric)
 sleeping function type D (SEDALIFT)	 movable headrests with adjustable tilt angle which form an integral part of the furniture	 selection of thread colour
 sleeping function type E (BELGIAN)	 movable headrests with Automatic Return System	 decorative wood elements (shelves, countertops)
 sleeping function type F (ITALIAN FRAME)	 optional removable headrests that can be installed on any backrest	 swivel armchair
 sleeping function type G (DL)	 backrest / corner elements with loose cushions	 possible selection of base / legs type
 sleeping function type H (C.S.T.)	 a bedding container	 wooden legs (possible selection of wood colour)
 manually unfolded relaxation function (available only in leather upholstery)	 top elastic filling	 chrome legs
 electrically unfolded relaxation function – the armchair has to be connected with a cable to an electric mains socket	 high resilience foam	 metal legs
 electrically unfolded relaxation function – the armchair is supplied from a battery – no need to have a mains socket	 polyurethane foam	 plastic legs
 electrically unfolded function RELAX PLUS - the armchair has to be connected with a cable to an electric mains socket	 silicone filling in the backrest and / or headrest	 wheels
 electrically unfolded function RELAX PLUS - the armchair is supplied from a battery - no need to have a mains socket	 wave springs	 platform legs
 movable armrests with adjustable tilt angle	 Bonell springs	 required distance from the wall

## Notices:

Actual size of furniture may differ from the size declared in the Manufacturer's commercial offer. The permissible deviation of dimensions from the declared ones is:

- +/- 2 cm if the declared dimension (width, depth or height of the furniture in ready-to-use configuration) is less than or equal to 150 cm,
- +/- 2,5 cm if the declared dimension (width, depth or height of the furniture in ready-to-use configuration) is greater than 150 cm,

- Freestanding items and armchairs with relaxation function available only in leather upholstery.
- Relax upholstery do not fulfill a function of sleeping beds, due to the abovementioned the sleeping function in most of the models should be used rather occasionally.
- The audio panel has been withdrawn from the offer. Although it occurs on selected photos, further sale is no more available.

# Кожи и ткани

Мебель Gala Collezione доступна в широкой цветовой гамме самых высококачественных натуральных кож и тканей. Вы можете выбрать такой обивочный материал, который больше всего подходит для обустройства Вашей гостиной, как в плане фактуры, так и цвета.

Все виды натуральной кожи, используемые в производстве мягкой мебели Gala Collezione, доставлены из лучших, проверенных кожевенных заводов. Каждый отрез кожи выбран и разрезан опытными кройщиками, поэтому Вы можете быть уверены, что мебель для гостиной, которую Вы выбираете, имеет высококачественную обивку. Кожа для мебели доступна в нескольких десятках разных оттенков – на основании образцов, предлагаемых в мебельных салонах вы можете выбрать такой цвет, который Вам больше всего нравится. Этот вид обивки придает мебели элегантность, подчеркивая её дизайн.

„В предложении Gala Collezione есть ткани с различными свойствами и фактурами, в том числе плетеные, вельветовые, трикотажные, флокированные и шенильные. Эти ткани отличаются между собой не только внешним видом, но и техническими параметрами. Все ткани в ассортименте подобраны так, чтобы обеспечить высокое качество и гарантировать длительную, беспроблемную эксплуатацию мебели, а их цветовая гамма настолько широка, что удовлетворит вкусы даже самых требовательных клиентов.

Помните, что не всегда чем толще ткань, тем она долговечнее. Подбирая ткань для мебели, обратите внимание на разные параметры, такие как, например, наличие апретур, ухудшающих впитывание жидкости, апретур, облегчающих лёгкую очистку водой, устойчивость к истиранию (которую определяет тест Мартиндейла), прочность ткани на пилинг и скатывание, прочность окраски, прочность на разрыв или растяжение, наличие структуры, предотвращающей затягивание нитей, благодаря чему обивка подходит также для людей, имеющих домашних животных.



## КОЖА MADRAS

**Вид:** кожа лицевая, закрытая, с формовкой типа madras.

### Характеристика:

- Лицо (верхний слой) с формовкой в виде мелкого узора, что делает природные черты кожи менее заметными на её поверхности по сравнению с гладкими сортами кожи.
- Окрашена и защищена лаком для пропитки, повышающим стойкость к истиранию и помогающим хранить кожу от последствий ежедневной эксплуатации.
- Это одноцветная кожа

## КОЖА PEGASO

**Вид:** толстая лицевая, закрытая, бычья кожа с формовкой типа pegaso.

### Характеристика:

- Лицо (верхний слой) с формовкой узора, сделанной перед верхней отделкой (prestampato), благодаря чему природные черты кожи, такие как, например, укусы, мелкие рубцы, сухожилия и растяжки менее заметны.
- Повышенная толщина положительно влияет на эксплуатационные характеристики и повышает стойкость к появлению складок
- Окрашена краской и защищена лаком для пропитки, повышающим стойкость к истиранию и помогающим хранить кожу от последствий ежедневной эксплуатации.
- Это одноцветная кожа или двухцветная (цвет неоднородный, оттененный)

## КОЖА FEDERICA

**Вид:** кожа лицевая, закрытая, бычья с формовкой типа federica.

### Характеристика:

- Лицо (верхний слой) с легкой формовкой, благодаря чему узор видный на поверхности кожи близок натуральному. В связи с этим можно на ней увидеть лёгкие натуральные признаки, такие как, например, жилки, дифференцированную текстуру, что подчёркивает природное происхождение сырьевого материала.
- Кожа мягкая и эластичная, благодаря чему она менее подвержена появлению морщин и складок во время эксплуатации.
- Окрашена одноцветной краской или двухцветной (цвет неоднородный, оттененный, два тона того же цвета) и защищена лаком для пропитки, повышающим стойкость к истиранию и помогающим хранить кожу от последствий ежедневной эксплуатации и влияния внешних факторов, Кожа также после поверхностной отделки – покрытая лаком на основании силикона.

## КОЖА MASSIVE

**Вид:** кожа лицевая, закрытая, полуаналиновая.

### Характеристика:

- Лицо (верхний слой) с очень легкой формовкой, благодаря чему её фактура сохранена и на её поверхности отлично видны мелкие натуральные черты, такие как, например рубцы и жилки.
- Во время отделки этот вид кожи подвергается небольшой обработке, что позволяет сохранить как можно больший уровень натуральности, а также получить гладкость и эластичность. Используются небольшие количества красок и отделочных материалов - с одной стороны это позволяет на сохранение натурального узора на поверхности кожи, а с другой стороны, повышает уровень охраны кожи от последствий ежедневной эксплуатации и внешних факторов.
- Благодаря очень легкой отделке кожа приятная на ощупь.
- Это одноцветная кожа.

## КОЖА GRANADA

**Вид:** кожа лицевая, закрытая, полуаналиновая из экзотических коров.

### Характеристика:

- Лицо (верхний слой) с очень легкой формовкой, благодаря чему её фактура сохранена и на её поверхности отлично видны мелкие натуральные черты, такие как, например рубцы и жилки.
- Во время отделки этот вид кожи подвергается небольшой обработке, что позволяет сохранить как можно больший уровень натуральности, а также получить гладкость и эластичность. Используются небольшие количества красок и отделочных материалов - с одной стороны это позволяет на сохранение натурального узора на поверхности кожи, а с другой стороны, повышает уровень охраны кожи от последствий ежедневной эксплуатации и внешних факторов.
- Благодаря очень легкой отделке кожа приятная на ощупь.
- Это двухцветная кожа – неоднородный, оттененный цвет.

# 2D creator

[www.DesignYourSofa.online](http://www.DesignYourSofa.online)



Если вы хотите самостоятельно сконфигурировать мягкий уголок или софу, поюзаясь одной из выбранных модульных систем, воспользуйтесь помощью программного приложения 2D Gala Collezione, доступной по адресу [www.DesignYourSofa.online](http://www.DesignYourSofa.online).

Достаточно компьютера с выходом в интернет и любого веб-браузера. Вам не нужно обладать какими-либо знаниями, связанными с дизайном или программированием. Программа очень простая и интуитивно-понятная. Разработана так, чтобы шаг за шагом провести Вас через процесс конфигурации мебели. На каждом из этапов, Вы можете пользоваться различного рода подсказками и объяснениями, благодаря которым, будете точно знать, что в данный момент нужно сделать и какой эффект можно получить.

## ЭТАПЫ ПРОЕКТИРОВАНИЯ В 2D

### Шаг 1 – подготовьте размеры помещения, в которое вы хотите поставить мягкую мебель.

Проектирование начните с формы комнаты и расположения препятствий, в ней находящихся. Препятствия - это элементы оснащения, такие как корпусная мебель, цветочные горшки, колонны, поддерживающие потолок, если имеются, двери, перегородки и многое другое.

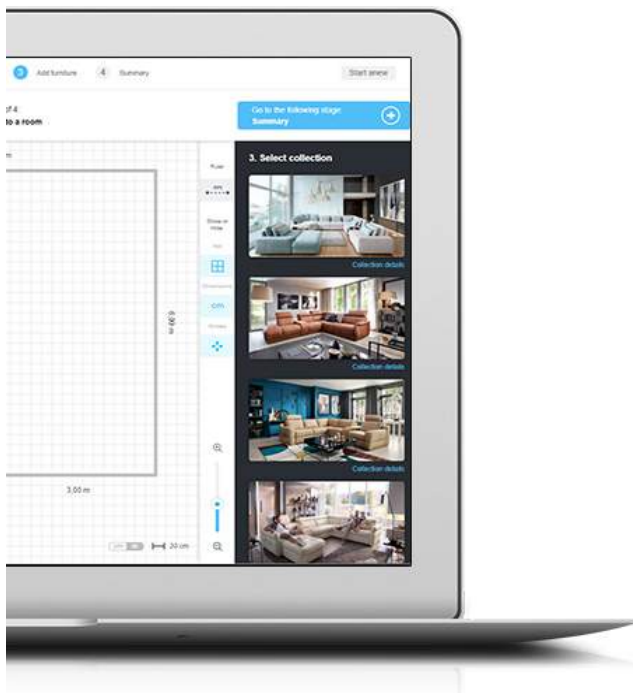

### Почему это важно?

- благодаря этому, вы будете знать, поместится ли созданный вами мягкий уголок или софа в помещении и возможно ли будет свободное прохождение и беспрепятственный доступ к окнам, балкону, столу в столовой и т. д.,
- определяя размеры помещения, Вы определяете масштаб, в котором будет проектироваться предмет мебели – благодаря этому система сама выберет размер конкретного твердого тела (мебельного элемента) таким образом, чтобы оно соответствовало размерам помещения.

### Шаг 2 – выберите модульную систему, которая Вам нравится

В любой момент Вы можете прочитать описание выбранной Вами коллекции и ознакомиться с функциями, которые можно применить в этом предмете мебели. После выбора модульной системы – Вы можете приступить к конфигурированию мягкой мебели. Из списка доступных элементов Вы выбираете те, которые Вас интересуют. Программа в текущем режиме будет вам подсказывать, какие элементы можно соединять друг с другом, чтобы можно было без проблем пользоваться их функциями (например, функцией сна или функцией релаксации).

### Шаг 3 – распечатайте свой проект и купите мебель

После завершения проектирования можно распечатать рисунок сконфигурированной мягкой мебели и перечень элементов из которых она состоит. Возьмите их с собой в мебельный салон, в котором Вы собираетесь приобретать мебель. Продавец сможет сразу же принять Ваш заказ, а Вы сосредоточитесь исключительно на выборе цвета и вида обивки.

# Для дизайнеров интерьера



Если вы профессионально занимаетесь проектированием и дизайном интерьера, добро пожаловать в ЗОНУ ДИЗАЙНЕРА на нашем сайте [www.GalaCollezione.com](http://www.GalaCollezione.com). Здесь вы найдете набор материалов и полезных инструментов, которые помогут вам в повседневной работе и подготовке уникальных и привлекательных проектов интерьера для ваших клиентов.

**ЗОНА ДИЗАЙНЕРА** - это обширный, постоянно обновляемый раздел, содержащий, в частности:

- библиотеки CAD, содержащие фигуры 3D для новых коллекций мебели марки Gala Collezione; библиотеки были подготовлены в четырёх самых популярных форматах: DWG, OBJ, MAX и 3DS и упакованы в удобные для загрузки файлы,
- библиотеки цветов и фактур натуральной кожи, самых популярных тканей, а также оттенков древесины, из которой изготовлены ножки, столешницы и другие деревянные элементы,

- электронные версии актуальных каталогов мебели, предлагаемых Фабрикой мебели Gala Collezione.

Все материалы доступны бесплатно и без регистрации. Вы можете скачать их в любой момент на свой компьютер, выбрав формат, который наиболее Вам подходит. Сгруппированы в нескольких отдельных закладках, чтобы было легче найти необходимые материалы.

Скачать файлы 3D



# Интеллектуальные решения

## Функция сна. Способы раскладывания мебели:



### Тип А или ДЕЛЬФИН

Выдвинуть из-под диванного сиденья выдвижной блок - тележку, а затем слегка приподнять его, создавая с сиденьем единую поверхность.



### Тип В или ЛЕОПАРД

Слегка приподнять фронтальную часть дивана, а затем потянуть на себя, нижняя (внутренняя) часть при этом поднимется и станет на освободившееся место, образуя удобную кровать.



### Тип С или Тележка

Выдвинуть тележку из-под мебели, потянув её в свою сторону, а затем перевернуть сиденье, чтобы выровнять поверхность для сна.



### Тип D или СЕДАЛИФТ

Выдвинуть тележку, а затем развернуть матрас, и складную ножку, которая поддерживает конструкцию. Удобство обеспечивает более толстый матрас.



### Тип Е или БЕЛЬГИЙСКИЙ СТЕЛЛАЖ

Конструкция напоминает раскладушку и подобным образом раскладывается. Нужно снимать сиденья перед раскладыванием дивана.



### Тип F или ИТАЛЬЯНСКИЙ СТЕЛЛАЖ

Раскладушка, спрятанная внутри. Потянуть на себя за ручку, расположенную в верхней части спинки и разложить стеллаж, на котором находится матрас.



### Тип G или DL

Выдвинуть сиденье на себя, а в освободившееся пространство опустить спинку так, чтобы получить ровную поверхность для сна.



### Тип H или C. S. T.

В этом случае мягкая мебель раскладывается как традиционный диван-кровать.

## Другие функции



### ФУНКЦИЯ РЕЛАКСАЦИИ

Это возможность регулировки угла наклона спинки и подножки, благодаря которой Вы можете легко отдохнуть в любом положении, от положения сидя до полулёжа. Функция релаксации может запускаться вручную (собственной мышечной силой) или с помощью электрических датчиков, спрятанных между сиденьем и боковиной предмета мебели. Электрическая функция релаксации может осуществляться путём подачи питания от аккумулятора или подачи тока от гнезда электропитания.



### ПОДГОЛОВНИКИ

Подвижные подголовники, благодаря постепенной регулировке угла их наклона, обеспечивают комфортную поддержку шеи во время чтения, просмотра телевизора и отдыха. Как вариант - подголовники можно переложить на любую спинку.



### БАР

С отделениями, открываемыми вверх, с ящиком, выдвигающимся вперёд, с деревянной столешницей, которую Вы можете использовать в качестве столика, со столешницей с кожаной или тканевой обивкой, треугольные, прямоугольные, с отделениями для стаканов – в наличии имеется широкий ассортимент баров, предлагающих множество возможностей.



### ПОДВИЖНОЕ СИДЕНИЕ

Подвижное сидение с электрическим механизмом управления – это гарантия возможности повышения его глубины. После выдвижения вы можете с успехом использовать сидение как поверхность для сна для одного человека. Также Вы можете использовать его для пассивного отдыха в положении лёжа.



# Объяснение пиктограмм

 Модульная система	 Ручной механизм раскладывания мебели (функция „релакс“)	 Мини-бар
 Функция сна - Тип А или ДЕЛЬФИН	 Электрический механизм раскладывания мебели (функция „релакс“) - необходимо подключить мебель к электрической розетке с помощью кабеля	 Возможность выбора типа обивки (ткань или кожа)
 Функция сна - Тип В или ЛЕОПАРД	 Электрический механизм раскладывания мебели (функция „релакс“) - мебель с аккумуляторным питанием, без необходимости подключения к розетке	 Возможность выбора цвета ткани
 Функция сна - Тип С или Тележка	 Электрический механизм раскладывания мебели (функция „релакс ПЛЮС“) - необходимо подключить мебель с помощью кабеля к электрической розетке	 Возможность сочетания не менее чем двух цветов (кожи с кожей, кожи с тканью, ткани с тканью)
 Функция сна - Тип D или СЕДАЛИФТ	 Электрический механизм раскладывания мебели (функция „релакс ПЛЮС“) - мебель с аккумуляторным питанием, без необходимости подключения к розетке	 Возможность выбора цвета нити
 Функция сна - Тип E (бельгийский стеллаж)	 Подвижные подлокотники	 Декоративные деревянные элементы (полки, столешницы)
 Функция сна - Тип F (итальянский стеллаж)	 Подвижные подлокотники с системой SM (Механизм защиты)	 Вращающееся кресло
 Функция сна - Тип G (DL)	 Подвижное сиденье, управляемое с помощью кнопок управления	 Возможность выбора типа основания
 Функция сна - Тип H (C.S.T.)	 Подвижная спинка	 Ножки деревянные (возможность выбора цвета древесины)
 Наполнитель TOP ELASTIC	 Подвижная спинка с системой CAR (Система автоматического регулирования)	 Хромированные ножки
 Высокоэластичная пена	 Подвижные подголовники, являющиеся неотъемлемой частью мебели, со ступенчатой регулировкой наклона	 Металлические ножки
 Пенополиуретан	 Подвижные подголовники с системой CAR (Система автоматического регулирования)	 Пластиковые ножки
 Силиконовый вкладыш	 Дополнительные, съемные подголовники, с возможностью установки на любой спинке мебели	 Колеса
 Волнистые пружины	 Спинка со свободными подушками	 Ноги - платформы
 Пружинный блок боннель	 Ящик для постельных принадлежностей	 Минимальное расстояние от стены мебели с функцией „релакс“

## Примечания:

Фактический размер мебели может отличаться от размеров, заявленных в коммерческом предложении Производителя. Допустимое отклонение от заявленного размера составляет:

- +/- 2 см, если заявленный параметр (ширина, глубина или высота мебели в конфигурации, готовой к эксплуатации) меньше или равен 150 см,
- +/- 2,5 см, если заявленный параметр (ширина, глубина или высота мебели в конфигурации, готовой к эксплуатации) больше 150 см,

- Мебельные модули и отдельно стоящие кресла с мануальной функцией релаксации доступны исключительно в обивке из кожи.
- Мебель Gala Collezione - это, прежде всего, мебель для отдыха, поэтому желательно, чтобы функция сна использовалась только время от времени.
- Аудиопанель изъята из ассортимента. Несмотря на то, что она изображена на некоторых фотографиях, она больше не доступна в продаже.

# Cuirs et tissus

Les meubles Gala Collezione sont disponibles dans une très large gamme de couleurs, et dans les cuirs et tissus de la plus haute qualité. C'est pourquoi vous pouvez choisir le matériau de revêtement pour votre salon, avec la structure et les couleurs les plus appropriées en fonction de vos besoins et la conception de votre salon.

Tous les cuirs naturels utilisés dans la production de meubles de salon de Gala Collezione viennent des meilleures tanneries. Chaque peau est sélectionnée et coupée par les découpeurs expérimentés et vous pouvez avoir la certitude que les meubles que vous choisirez pour le salon auront le tissu de la meilleure qualité. Les cuirs pour les meubles sont disponibles dans des dizaines de nuances - sur la base des échantillons disponibles dans les salons de meubles vous pouvez choisir la couleur qui vous plaira le plus. Ce genre de revêtement d'ameublement confère à vos meubles une élégance hors du temps en soulignant leur design.

Dans l'offre de Gala Collezione il y a des tissus de différentes propriétés et textures, notamment des tissus tissés, velvets, tricots, fibres textiles floquées et chenilles. Ces tissus se différencient entre eux non seulement par leur aspect mais aussi par leurs paramètres techniques. Tous les tissus de notre offre sont assortis pour garantir un usage prolongé et facile du meuble. Leur gamme de coloris est très étendue et qu'elle peut satisfaire les clients les plus exigeants.

N'oubliez pas que l'épaisseur du tissu ne signifie pas toujours sa plus grande durabilité. En choisissant le tissu pour votre meuble faites attention aux différents paramètres, tels que: la présence de certains enduits qui empêchent l'absorption des liquides, qui facilitent le nettoyage à l'eau, qui confèrent plus de résistance à l'abrasion (définie par le test de Martindale), qui augmentent la résistance au pilling (boulochage) et la résistance au UV, ou qui protègent contre les accrocs et les déformations. Le cuir dont la structure empêche les accrocs est adapté aux personnes ayant des animaux de compagnie.



### Cuir MADRAS

**Type:** cuir pleine fleur et fleur corrigée, à structure ferme, avec un marquage de type madras

**Caractéristique:**

- La pleine fleur (couche supérieure) a été estampée avec un motif délicat et régulier ce qui fait que sur sa surface les caractéristiques naturelles du cuir sont moins visibles en comparaison avec les cuirs lisses.
- Ce cuir est coloré et protégé par un vernis imperméabilisant qui augmente la résistance à l'abrasion et aide à le protéger des conséquences de l'utilisation quotidienne.
- C'est un cuir d'une seule teinte (uniformité de couleur)

### Cuir PEGASO

**Type:** cuir pleine fleur épaisse d'origine bovine, à structure fermée, avec un marquage de type Pegaso

**Caractéristique:**

- La pleine fleur (couche supérieure) ou fleur corrigée a été marquée d'un motif fin et régulier, avant la finition définitive de la surface ce qui fait que les caractéristiques naturelles de sa surface comme les morsures, les petites cicatrices, les veines ou les vergetures, sont moins visibles.
- Cette plus grande épaisseur a un effet positif sur les qualités utilitaires et du cuir et diminue la susceptibilité aux froissements.
- Ce cuir est coloré et imprégné d'un vernis imperméabilisant qui augmente la résistance à l'abrasion et protège des conséquences de l'utilisation quotidienne.
- C'est un cuir d'une seule teinte (uniformité de couleur) ou de deux teintes (la couleur n'est pas uniforme mais nuancée).

### Cuir FEDERICA

**Type:** cuir de bovins pleine fleur et fleur corrigée, épaisse, à structure ferme, ce cuir a été marquée d'un motif fin et régulier, federica

**Caractéristique:**

- La pleine fleur (couche supérieure) et fleur corrigée a été soumise à un marquage délicat ce qui fait que les motifs sur sa surface sont proches aux naturelles. On peut y apercevoir les petites caractéristiques naturelles comme cicatrices, petites veines et une structure diversifiée. Tout cela souligne l'origine naturel de la matière première. Le cuir est lisse et soyeux au toucher – présente une souplesse et élasticité ce qui fait qu'il se froisse moins et n'est pas susceptible aux ondulations au cours de l'utilisation.
- C'est un cuir d'une seule teinte (uniformité de couleur) ou de deux (la couleur n'est pas uniforme mais ombré); ce sont deux nuances de la même couleur et de la même palette. Le cuir est imprégné d'un vernis imperméabilisant qui augmente la résistance à l'abrasion et protège de l'influence des facteurs externes. Le cuir est traité par un procédé de finition qui consiste à l'application du vernis à base de silicone.

### Cuir MASSIVE

**Type:** cuir pleine fleur à structure fermée, semi-aniline

**Caractéristique:**

- La pleine fleur (couche supérieure) est marquée d'une façon délicate ce qui fait que sa structure naturelle est préservée. Sur la surface on y aperçoit les caractéristiques naturelles comme cicatrices ou petites veines.
- Dans le processus de finition ce cuir est traité délicatement pour garder au maximum sont naturel et afin qu'il soit lisse et soyeux au toucher. Utilisation d'une petite quantité de pigments et de substances de finition permet de garder un motif délicat sur la surface du cuir, et augmente aussi la résistance à l'usure et aux facteurs externes. Grâce au processus très délicat de finition le
- Grâce au processus très délicat de finition le cuir est agréable et doux au toucher.
- C'est un cuir d'une seule teinte (uniformité de couleur).

### Cuir GRANADA

**Type :** cuir pleine fleur à structure ferme, semi-aniline, provenant de vaches exotiques.

**Caractéristique :**

- La pleine fleur (couche supérieure) est marquée d'une façon très délicate ce qui fait que sa structure naturelle est préservée. Sur la surface on y aperçoit les caractéristiques naturelles comme cicatrices ou petites veines.
- Le processus de finition n'est que légèrement mis à contribution pour préserver un aspect très naturel et pour obtenir une texture lisse et douce
- De petites quantités de pigments et d'agents de finition y sont utilisées, ce qui permet, d'une part, de conserver le motif naturel de la surface et, d'autre part, d'augmenter la résistance à l'usure et aux facteurs externes.
- Grâce à un processus de finition très délicat, le cuir est agréable et chaleureux au toucher.
- Il s'agit d'un cuir bicolore, c'est-à-dire dont la couleur est inégale et légèrement nuancée.



# Outil de planification

Si vous voulez configurer vous-mêmes un canapé d'angle ou un sofa parmi les systèmes modulaires choisis, utilisez l'Outil de conception 2D Gala Collezione qui est disponible sur le site [www.DesignYourSofa.online](http://www.DesignYourSofa.online).

Il suffit d'avoir un ordinateur avec l'accès à l'Internet et un navigateur internet quelconque. Vous n'avez pas besoin d'avoir des connaissances liées avec la réalisation des projets ou la programmation. L'outil 2D est facile à utiliser et très intuitif. Il a été conçu pour vous guider, étape par étape, à travers le processus de configuration du meuble. A chaque de ces étapes vous pouvez bénéficier de différentes suggestions et conseils grâce auxquels vous saurez exactement ce que vous devez faire dans un moment donné et quel résultat vous obtiendrez.

## ÉTAPES DE CONCEPTION AVEC L'OUTIL 2D

### Étape 1 – préparez les dimensions de l'habitation dans laquelle vous voulez installer le sofa.

Commencez la préparation du projet par dessiner la forme de la pièce et indiquer les obstacles qui s'y trouvent. Les obstacles ce sont les éléments d'aménagement d'intérieur, comme meubles, pots de fleurs, éventuellement les piliers supportant le plafond, les portes, les cloisons etc.



### Pourquoi ceci est important?

- grâce à cette opération vous saurez si le sofa que vous avez dessiné rentrera dans l'habitation et si on pourra garder une communication confortable à travers la pièce et avoir un accès facile aux fenêtres, au balcon, à la table dans le coin repas.
- en spécifiant les dimensions de l'habitation vous définissez l'échelle dans laquelle vous dessinerez votre meuble. Le système choisira tout seul la taille du module concret pour qu'il soit en accord avec les dimensions.

### Étape 2 – choisissez le système modulaire qui vous plait le plus

A chaque moment vous pouvez lire la description de la collection que vous avez choisie et se familiariser avec les fonctionnalités que vous pouvez introduire dans chaque meuble. Quand vous choisirez le système modulaire vous pouvez commencer à configurer le sofa. De la liste de modules disponibles vous choisirez ceux qui vous intéressent le plus. L'outil va vous suggérer quels modules pourrait-on assembler pour pouvoir utiliser sans problèmes leurs fonctions (p.ex. déplier la fonction lit ou fonction relax).

### Étape 3 – imprimez le résumé et achetez le meuble

Après la phase de la conception vous pouvez tout de suite imprimer le résumé qui contient les dessins du sofa configuré avec la spécification des modules choisis. Apportez-les au salon de meubles dans lequel vous voulez acheter votre meuble. Le vendeur pourra accepter immédiatement votre commande et vous vous concentrerez uniquement sur le choix de la couleur et le type de revêtement.

# Pour les designers d'intérieur



Si vous vous occupez professionnellement ou par vocation de la décoration et de l'architecture des intérieurs nous vous invitons à la **ZONE DU DESIGNER** sur notre site internet [www.GalaCollezione.com](http://www.GalaCollezione.com). Vous y trouverez un dossier de matériaux et d'outils pratiques qui peuvent vous aider dans votre travail quotidien et à la création des projets uniques et attrayants d'aménagement des intérieurs pour vos clients.

La **ZONE DU DESIGNER** est une section riche en fonctionnalités et systématiquement développée qui contient entre autres :

- bibliothèque CAD contenant les modules 3D pour les plus récentes collections de meubles de la marque Gala Collezione. Les bibliothèques ont été préparés dans quatre formats le plus courants : DWG, MAX et 3DS et enfermés en paquets faciles à télécharger,
- bibliothèques de couleurs et textures de cuirs naturels, des tissus les plus populaires et des colorations du bois, dont on a fait les pieds, panneaux et d'autres éléments,

- versions électroniques de catalogues actuels des meubles que nous avons dans l'offre de notre usine Fabryka Mebli Gala Collezione.

Tous ces matériaux sont disponibles gratuitement et sans besoin de se connecter. Vous pouvez les télécharger à un moment donné sur votre ordinateur en choisissant le format qui vous convient le mieux. Ils sont situés dans quelques onglets séparés pour que vous puissiez accéder plus facilement aux ressources dont vous avez besoin.

Téléchargez les  
bibliothèques 3D



# Solutions astucieuses

## Types de fonction de lit:



### Type A c'est-à-dire DAUPHIN

Tirez le chariot qui se trouve dans la partie basse du meuble et soulevez délicatement le matelas en mousse pour égaliser son niveau avec celui de l'assise.



### Type B c'est-à-dire LEOPARD

Soulevez délicatement le front du meuble et ensuite tirez vers soi pour sortir l'assise. La partie destinée au couchage s'élèvera automatiquement.



### Type C c'est-à-dire dit CHARIOT

Retirez le chariot du dessous du meuble en le tirant vers soi, ensuite tournez à l'envers l'assise pour égaliser la surface de couchage.



### Type D c'est-à-dire SEDALFIT

Tirez le chariot, déployez le matelas et le pieds pliant qui sur lequel s'appuie la construction. Un matelas plus épais assure la commodité.



### Type E c'est-à-dire CHASSIS BELGE

Cette construction ressemble à un lit de camp et on le déplie de manière similaire. Pour déplier le meuble il faut enlever l'assise.



### Type F c'est-à-dire CHASSIS ITALIEN

Tirez vers vous la poignée qui se trouve au sommet du dossier et déployez le châssis sur lequel est posé le matelas.



### Type G c'est-à-dire DL

Tirez l'assise vers vous et ensuite déployez le dossier du meuble pour obtenir une surface plane pour dormir.



### Type H c'est-à-dire C.S.T.

Ce meuble avec fonction lit on le déplie comme un canapé-lit traditionnel.

## Autres fonction:



### Fonction relaxation

Cela signifie qu'il existe la possibilité de régler l'angle d'inclinaison du dossier et du repose-pied. Grâce à ce système, vous pouvez vous reposer dans toutes les positions depuis la position assise jusqu'à semi-allongée. La fonction de relaxation peut être déplié manuellement (avec la force de ses propres muscles) ou avec des boutons de commande. Fonction électrique de relaxation peut être alimenté par batterie ou directement par le secteur.



### Appui-têtes

Les appui-têtes inclinables, grâce à l'ajustement graduel de l'angle d'inclinaison, assurent un appui confortable pour la nuque pendant la lecture, le repos, et les moments passés devant la télévision. En option, les appui-têtes amovibles peuvent être remis sur un dossier quelconque.



### Bar

Il y a beaucoup de types de bars qui offrent toute une gamme de possibilités: bar avec des rangement à ouverture par le dessus, avec un tiroir de coulissant vers l'avant, bar avec un panneau en bois que vous pouvez utiliser comme une table, bar avec un panneau capitonné en cuir ou en tissu, bars triangulaires, rectangulaires, avec porte-gobelets, bars situés au milieu ou à l'extrémité (à la fin du module).



### Assise coulissante

Ce type de siège à commande électrique donne la possibilité d'augmenter sa profondeur. Après avoir déplié le siège vous pouvez vous reposer dans la position assise ou semi-allongée.

# Explication de pictogrammes

 système modulaire	 fonction de relaxation – le meuble est déplié et replié manuellement	 bar avec un coffre
 fonction lit type A (DAUPHIN)	 fonction de relaxation – le meuble est déplié et replié électriquement – il faut le connecter au secteur à l'aide d'un câble.	 possibilité de choisir le type de revêtement (tissu ou cuir)
 fonction lit type B (LEOPARD)	 fonction de relaxation – le meuble est déplié et replié électriquement – il fonctionne sur batterie. On n'a pas besoin de le connecter au secteur.	 possibilité de choisir la couleur du tissu de revêtement
 fonction lit type C (CHARIOT)	 fonction de relaxation PLUS - le meuble est déplié et replié électriquement – il faut le connecter au secteur à l'aide d'un câble.	 possibilité de composer au moins deux couleurs (cuir et cuir, cuir avec tissu ou tissu avec tissu)
 fonction lit type D (SEDALIFT)	 fonction de relaxation PLUS - le meuble est déplié et replié électriquement – il fonctionne sur batterie. On n'a pas besoin de le connecter au secteur.	 possibilité de choisir la couleur du fil
 fonction lit type E (châssis belge)	 accoudoirs relevables	 éléments décoratifs en bois (étagères, panneaux)
 fonction lit type F (châssis italien)	 accoudoirs relevables avec le système SM (Safe Mechanism)	 fauteuil pivotant
 fonction lit type G (DL)	 assise coulissante, réglé par des capteurs électriques	 possibilité de choisir le type de la base
 fonction lit type H (C.S.T.)	 dossier relevable	 pieds en bois (possibilité de choisir la couleur du bois)
 rembourrage TOP ELASTIC	 dossier relevable avec le système de retour automatique	 pieds chromés
 mousse haute densité	 appui-têtes inclinables qui constituent une partie intégrante du meuble avec réglage graduel d'inclinaison	 pieds en métal
 mousse polyuréthane	 appui-têtes inclinables avec le système de retour automatique	 pieds en plastique
 intérieur en silicone	 En option : appui-têtes amovibles qu'on peut installer sur un dossier quelconque du meuble	 roulant
 ressorts Nosag	 dossier avec coussins de décoration	 pieds métalliques style industriel (en forme de patins)
 ressorts Bonell	 coffre de rangement pour la literie	 La distance minimale entre le mur et le meuble avec fonction de relaxation

## Explications supplémentaires:

La taille réelle du meuble peut différer de la taille déclarée dans l'offre commerciale du Fabricant. La tolérance par rapport à la dimension déclarée est de:

- +/- 2 cm, si la taille déclarée (largeur, profondeur ou hauteur du meuble dans une configuration prête à l'emploi) est inférieure ou égale à 150 cm.
- +/- 2,5 cm, si la taille déclarée (largeur, profondeur ou hauteur du meuble dans une configuration prête à l'emploi) est supérieure à 150 cm.

- Les modules et le fauteuil avec fonction relax sont disponibles exclusivement avec le revêtement en cuir.
- Les meubles Gala Collezione ce sont avant tout les meubles de repos il est donc préférable qu'on utilise la fonction lit uniquement de façon occasionnelle.
- Le panneau audio visible sur certaines photos du catalogue a été retiré de notre offre et n'est plus disponible.

[www.GalaCollezione.com](http://www.GalaCollezione.com)