





NORLYS is a Scandinavian company with a 50 years history in the professional lighting business. We offer one of the largest product ranges in decorative outdoor lighting and we deliver highest quality all over the world.

No secret: our quality comes from the choice of excellent raw-material in combination with a perfectly controlled production process. All our products are made in Europe in our own ISO 9001 certified factory. On a surface of more than 15000m² we use most modern machines and equipment. Steady investment keeps us on the top of the industrial process. A good example is our foundry, one of the most modern installations in Europe.

When we cannot do it alone, we carefully choose our partners. This is especially important in the field of LED technology. We use the best LED quality from the very best suppliers. No compromise allowed!

Good design, large choice, excellent quality: indeed that's what our customers appreciate! In this world of quick exchange it is equally important to work on high delivery-speed. This is why we have several very large warehouses with thousands of finished products ready to be shipped. If something is not already in stock, we produce within days.

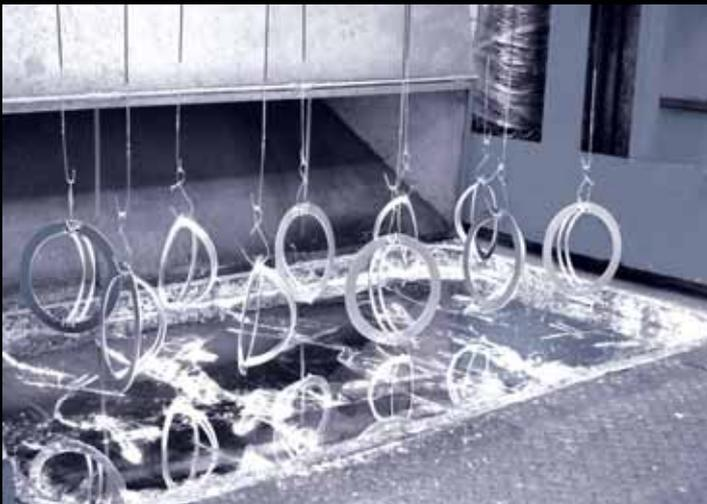
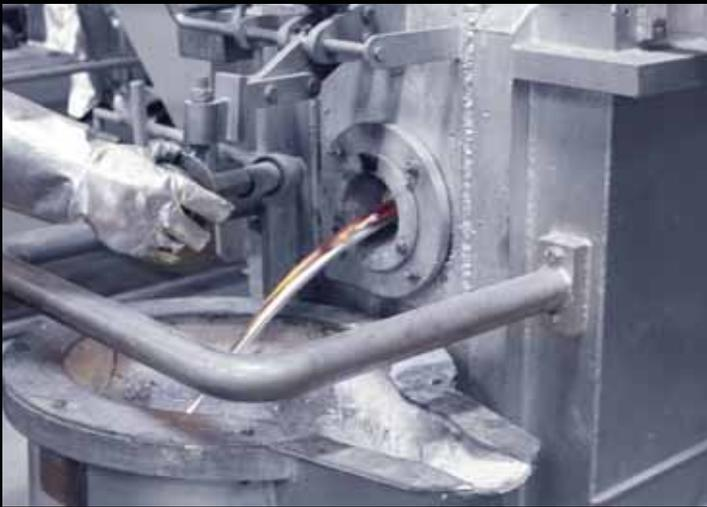

No pictures contained in this catalogue can be reproduced, even partially. The Company reserves the right to change technical and aesthetic characteristics of illustrated products at any times, in order to increase constantly their quality and performance without written notice.

LIGHT SOURCE / SOCKET

LIGHT SOURCE

SOCKET

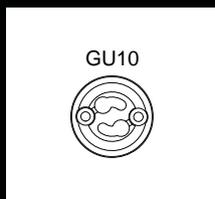
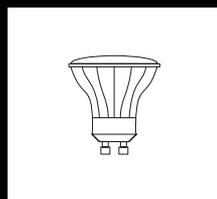
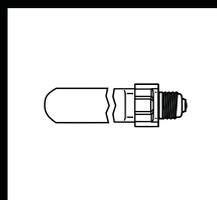
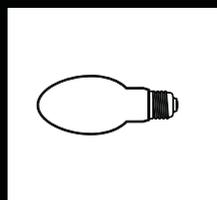
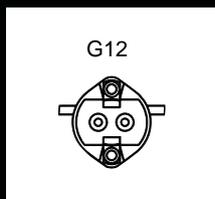
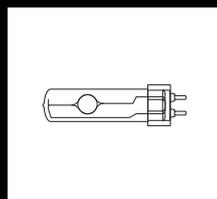
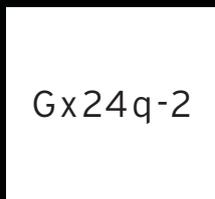
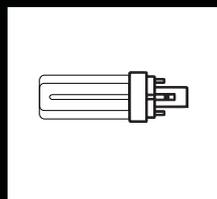
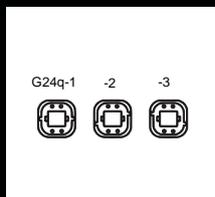
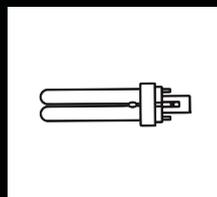
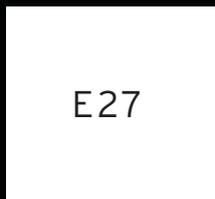
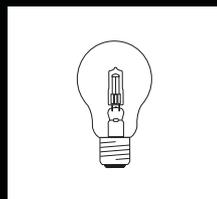

NORLYS offers a large variety of lamp options. Please refer to the concerned product page for details. The large majority of our products is delivered without lamp.

Many fixtures are equipped with E27 lampholder. Please see below for equivalents between GLS and halogen lamps to be used. For example if a 60W incandescent lamp is recommended, you can use halogen lamps up to 46W. Alternatively you might use fluo compact lamps with integrated ballast or LED retrofit lamps for E27 lampholder. Do not hesitate to contact us for advise.

HALOGEN		GLS
30W	<=>	40W
46W	<=>	60W
57W	<=>	75W
77W	<=>	100W

In some exceptional cases our products are delivered with LED bulb(s). Originally this has been done to make sure that the right lamp is being used in the concerned fixture. In other cases it simply makes installation easier (see RENA inground fixtures).

Finally, you will as well find a large number of products with LED module. LED modules allow better cooling and optimized control of the light output. Certain fixtures use more than one module and in the case of VISBY for example, each module can be driven separately. As a result you have a fixture allowing many different applications (twilight detector, movement detector, different light output in function to your needs). LED modules are a good solution to save energy and to decrease maintenance cost over the time.

Design and technical details:

The characteristics of the models mentioned in this catalogue are not binding. Norlys reserves itself the right to change them without notice and without obligation of communication in according to its own technical constructive requirements and/or to improve the products.

Color temperatures (Kelvin)

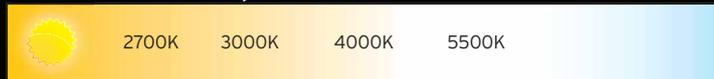

Look for LED products: See the green house



COLOR

COLOR CHART

Important: Each product number in the catalogue are specified with a standard color.
Other colors by request. Printed color images may differ from the real product.



ALUMINIUM, RAL 9006



GRAPHITE, RAL 7016



WHITE, RAL 9003



GALVANIZED STEEL



COPPER



BLACK, RAL 9005



STAINLESS STEEL



BLACK/GREEN



BLACK/COPPER



BLACK/GOLD

INDEX



ALTA
p. 70, 71



ARVIKA
p. 25



ASKER FAMILY
p. 40, 41



BASEL
p. 54, 55

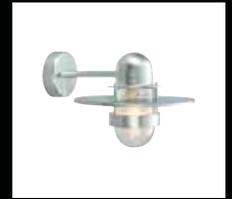

BERGEN FAMILY
p. 92, 93



BERLIN
p. 82, 83



BERN
p. 52, 53



BODEN
p. 56, 57



BOLOGNA FAMILY
p. 116, 117



BORNHOLM
p. 50



BREMEN
p. 80, 81



CHELSEA FAMILY
p. 94 - 97



COMO FAMILY
p. 118



EGERSUND FAMILY
p. 22, 23



FIRENZE
p. 119

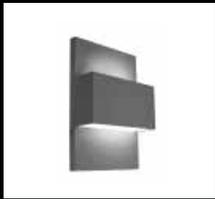

GENEVE
p. 42, 43



GENOVA
p. 98, 99



GENOVA MINI
p. 98



GLASGOW
p. 100, 101



GRIMSTAD
p. 36, 37



HALDEN
p. 48, 49



HALMSTAD FAMILY
p. 68, 69



HAMBURG
p. 82



HELSINKI FAMILY
p. 32, 33



KARLSTAD
p. 90, 91



KIRUNA
p. 32



KOSTER FAMILY
p. 16 - 19



LATINA
p. 101



LILLEHAMMER
p. 30, 31



LOFOTEN FAMILY
p. 102, 103

INDEX



LONDON FAMILY
p. 104 - 109



LUND FAMILY
p. 84, 85



MODENA FAMILY
p. 110 - 115



MOLDE
p. 64, 65



NEW
NAMSOS FAMILY
p. 34, 35



NARVIK
p. 24



NICE
p. 12, 13



NORDKAPP
p. 60, 61



NORDLAND
p. 58, 59



OSLO FAMILY
p. 86, 87



NEW
OPPLAND
p. 62, 63



PARIS
p. 88, 89



RENA
p. 38, 39



RIMINI/MILANO FAMILY
p. 120, 121



ROMA
p. 101



RONDANE
p. 50, 51



SANDE FAMILY
p. 26, 27



SANDVIK FAMILY
p. 44, 45



SCANDINAVIAN WOOD
p. 66, 67



NEW
STAVANGER
p. 20, 21



STOCKHOLM FAMILY
p. 72 - 79



SUNNFJORD
p. 8, 9



VANSBRO
p. 93



VASA
p. 46, 47



VENEDIG
p. 98



VISBY
p. 10, 11



VOSS
p. 28, 29



TELESCOPIC POLES
p. 14, 15



ACCESSORIES
p. 122, 123

SUNNFJORD



LED

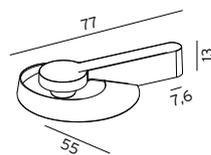

SUNNFJORD

IP55, class I

Ideally suited for use in communal areas such as car parks and walkways, Sunnfjord is a powder coated aluminium head.

For use on poles with 76mm external diameter at top.

Supplied with frosted lens

See also poles for use with Sunnfjord on p. 14

Art. 1507

46,7W LED 
Aluminium, 1507AL
Graphite, 1507GR
LED module: 6000 lm,
4000K, 60 000h, EE: A++

Art. 1508

31,5W LED 
Aluminium, 1508AL
Graphite, 1508GR
LED module: 4342 lm,
4000K, 60 000h, EE: A++

Accessories

Art. 1509
Adapter for 76/60mm
Aluminium, 1509AL
Graphite, 1509GR

Suitable to use with poles \varnothing 60mm





VISBY



Version LED

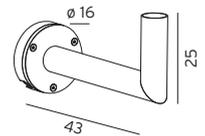
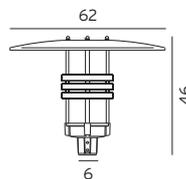

VISBY
IP65, class I
Ideally suited for use in communal areas such as car parks and walkways, Visby is a powder coated aluminium head fitted with a UV resistant polycarbonate lens.

For use on poles with 60mm external diameter at top.

Art. 575
70W HIT-CE, G12
Aluminium, 575AL
Graphite, 575GR
EEI: A+

Art. 576 
49,2W LED
Aluminium, 576AL
Graphite, 576GR

LED module (up)
30,4W, 3000 lm, 3000K
50 000h, EEI: A+

LED module (down)
18,8W, 2000 lm, 3000K
50 000h, EEI: A+

* Visby with 4000K available by request, contact your supplier

Art. 577 
30,4W LED
Aluminium, 577AL
Graphite, 577GR

LED module (up)
30,4W, 3000 lm, 3000K
50 000h, EEI: A+

Accessories
Art. 154
Aluminium, 154AL
Graphite, 154GR

Arm for use on wall with Visby, \varnothing 60mm.

See also poles for use with Visby on p. 14

NICE

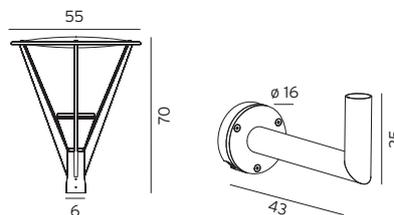
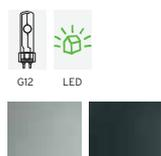

NICE
 IP65, class I
 Ideally suited for use in communal areas such as carparks and walkways. Powder coated aluminium head.

For use on poles with 60mm external diameter at top.

Art. 770
 70W HIT-CE, G12
 Aluminium, 770AL
 Graphite, 770GR
 EEI: A+

Art. 777 
 40,8W LED
 Aluminium, 777AL
 Graphite, 777GR
 LED module: 5127 lm,
 3000K, 50 000h, EEI: A++

Accessories
Art. 154
 Aluminium, 154AL
 Graphite, 154GR

Arm for use on wall with NICE, \varnothing 60mm.

See also poles for use with NICE on p. 14

* Nice with 4000K available by request, contact you supplier.



TELESCOPIC POLE

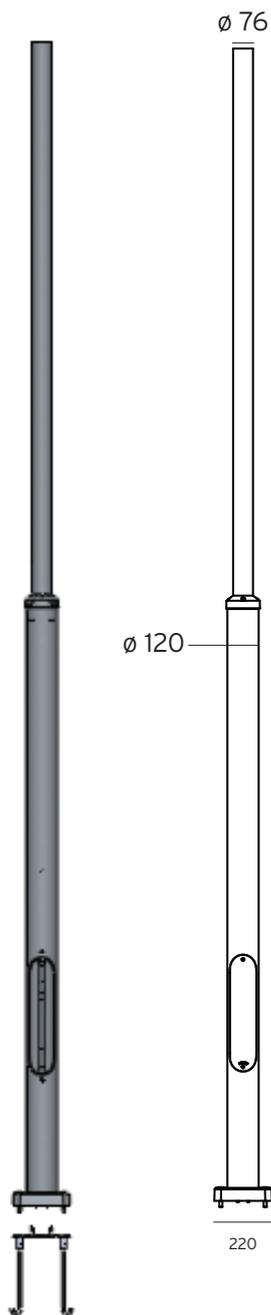

ART. 7661

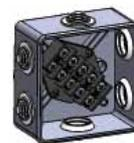

ART. 7662



Max=4490 mm

Min=3625 mm

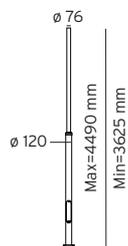

POLE

For use with products VISBY, SUNNFJORD, NICE and KOSTER.

Ideally suited for use in communal areas such as car parks and walkways.

The pole is telescopic and can be adjusted from: Minimum 3625mm to maximum 4490mm. Top tube $\varnothing 76$ mm.

Art. 3005

Included service door + anchors

Art. 3006

Included service door + anchors + art 7661

Art. 3007

Included service door + anchors + Art 7662, EK 480

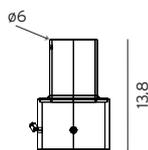

Accessories

Art. 7660

Adapter for 76/60mm (short version)

* Must be used with **VISBY and KOSTER Art. 727, 729, 1913** head $\varnothing 60$ mm

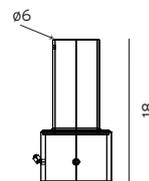

Accessories

Art. 7665

Adapter for 76/60mm (long version)

* Must be used with **NICE** head $\varnothing 60$ mm

ART. 7662

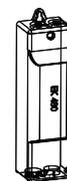

ART. 7661

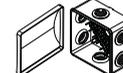

Accessories

Art. 7661

Electric box for pole 3006

Art. 7662

Electric box for pole 3007 (EK 480 G1S-2D)



KOSTER



LED



ART. 1913

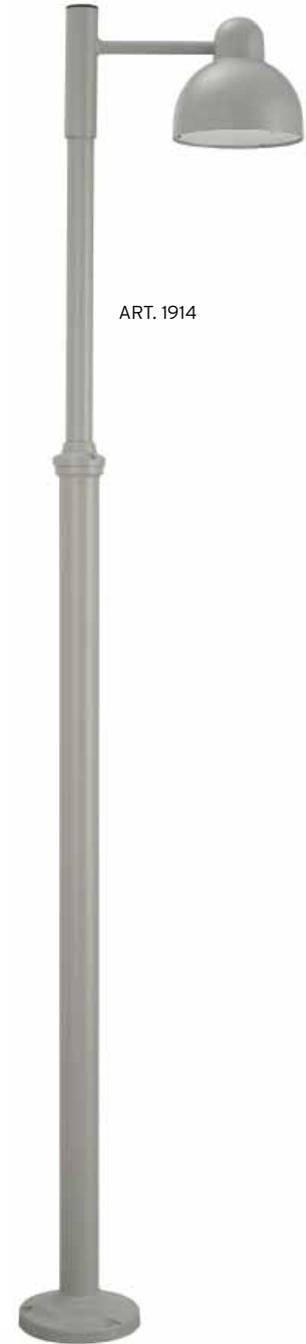

ART. 1914

KOSTER FAMILY →

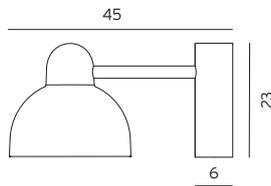

KOSTER LAMP HEAD

IP54, Class I
Ideally suited for use in communal areas such as car parks and walkways, Koster is a powder coated aluminium head supplied with optical structure polycarbonate lens.

Art. 1913: For use on poles with 60mm external diameter at top.

See also poles for use with Koster on p. 14

Art. 1913

18,8W LED Aluminium, 1913AL Graphite, 1913GR White, 1913W
LED module: 2000 lumen, 3000K, 50000h, EEI: A+

* Koster with 4000K available by request, contact your supplier.

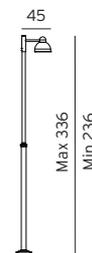

KOSTER TELESCOPIC POLE

IP54, class I
Ideally suited for use in communal areas such as car parks and walkways, Powder coated aluminium. Optical structure polycarbonate lens. Pole and head included.

Accessories for 1914

Art. 405
Concreting anchor

Art. 406
Anchoring support

Art. 1914

18,8W LED Aluminium, 1914AL Graphite, 1914GR White, 1914W
LED module: 2000 lumen, 3000K, 50000h, EEI: A+

* Koster with 4000K available by request, contact your supplier.





KOSTER

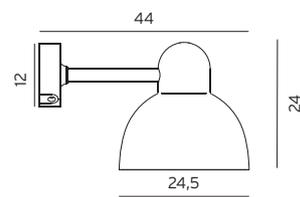
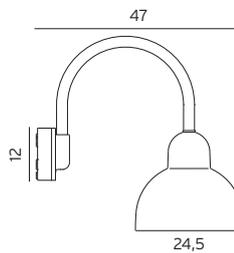

KOSTER
Powder coated aluminium wall light supplied with optical structure polycarbonate lens. IP54

Accessories
Art. 158
Corner bracket for Koster wall models. Aluminium, 158AL Graphite, 158GR White, 158W

Art. 720
77W Halo. max class II
Aluminium, 720AL Graphite, 720GR White, 720W
EEI: A+..D

Art. 1911
18,8W LED class I
Aluminium, 1911AL Graphite, 1911GR White, 1911W
LED module: 2000 lumen, 3000K, 50000h, EEI: A+

Art. 724
77W Halo. max class I
Aluminium, 724AL Graphite, 724GR White, 724W
EEI: A+..D

Art. 725
11,3W LED class I
Aluminium, 725AL Graphite, 725GR White, 725W
LED module: 1100 lumen, 3000K, 50000h, EEI: A+

Art. 1912
18,8W LED class I
Aluminium, 1912AL Graphite, 1912GR White, 1912W
LED module: 2000 lumen, 3000K, 50000h, EEI: A+

* Koster LED 2000 lumen with 4000K available by request, contact you supplier.



STAVANGER



LED



Frosted lens

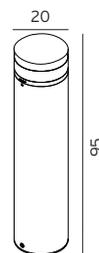

STAVANGER
IP65, class I
Powder coated aluminium bollard. Lens: UV stabilised polycarbonate, vandal resistant. Indirect LED light output.

Art. 1240, 1244 og 1247 delivered with clear lens

Art. 1243, 1246 og 1248 delivered with frosted lens

Accessories for Stavanger bollards

Art. 1230
Concreting anchor for Stavanger range.

Art. 1231
Anchoring support for Stavanger range.



Art. 1240
14,7W LED 
Clear lens
Aluminium, 1240AL
Graphite, 1240GR
LED module: 1380 lumen,
3000K, 50000h, EEI: A+

Art. 1244
14,7W LED 
Clear lens
Aluminium, 1244AL
Graphite, 1244GR
LED module: 1380 lumen,
3000K, 50000h, EEI: A+

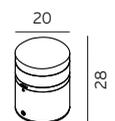

Art. 1247
7W LED 
Clear lens
Aluminium, 1247AL
Graphite, 1247GR
LED module: 750 lumen,
3000K, 50000h, EEI: A+

* Stavanger with LED, 4000K available by request, contact your supplier.

Art. 1243 New!
E27, 46W Halo. max.
Frosted lens
Aluminium, 1243AL
Graphite, 1243GR
EEI: A+.D

Art. 1246 New!
E27, 46W Halo. max.
Frosted lens
Aluminium, 1246AL
Graphite, 1246GR
EEI: A+.D

Art. 1248 New!
E27, 46W Halo. max.
Frosted lens
Aluminium, 1248AL
Graphite, 1248GR
EEI: A+.D



EGERSUND MINI

NEW



LED



EGERSUND



LED

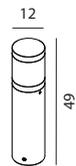
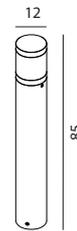
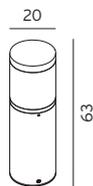

EGERSUND

IP65, class I
Powder coated aluminium bollard. Clear PMMA lens.

Indirect LED light output.

Egersund Art. 1280

20,3W LED
Aluminium, 1280AL
Graphite, 1280GR
LED module: 2240 lm,
3000K, 50000h, EEI: A+



Egersund Art. 1285

20,3W LED
Aluminium, 1285AL
Graphite, 1285GR
LED module: 2240 lm,
3000K, 50000h, EEI: A+



EGERSUND MINI

IP65, class I
Powder coated aluminium bollard. Clear PMMA lens
Indirect LED light output.

New!

Egersund Mini Art. 1290

13,2W LED
Aluminium, 1290AL
Graphite, 1290GR
LED module: 1360 lm,
3000K, 50000h, EEI: A+,
dimmable (Triac)



Egersund Mini Art. 1291

13,2W LED
Aluminium, 1291AL
Graphite, 1291GR
LED module: 1360 lm,
3000K, 50000h, EEI: A+,
dimmable (Triac)



Accessories for Art. 1280, 1285

Art. 1230

Concreting anchor

Art. 1231

Anchoring support

Accessories for Art. 1290, 1291

Art. 205

Concreting anchor

Art. 206

Anchoring support

* Egersund with 4000K available by request, contact you supplier.

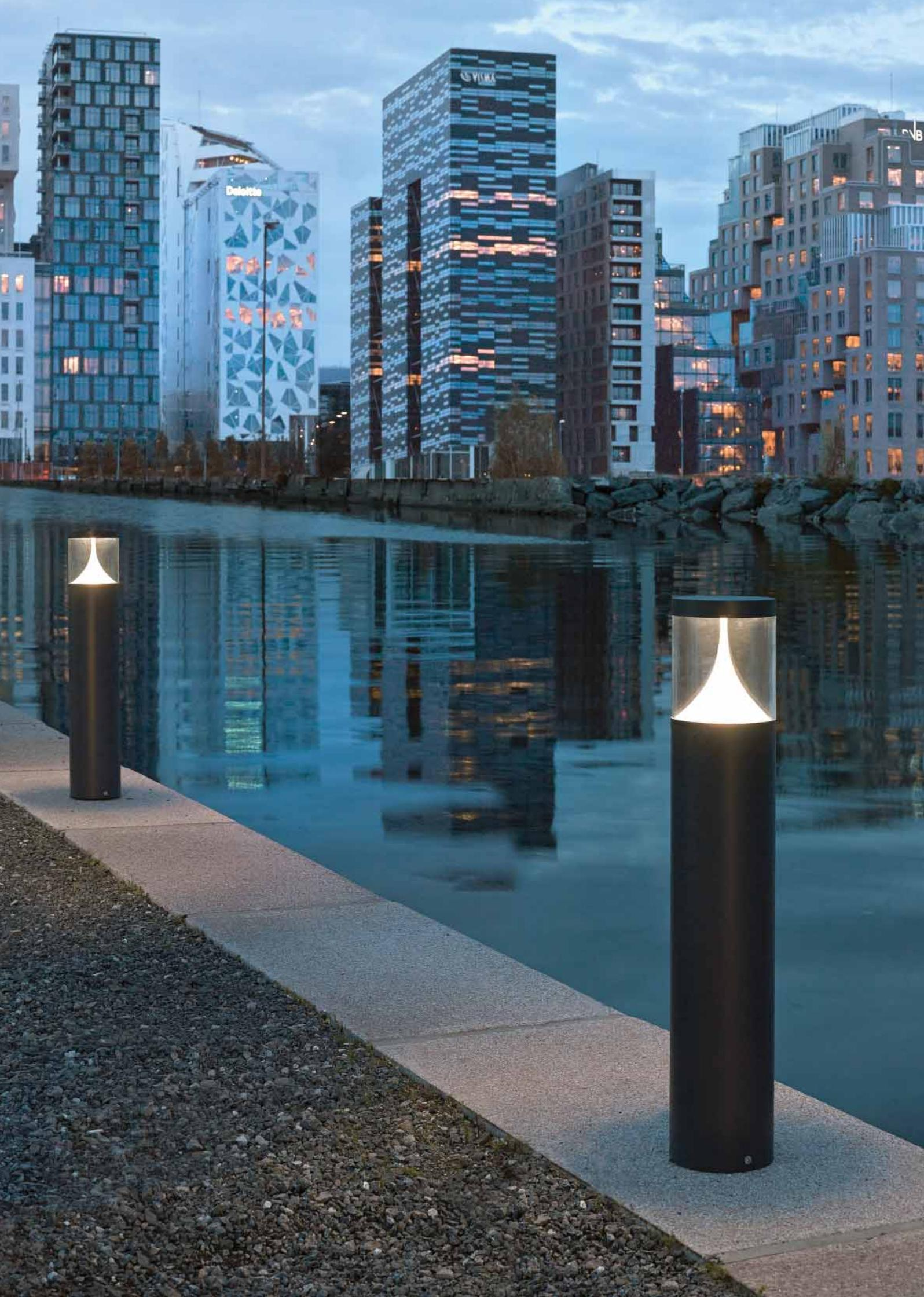



NARVIK



G12

LED

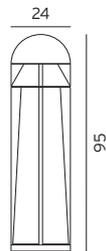

NARVIK

IP65, class I
Heavy duty bollard.
Powder coated aluminium
bollard. Glare free with
indirect light effect on
internal conical tube. Lens
stabilised polycarbonate,
vandal resistant.

Concreting anchor:
included.

Art. 552

35W HIT-CE, G12
Aluminium, 552AL
Graphite, 552GR
White, 552W
EEI: A++

Art. 557

24,9W LED 
Aluminium, 557AL
Graphite, 557GR
White, 557W
LED module: 3100 lm,
3000K, 50000h, EEI: A++

* Narvik with 4000K
available by request,
contact your supplier.



ARVIKA



G12 GX24q-2



ARVIKA IP44, class I

Arvika can be delivered with normal jack contacts automatic fuses and earth fault. See Art 894 or 895

Accessories

Supplied with concrete anchor kit as standard.

Art. 890
35W, G12
Galvanized steel, 890GA
Black, 890B
EEI: A+

Art. 892
18W, Gx24 q-2
(OSRAM DULUX T/E included)
Galvanized steel, 892GA
Black, 892B
EEI: B

Art. 894 (normal jack contacts)
35W, G12
Galvanized steel, 894GA
Black, 894B
EEI: A+

Art. 895 (normal jack contacts)
18W, Gx24 q-2
(OSRAM DULUX T/E included)
Galvanized steel, 895GA
Black, 895B
EEI: B

* Option with LED will be ready during summer 2017
Check web for updates of new Art.nr or contact your supplier.

SANDE

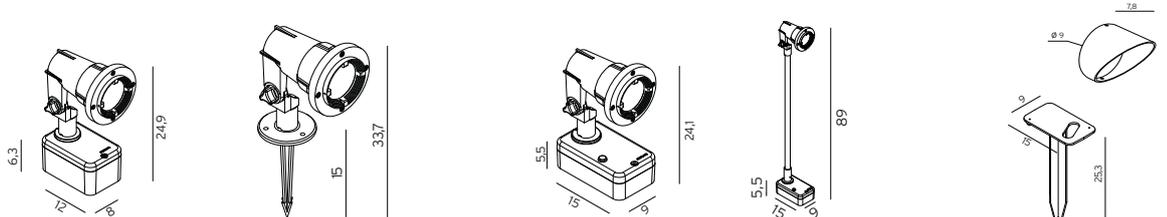

SANDE series 
IP65, class I

Landscape and shop lighting fixture in aluminium. Adjustable head for tilting.

Important
During 2017: 4W, GU10, 272lm, 3000K will be replaced by 5,4W, GU10 402 lm

Art. 1590
(Wall, short arm)
4W, LED, GU10, 40D
Graphite, 1590GR
Black, 1590B
4W LED GU10 included, 272 lm, 3000K, 50000h, 40D, EEL: A+

Art. 1591
(Wall, short arm)
7W, LED
Graphite, 1591GR
Black, 1591B
LED module: 750 lm, 3000K, 50000h, 40D, EEL: A+

Art. 1592
(5m cable and plug incl. spike)
4W, LED, GU 10
Graphite, 1592GR
Black, 1592B
4W LED GU10 included, 272 lm, 3000K, 50000h, 40D, EEL: A+

Art. 1593
(5m cable and plug incl. spike)
7W, LED
Graphite, 1593GR
Black, 1593B
LED module: 750 lm, 3000K, 50000h, 40D, EEL: A+
(For use as wall application remove spike)

Art. 1594
(Ground, short arm)
7W, LED
Graphite, 1594GR
Black, 1594B
LED module: 750 lm, 3000K, 50000h, 40D, EEL: A+

Art. 1598
4W, LED, GU10, 40D
Graphite, 1598GR
Black, 1598B
4W LED GU10 included, 272 lm, 3000K, 50000h, 40D, EEL: A+

Art. 1596
(Ground, long arm)
7W, LED
Graphite, 1596GR
Black, 1596B
LED module: 750 lm, 3000K, 50000h, 40D, EEL: A+

Art. 1599
4W, LED, GU10, 40D
Graphite, 1599GR
Black, 1599B
4W LED GU10 included, 272 lm, 3000K, 50000h, 40D, EEL: A+

Accessories
Art. 1233
Cap

Accessories
Art. 1234
Spike for:
Art. 1594
Art. 1596
Art. 1598
Art. 1599



4B

VOSS

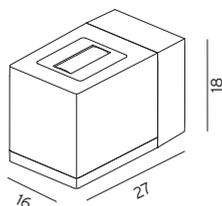

VOSS
IP 54, Class I

Die cast aluminium
up and down wall light.

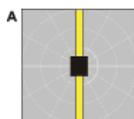

ART. 783
70W HIT-CE, G12
Aluminium, 783AL
Graphite, 783GR

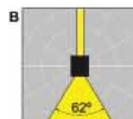

ART. 780
70W HIT-CE, G12
Aluminium, 780AL
Graphite, 780GR

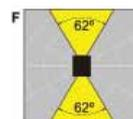

ART. 784
70W HIT-CE, G12
Aluminium, 784AL
Graphite, 784GR

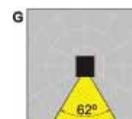

ART. 785
70W HIT-CE, G12
Aluminium, 785AL
Graphite, 785GR

ART. 1950 
21,6W LED
Aluminium, 1950AL
Graphite, 1950GR
LED module: 1830 lm,
3000K, 50000h, EEI: A+

ART. 1951 
14,9W LED
Aluminium, 1951AL
Graphite, 1951GR
LED module: 1220 lm,
3000K, 50000h, EEI: A+







LILLEHAMMER



LED

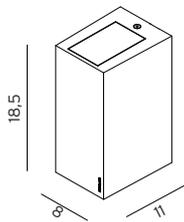

Lillehammer
IP 65, Class I

Die cast aluminium.
Clear glass.
Art 1580, 1582 and
1584 can be turned
both ways.

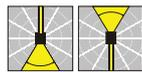

Art. 1580
2x3,7W LED
Aluminium, 1580AL
Graphite, 1580GR
White, 1580W
Black, 1580B
LED module: 2x305 lumen,
3000K, 50000h, EEL: A+



Art. 1581
2x3,7W LED
Aluminium, 1581AL
Graphite, 1581GR
White, 1581W
Black, 1581B
LED module: 2x305 lumen,
3000K, 50000h, EEL: A+

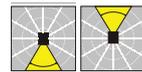

Art. 1582
3,7W LED
Aluminium, 1582AL
Graphite, 1582GR
White, 1582W
Black, 1582B
LED module: 305 lumen,
3000K, 50000h, EEL: A+



Art. 1583
2x3,7W LED
Aluminium, 1583AL
Graphite, 1583GR
White, 1583W
Black, 1583B
LED module: 2x305 lumen,
3000K, 50000h, EEL: A+

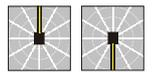

Art. 1584
3,7W LED
Aluminium, 1584AL
Graphite, 1584GR
White, 1584W
Black, 1584B
LED module: 305 lumen,
3000K, 50000h, EEL: A+

* Lillehammer with 4000K available by request, contact you supplier.

HELSINKI



KIRUNA

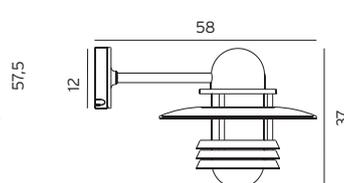
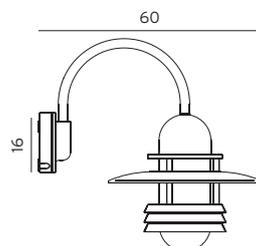
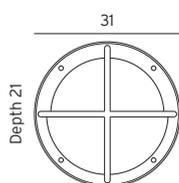

KIRUNA
IP 66, class II
Heavy duty anti vandal
fixture. Powder coated
aluminium. Supplied with
a 4mm anti vandal opal
UV polycarbonate lens.

Art. 594 opal lens.

(Options also available
with clear glass, contact
your supplier.)

Art. 594
26W, G24d-3
Aluminium, 594AL
Graphite, 594GR
EEI: A+..B

HELSINKI
IP 54
Powder coated
aluminium wall
light. Available in
a bent or straight
arm option.

Supplied with
clear poly-
carbonate lens.

Art. 882
77W Halo. max, E27
class II
Aluminium, 882AL
Graphite, 882GR
White, 882W
EEI: A+..D

Accessories
Art. 156
Corner bracket for
art 882.
Aluminium, 156AL
Graphite, 156GR
White, 156W

Art. 886
77W Halo. max, E27
class I
Aluminium, 886AL
Graphite, 886GR
White, 886W
EEI: A+..D

Accessories
Art. 158
Corner bracket for
art 886.
Aluminium, 158AL
Graphite, 158GR
White, 158W



NAMSOS



LED



NAMSOS MINI

NEW



LED

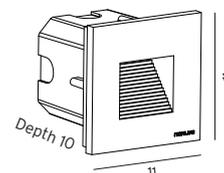
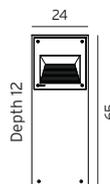
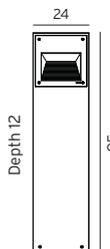
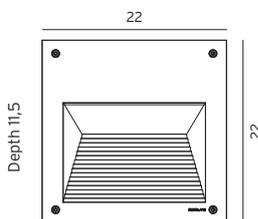

NAMSOS/NAMSOS MINI
IP 65, class I
Recessed wall lighting and bollard.
Wall fixture incl. recessing box.

Namsos Art. 1930
13,2W LED
Aluminium, 1930AL
Graphite, 1930GR
LED modul: 1376 lm, 3000K
50000h, EE: A++

Namsos Art. 1931
13,2W LED
Aluminium, 1931AL
Graphite, 1931GR
LED modul: 1376 lm, 3000K
50000h, EE: A++

Namsos Art. 1932
13,2W LED
Aluminium, 1932AL
Graphite, 1932GR
LED modul: 1376 lm, 3000K
50000h, EE: A++

Namsos Mini Art. 1340
4W LED
Aluminium, 1340AL
Graphite, 1340GR
White, 1340W
LED modul: 352 lm, 3000K
50000h, dimmable (Triac), EE: A

* Namsos wall and bollard with 4000K available by request, contact you supplier.

Accessories for 1931 and 1932

Art. 112
Concreting anchor for Art. 1931 and 1932

Art. 113
Concreting anchor for Art. 1931 and 1932

NEW!



GRIMSTAD

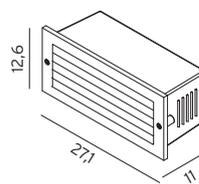
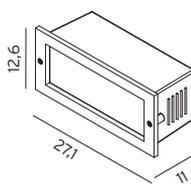
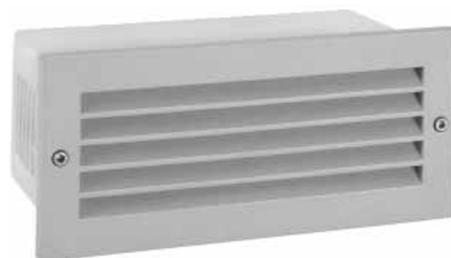
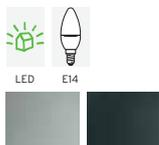

GRIMSTAD
IP 65, class I
Recessed wall lighting
fixture incl. recessing
box.

Art. 1544 
6W LED
Open frame, white
tempered safety glass.
Aluminium, 1544AL
Graphite, 1544GR
LED Module: 628 lm, 3000K,
50000h, EEI: A++

Art. 1545 
9,2W LED
Louvered frame, white
tempered safety glass.
Aluminium, 1545AL
Graphite, 1545GR
LED Module: 981 lm, 3000K,
60000h, EEI: A++

Art. 1546
46W Halo. max, E14
Aluminium, 1546AL
Graphite, 1546GR
EEI: A+..D

Art. 1547
46W Halo. max, E14
Aluminium, 1547AL
Graphite, 1547GR
EEI: A+..D





RENA



GU10 GU10 LED

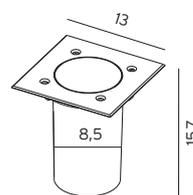
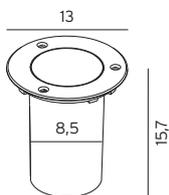

RENA

IP 68, class I
Cast aluminium inground
lighting fixture.
Tempered safety glass (max.
2000Kg), stainless steel
316L cover ring.

3m connecting cable
included. (PG in stainless
steel for cable 8-12mm)
Polypropylene box for
installation included.

Art. 1550

Round model 
5,4W LED, GU 10
Clear glass
Stainless steel, 1550ST
5,4W LED, GU10 included
402 lm, 3000K, 50000h, 40D,
EEI: A+

Art. 1552

Round model
6W max., GU 10
Clear glass
Stainless steel, 1552ST
EEI: A+..D

Art. 1554

Round model 
5,4W LED, GU 10
Frosted glass
Stainless steel, 1554ST
5,4W LED, GU10 included
402 lm, 3000K, 50000h, 40D,
EEI: A+

Art. 1556

Round model
6W max., GU 10
Frosted glass
Stainless steel, 1556ST
EEI: A+..D

Art. 1551

Square model 
5,4W LED, GU 10
Clear glass
Stainless steel, 1551ST
5,4W LED, GU10 included
402 lm, 3000K, 50000h, 40D,
EEI: A+

Art. 1553

Square model
6W max., GU 10
Clear glass
Stainless steel, 1553ST
EEI: A+..D

Art. 1555

Square model 
5,4W LED, GU 10
Frosted glass
Stainless steel, 1555ST
5,4W LED, GU10 included
402 lm, 3000K, 50000h, 40D,
EEI: A+

Art. 1557

Square model
6W max., GU 10
Frosted glass
Stainless steel, 1557ST
EEI: A+..D

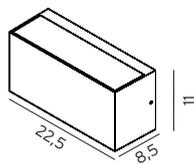

ASKER WALL

IP 65, class I.
Cast aluminium powder coated wall light.
Supplied with structure polycarbonate lens

For best light distribution we recommend version with LED or 18W.



Art. 1513

E27, 46W Halo. max.
Aluminium, 1513AL
Graphite, 1513GR
White, 1513W
Black, 1513B
EEI: A+..D



Art. 1510

8,6W LED 
Aluminium, 1510AL
Graphite, 1510GR
White, 1510W
Black, 1510B
LED Module: 800 lm,
3000K, 50000h, EEI: A+



Art. 1514

E27, 46W Halo. max.
Aluminium, 1514AL
Graphite, 1514GR
White, 1514W
Black, 1514B
EEI: A+..D



Art. 1511

8,6W LED 
Aluminium, 1511AL
Graphite, 1511GR
White, 1511W
Black, 1511B
LED Module: 800 lm,
3000K, 50000h, EEI: A+

Art. 1516

18W, G24q-2, TC-DEL
Aluminium, 1516AL
Graphite, 1516GR
White, 1516W
Black, 1516B
EEI: A+..B

Art. 1517

18W, G24q-2, TC-DEL
Aluminium, 1517AL
Graphite, 1517GR
White, 1517W
Black, 1517B
EEI: A+..B

ASKER



ASKER BOLLARD

NEW

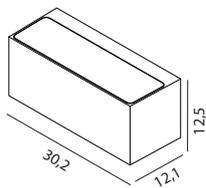

ASKER WALL (Big)
IP65, klasse I

Cast aluminium powder coated wall light. Supplied with structure polycarbonate lens

* Asker Big wall with 4000K available by request, contact you supplier.
NEW!



Art. 1300
9,3W LED
Aluminium, 1300AL
Graphite, 1300GR
White, 1300W
Black, 1300B
LED Module: 2x628 lm, 3000K, 50000h, EEI: A++

Art. 1303
E27, 46W Halo. max.
Aluminium, 1303AL
Graphite, 1303GR
White, 1303W
Black, 1303B
EEI: A+..D



Art. 1302
6W LED
Aluminium, 1302AL
Graphite, 1302GR
White, 1302W
Black, 1302B
LED Module: 628 lm, 3000K, 50000h, EEI: A++

Art. 1305
E27, 46W Halo. max.
Aluminium, 1305AL
Graphite, 1305GR
White, 1305W
Black, 1305B
EEI: A+..D

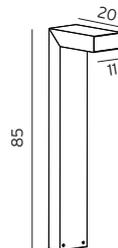

ASKER BOLLARD
IP65, klasse I

Powder coated aluminium bollard. Ideal for path-way-lighting where light pollution is an issue.
NEW!

Art. 1311
11,3W LED
Aluminium, 1311AL
Graphite, 1311GR
Black, 1311B
LED Module: 1100 lm, 3000K, 50000h, EEI: A+

Accessories for 1311 and 1312
Art. 1907
Concreting anchor

Art. 1908
Anchoring support

Art. 1312 (Dali)
11,6W LED
Aluminium, 1312AL
Graphite, 1312GR
Black, 1312B
LED Module: 1100 lm, 3000K, 50000h, EEI: A+
Dali, dimmable, 1..100% dali interface
***By request**

GENEVE

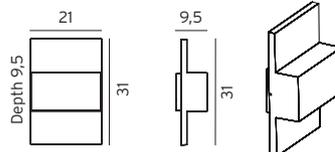

GENEVE
 IP 54, class I
 Cast aluminium powder coated
 up and down wall light, supplied
 with opal polycarbonate lens.

* For best light distribution we
 recommend version with LED

ART. 874
 E27, 46W Halo. max
 Aluminium, 874AL
 Graphite, 874GR
 White, 874W
 Black, 874B
 EEI: A+..D

Art. 879 
 8,6W LED
 Aluminium, 879AL
 Graphite, 879GR
 White, 879W
 Black, 879B
 LED Module: 800 lm,
 3000K, 50000h, EEI: A+







SANDVIK

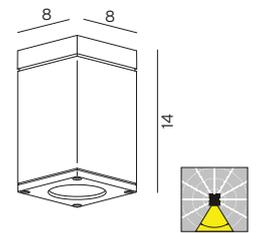
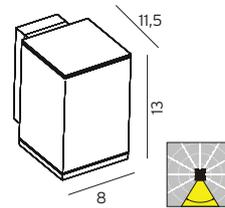
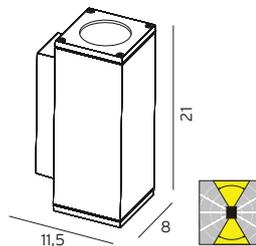

SANDVIK
class I
Powder coated aluminium.
Tempered glass.

Art. 791 and 792
Up and down wall light
IP 65

Art. 793 and 794
Down wall light
IP 65

Art. 795 and 796
Down ceiling light.
IP 54

ART. 791
2x25W max, GU 10
Aluminium, 791AL
Graphite, 791GR
White, 791W
Black, 791B
EEL: A+..D

ART. 792
2x4W, LED, GU 10 
Aluminium, 792AL
Graphite, 792GR
White, 792W
Black, 792B
2x4W LED GU10 included, 2x250 lm,
2700K, 50000h, 25D, EEL: A+

ART. 793
25W max, GU 10
Aluminium, 793AL
Graphite, 793GR
White, 793W
Black, 793B
EEL: A+..D

ART. 794
4W, LED, GU 10 
Aluminium, 794AL
Graphite, 794GR
White, 794W
Black, 794B
4W LED GU10 included, 250 lm,
2700K, 50000h, 25D, EEL: A+

ART. 795
25W max, GU 10
Aluminium, 795AL
Graphite, 795GR
White, 795W
Black, 795B
EEL: A+..D

ART. 796
4W, LED, GU 10 
Aluminium, 796AL
Graphite, 796GR
White, 796W
Black, 796B
4W LED GU10 included, 250 lm,
2700K, 50000h, 25D, EEL: A+



VASA

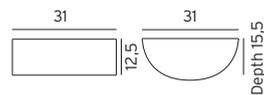

VASA IP65, class I

Powder coated cast aluminium up and down wall light. Supplied with optical structure polycarbonate lens to give even light distribution.

Art. 120
E27, 57W Halo. max
Aluminium, 120AL
Graphite, 120GR
White, 120W
Black, 120B
EEI: A+..D

Art. 126
26W, G24q-3, TC-DEL
Aluminium, 126AL
Graphite, 126GR
White, 126W
Black, 126B
EEI: A+..B

Art. 127 
E27, 8,5W
Aluminium, 127AL
Graphite, 127GR
White, 127W
Black, 127B
8,5W LED E27 included, 806 lm,
2700K, 25000h, dimmable, EEI: A+

Art. 128 
9,3W LED
Aluminium, 128AL
Graphite, 128GR
White, 128W
Black, 128B
LED Module: 2x628 lm,
3000K, 50000h, EEI: A++







HALDEN

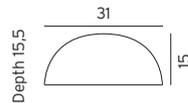

HALDEN
IP65, class I
Powder coated cast aluminium wall light. Supplied with optical structure polycarbonate lens to give even light distribution.

Available on request:
Special finish in Black Copper.

Art. 510
E27, 57W Halo. max
Aluminium, 510AL
Graphite, 510GR
White, 510W
Black, 510B
EEI: A+..D

Art. 516
18W, G24q-2, TC-DEL
Aluminium, 516AL
Graphite, 516GR
White, 516W
Black, 516B
EEI: A+..B

Art. 515 
E27, 8,5W
Aluminium, 515AL
Graphite, 515GR
White, 515W
Black, 515B
8,5W LED E27 included, 806 lm,
2700K, 25000h, dimmable, EEI: A+

Art. 517 
9,1W LED
Aluminium, 517AL
Graphite, 517GR
White, 517W
Black, 517B
LED Module: 1027 lm,
3000K, 50000h, EEI: A++

* Halden with 4000K available by request, contact you supplier.

RONDANE



BORNHOLM

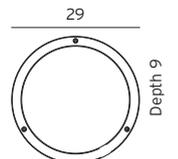
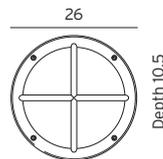

RONDANE
IP65, class I

Powder coated aluminium wall light supplied with polycarbonate lens. Rondane is suitable for wall and ceiling mounting.

RONDANE
Art. 531
18W, G24q-2, TC-DEL
Aluminium, 531AL
Graphite, 531GR
White, 531W
EE: A+..B

Art. 537
11,3W LED
Aluminium, 537AL
Graphite, 537GR
White, 537W
LED Module: 1100 lm,
3000K, 50000h, EE: A+

RONDANE
Art. 538
9W max, E27, LED
Aluminium, 538AL
Graphite, 538GR
White, 538W
EE: A+..D
Only for use with LED retrofit lamps. Not included.

BORNHOLM
IP65, class I
Powder coated aluminium wall light supplied with polycarbonate lens. Bornholm is suitable for wall and ceiling mounting.

BORNHOLM
Art. 541
11,3W LED
Aluminium, 541AL
Graphite, 541GR
White, 541W
LED Module: 1100 lm,
3000K, 50000h, EE: A+

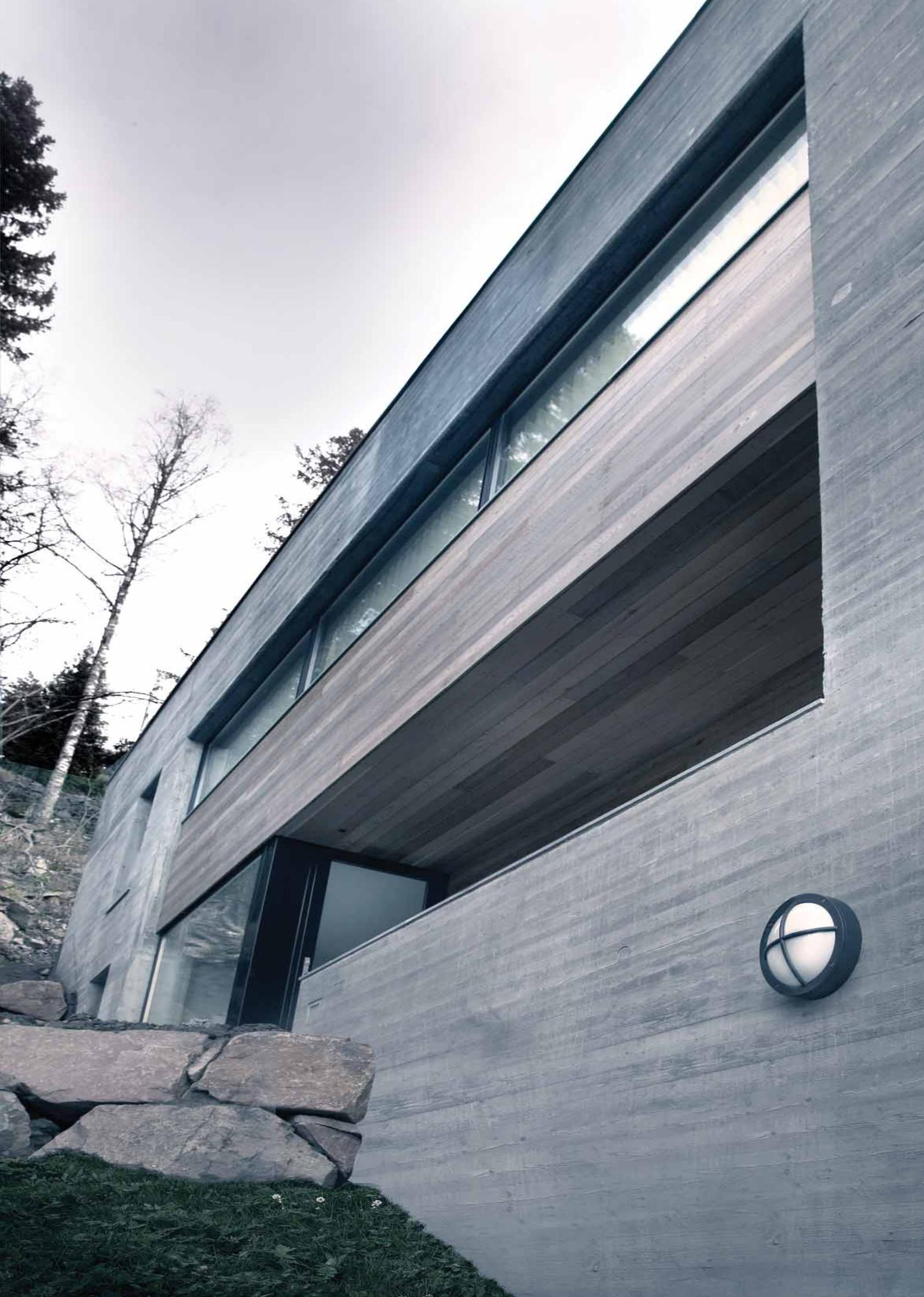



BERN



E27

LED

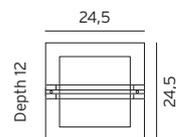

BERN IP54, class I

Wallplate in aluminium. Front in Galvanized steel, stainless steel, powder coated black steel or copper. Massive copper reveals a nice and natural patina with age. Heavy clear or frosted glass. We use stainless steel 316L. An oil application from time to time insures long time beauty of the fixture.

Art. 650
E27, 46W Halo. max
clear glass
Stainless steel, 650ST
Galvanized, 650GA
Black, 650B
EEI: A+..D

Art. 651
E27, 46W Halo. max
frosted glass
Stainless steel, 651ST
Galvanized, 651GA
Black, 651B
Copper, 651CO
EEI: A+..D

Art. 655 
6W LED
frosted glass
Stainless steel, 655ST
Galvanized, 655GA
Black, 655B
LED Module: 628 lm, 3000K
50000h, EEI: A++

Art. 656 
13W LED
frosted glass
Stainless steel, 656ST
Galvanized, 656GA
Black, 656B
LED Module: 1010 lm, 3000K





BASEL

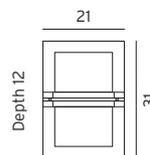

BASEL
IP54, class I

Wallplate in aluminium. Front in galvanized steel, stainless steel, powder coated black steel or copper.

Massive copper reveals a nice and natural patina with age. Heavy clear or frosted glass. We use stainless steel 316L. An oil application from time to time insures long time beauty of the fixture.

*Also available (on request) models with motion detectors.

Art. 660
E27, 57W Halo. max clear glass
Stainless steel, 660ST
Galvanized, 660GA
Black, 660B
EEI: A+.D

Art. 661 *
E27, 57W Halo. max frosted glass
Stainless steel, 661ST
Galvanized, 661GA
Black, 661B
Copper, 661CO
EEI: A+.D

Art. 668
6W LED
frosted glass
Stainless steel, 668ST
Galvanized, 668GA
Black, 668B
LED Module: 628 lm, 3000K
50000h, EEI: A++

Art. 669
13W LED
frosted glass
Stainless steel, 669ST
Galvanized, 669GA
Black, 669B
LED Module: 1010 lm, 3000K
39000h, EEI: A

BODEN

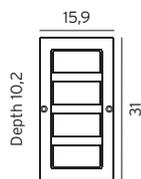
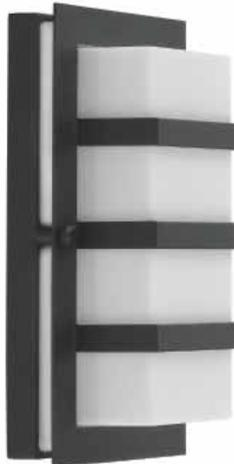

BODEN
IP54, class I.
Art. 860, 866:
Opal polycarbonate

Art. 862: Clear
polycarbonate

Art.860
E27, 46W Halo. max
Galvanized steel, 860GA
Black, 860B
EEI: A+..D

Art.862
E27, 46W Halo. max
Galvanized steel, 862GA
Black, 862B
EEI: A+..D

Art. 866 
8,6W LED
Galvanized, 866GA
Black, 866B
LED Module: 800lm, 3000K,
50000h, EEI: A+







NORDLAND



G24q-1 G24q-3 LED

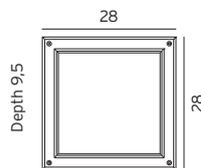

NORDLAND
IP65, class I
Powder coated aluminium
wall light supplied with
opal polycarbonate lens.

Nordland is suitable
for wall and ceiling
mounting.

Art. 713
2x13W, G24q-1, TC-DEL
Aluminium, 713AL
Graphite, 713GR
White, 713W
EEI: A+..B

Art. 714
26W, G24q-3, TC-DEL
Aluminium, 714AL
Graphite, 714GR
White, 714W
EEI: A+..B

Art. 715
2x26W, G24q-3, TC-DEL
Aluminium, 715AL
Graphite, 715GR
White, 715W
EEI: A+..B

Art. 71200
2x max 9W, E27, LED
Aluminium, 71200AL
Graphite, 71200GR
White, 71200W
EEI: A+..D
**Only for use with
LED retrofit lamps.
Not included.**

Art. 718 
11,3W LED
Aluminium, 718AL
Graphite, 718GR
White, 718W
LED Module: 1100 lm,
3000K, 50000h, EEI: A+

Art. 719 
12,9W LED
Aluminium, 719AL
Graphite, 719GR
White, 719W
LED Module: 1500lm,
3000K, 50000h, EEI: A+

Art. 5040 
13,6W LED
Aluminium, 5040AL
Graphite, 5040GR
White, 5040W
LED Module: 1500lm,
3000K, 50000h, EEI: A+

**Light engine with
integrated HF sensor
(motion, dimming,
auto off at daylight)
NEW!**

* Nordland with 4000K available by request, contact your supplier.



NORDKAPP

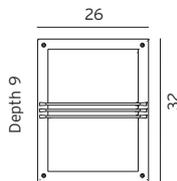

NORDKAPP
 IP65, class I
 Powder coated aluminium
 wall light supplied with
 opal polycarbonate lens.

Nordkapp is suitable
 for wall and ceiling
 mounting.

Art. 1490
 2x26W, G24q-3, TC-DEL
 Aluminium, 1490AL
 Graphite, 1490GR
 White, 1490W
 EEI: A+..B

Art. 1620 
 11,3W LED
 Aluminium, 1620AL
 Graphite, 1620GR
 White, 1620W
 LED Module: 1100 lm,
 3000K, 50000h, EEI: A+

*Nordkapp with 4000K available
 by request, contact you supplier.



OPPLAND

NEW



LED

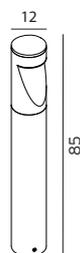

OPPLAND
IP65, Class I
Powder coated aluminium
bollard. Ideal for path-way
lighting where light
pollution is an issue.
NEW!

Art. 1321 
10,9W LED
Aluminium, 1321AL
Graphite, 1321GR
LED module: 1180 lm,
3000K, 50000h, EEI: A++

Accessories for Art. 1321

Art. 205
Concreting anchor

Art. 206
Anchoring support







MOLDE



LED

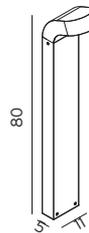

MOLDE
 IP54, classe I
 Powder coated aluminium bollard.
 Ideal for path-way-lighting where
 light pollution is an issue.

Art. 1901 
 8,6W LED
 Aluminium, 1901AL
 Graphite, 1901GR
 LED Module: 800 lm,
 3000K, 50000h, EEI: A+

Accessories
Art. 1906
 Reinforced galvanized
 metal foot for Molde

Art. 1907
 Concreting anchor
 for Molde

Art. 1908
 Anchoring support
 for Molde

SCANDINAVIAN WOOD



E27



Our new range of wooden bollards fits perfectly to all projects combining modern lighting in harmony with natural materials.

We use a selection of first class Scandinavian pine wood, impregnated for protection.

Easy maintenance: painted twice during production, refresh the surface with oil paint.

Special marked with *:

Impregnated only: without painting on request to allow customized colours.



HALMSTAD

STOCKHOLM

ALTA

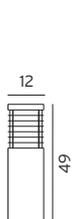

Art. 1400

E27, 46W Halo. max Galvanized, 1400GA Black, 1400B
EEI: A+



Art. 1410

E27, 46W Halo. max Galvanized, 1410GA Black 1410B
EEI: A+



Art. 1420

E27, 46W Halo. max Galvanized, 1420GA Black 1420B
EEI: A+

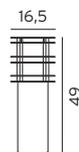

Art. 1430

E27, 46W Halo. max Galvanized, 1430GA Black 1430B
EEI: A+

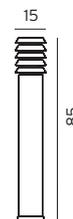

Art. 1440

E27, 46W Halo. max Galvanized, 1440GA Black 1440B
EEI: A+

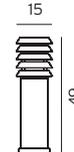

Art. 1450

E27, 46W Halo. max Galvanized, 1450GA Black 1450B
EEI: A+

Scandinavian Wood
IP65, class II

Accessories for Scandinavian wood.

Art. 205
Concreting anchor for wood series.

Art. 206
Anchoring support for wood series.

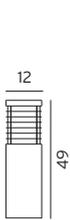
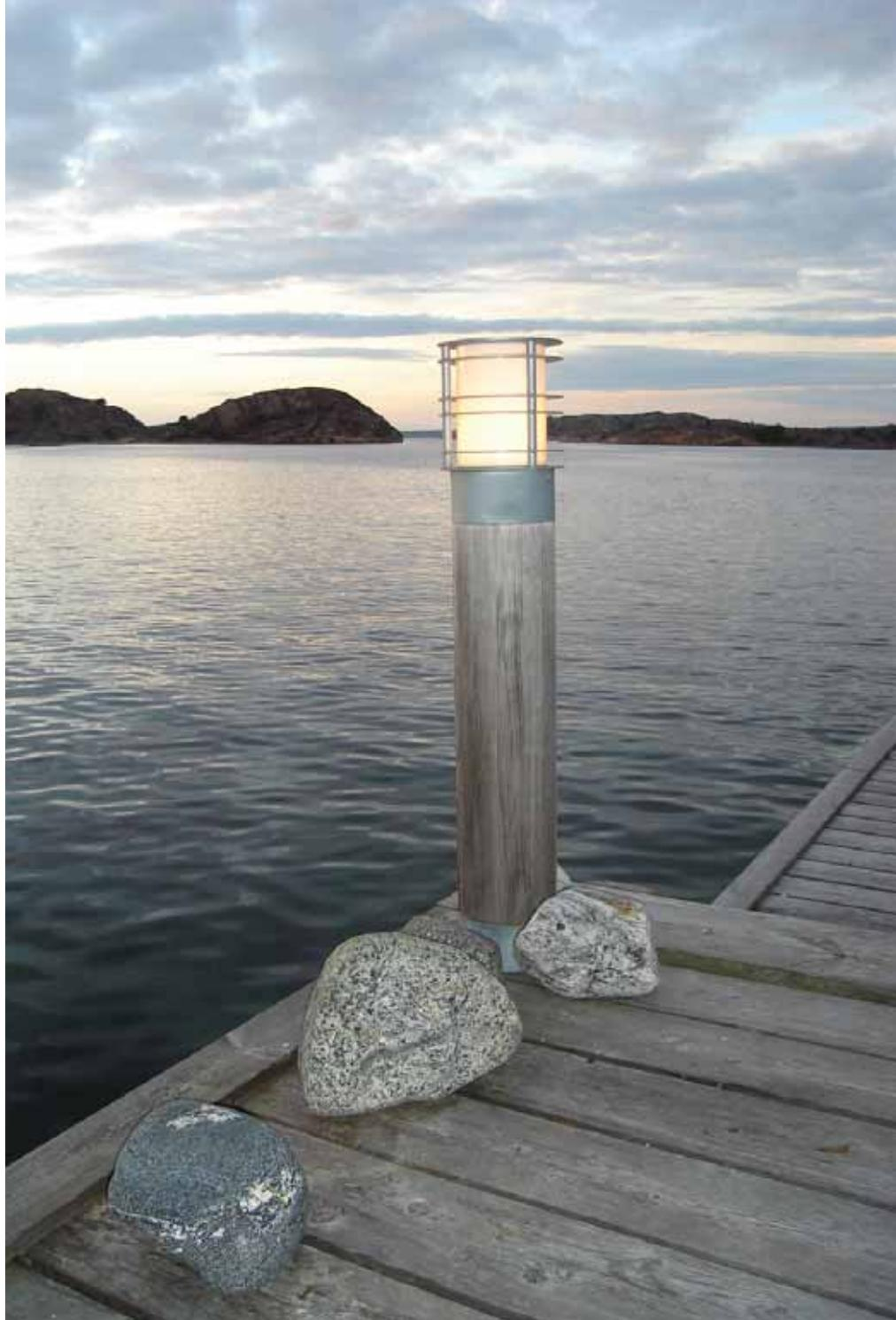

Scandinavian Wood
IP65, class II
Impregnated only.

Accessories for Scandinavian wood.

Art. 205
Concreting anchor
for wood series.

Art. 206
Anchoring support
for wood series.

Art. 1403 *
E27, 46W Halo. max
Galvanized, 1403GA
Black, 1403B
EEI: A+

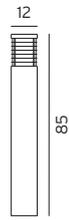

Art. 1413 *
E27, 46W Halo. max
Galvanized, 1413GA
Black, 1413B
EEI: A+

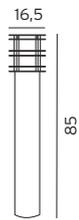

Art. 1423 *
E27, 46W Halo. max
Galvanized, 1423GA
Black, 1423B
EEI: A+

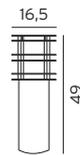

Art. 1433 *
E27, 46W Halo. max
Galvanized, 1433GA
Black, 1433B
EEI: A+

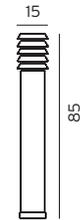

Art. 1443 *
E27, 46W Halo. max
Galvanized, 1443GA
Black, 1443B
EEI: A+

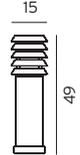

Art. 1453 *
E27, 46W Halo. max
Galvanized, 1453GA
Black, 1453B
EEI: A+

* Impregnated only; without painting on request to allow customized colours.

HALMSTAD



HALMSTAD
IP65, class II.
Bollards with LED MODULE: class I

Galvanized heavy duty steel bollard supplied with opal polycarbonate lens.

Accessories for Halmstad range
Art. 205

Concreting anchor

Art. 206
Anchoring support

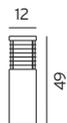

Art. 210
E27, 46W Halo. max
Galvanized, 210GA
Black, 210B
EEI: A+..d

Art. 211 
10W LED
Galvanized, 211GA
Black, 211B
LED module > 900 lm,
3000k, 50000h, EEI: A+
dimmable (Triac)

Art. 295
E27, 46W Halo. max
Galvanized, 295GA
Black, 295B
EEI: A+..d

Art. 1488 
E27, 8,5W
Galvanized, 1488GA
Black, 1488B
8,5W LED E27 included,
806 lm, 2700K, 25000h,
dimmable, EEI: A+

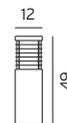

Art. 1489 
10W LED
Galvanized, 1489GA
Black 1489B
LED module > 900 lm,
3000k, 50000h, EEI: A+
dimmable (Triac)



Art. 296
E27, 46W Halo. max
Galvanized, 296GA
Black, 296B
EEI: A+..d

Art. 1483 
E27, 8,5W
Galvanized, 1483GA
Black, 1483B
8,5W LED E27 included,
806 lm, 2700K, 25000h,
dimmable, EEI: A+



Art. 1482 
10W LED
Galvanized, 1482GA
Black 1482B
LED module > 900 lm,
3000k, 50000h, EEI: A+
dimmable (Triac)

* With 4000K available by request, contact you supplier.





ALTA

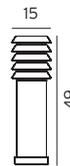
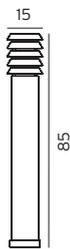

ALTA
IP65, class II

Bollards with LED MODULE: class I

Galvanized steel bollard supplied with opal polycarbonate lens.

Accessories

Art. 205
Concreting anchor for Alta range.

Art. 206
Anchoring support for Alta range.

Art. 291
E27, 46W Halo. max Galvanized, 291GA Black 291B
EEI: A+

Art. 1475
E27, 8,5W Galvanized, 1475GA Black, 1475B
8,5W LED E27 included, 806 lm, 2700K, 25000h, dimmable, EEI: A+

Art. 1479
10W LED Galvanized, 1479GA Black 1479B
LED module > 900 lm, 3000k, 50000h, EEI: A+ dimmable (Triac)

* With 4000K available by request, contact you supplier.

Art. 293
E27, 46W Halo. max Galvanized, 293GA Black 293B
EEI: A+

Art. 1477
E27, 8,5W Galvanized, 1477GA Black, 1477B
8,5W LED E27 included, 806 lm, 2700K, 25000h, dimmable, EEI: A+

Art. 1476
10W LED Galvanized, 1476GA Black 1476B
LED module > 900 lm, 3000k, 50000h, EEI: A+ dimmable (Triac)



STOCKHOLM



STOCKHOLM FAMILY →

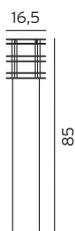

STOCKHOLM BOLLARD
Galvanized steel bollard.
IP65, class II

Bollards with LED module : class I

Accessories

Art. 205
Concreting anchor for Stockholm range.
Art. 206
Anchoring support for Stockholm range.

Art. 288
E27, 46W Halo. max, Opal
Galvanized, 288GA
Black, 288B
EEI: A+..D

Art. 297
E27, 46W Halo. max Clear
Galvanized, 297GA
Black, 297B
EEI: A+..D

Art. 1265
10W LED
Opal
Galvanized, 1265GA
Black 1265B
LED module > 900 lm, 3000k, 50000h, dimmable triac, EEI: A+
* With 4000K available by request, contact you supplier

Art. 1464
E27, 8,5W
Opal
Galvanized, 1464GA
Black, 1464B
8,5W LED E27 included, 806 lm, 2700K, 25000h, dimmable, EEI: A+

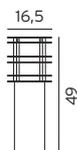

Art. 289
E27, 46W Halo. max, Opal
Galvanized, 289GA
Black, 289B
EEI: A+..D

Art. 298
E27, 46W Halo. max Clear
Galvanized, 298GA
Black, 298B
EEI: A+..D

Art. 1260
10W LED
Opal
Galvanized, 1260GA
Black 1260B
LED module > 900 lm, 3000k, 50000h, dimmable Triac, EEI: A+

Art. 1469
E27, 8,5W
Opal
Galvanized, 1469GA
Black, 1469B
8,5W LED E27 included, 806 lm, 2700K, 25000h, dimmable, EEI: A+



Art. 299
E27, 46W Halo. max, Opal
Galvanized, 299GA
Black, 299B
EEI: A+..D

Art. 1268
10W LED
Opal
Galvanized, 1268GA
Black 1268B
LED module > 900 lm, 3000k, 50000h, dimmable triac, EEI: A+







STOCKHOLM



STOCKHOLM FAMILY →

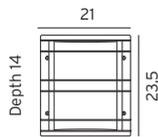

Stockholm flush
IP54, class I

Aluminium back plate. Front detail in powder coated or galvanized steel.

Art. 220, 1600
Opal polycarbonate

Art. 226 :
Clear polycarbonate

Art. 220
E27, 46W Halo. max.
Galvanized, 220GA
Black, 220B
EEI: A+..D

Art. 226
E27, 46W Halo. max
Galvanized, 226GA
Black, 226B
EEI: A+..D

Art. 1600 
8,6W LED
Galvanized, 1600GA
Black, 1600B
LED Module: 800 lm,
3000K, 50000h, EEI: A+



STOCKHOLM



E27



STOCKHOLM FAMILY →

Stockholm

IP54, class II

Supplied with clear polycarbonate lens as standard. Natural copper option will age over time.

(Opal lens available as an option).

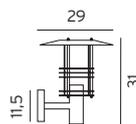

Art. 280

E27, 46W Halo. max. clear polycarbonate. Galvanized steel, 280GA
Black, 280B
White, 280W
Copper, 280CO
EEI: A+..D

Accessories

Art. 153

Corner bracket for Art. 280. Galvanized steel, 153GA
Black, 153B
White, 153W
Copper, 153CO

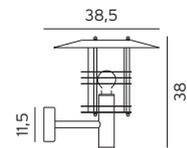

Art. 286

E27, 77W Halo. max. clear polycarbonate. Galvanized steel, 286GA
Black, 286B
White, 286W
EEI: A+..D

Accessories

Art. 153

Corner bracket for Art. 286. Galvanized steel, 153GA
Black, 153B
White, 153W



STOCKHOLM



E27

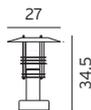

Art. 284
E27, 46W Halo. max. clear polycarbonate. Galvanized, 284GA
Black, 284B
White, 284W
EEI: A+..D

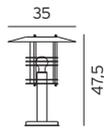

Art. 287
E27, 77W Halo. max. clear polycarbonate. Galvanized, 287GA
Black, 287B
White, 287W
EEI: A+..D



Art. 285
E27, 46W Halo. max. clear polycarbonate. Galvanized, 285GA
Black, 285B
White, 285W
EEI: A+..D

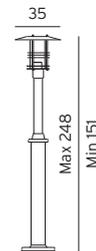

Art. 281
E27, 77W Halo. max. clear polycarbonate. Galvanized, 281GA
Black, 281B
White, 281W
EEI: A+..D

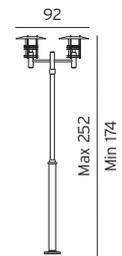

Art. 283
E27, 2x77W Halo. max. clear polycarbonate. Galvanized, 283GA
Black, 283B
White, 283W
EEI: A+..D

Stockholm
IP54, class II

Supplied with clear polycarbonate lens as standard.

Opal lens available as accessory.

Accessories

Art. 405 Concreting anchor for Art. 281 and 283.

Art. 406 Anchoring support for Art. 281 and 283.

Concreting anchor included for Art. 284, 287 and 285

Art. 284 round foot, diameter 11,5cm.

Art. 285 and 287 round foot, diameter 17cm.

Art. 281 and 283. Diameter foot 23,5 cm. The distance between bolt holes (3 bolts) for post Art. 281 and 283 is 18 cm.







BREMEN



E27 LED

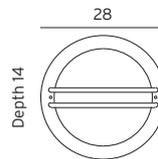
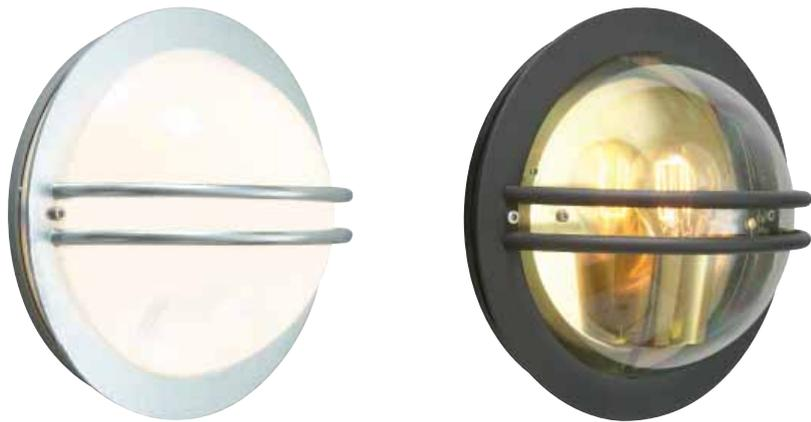

BREMEN

IP54, class I

The front cover is made of steel and mounted on an aluminium backplate.
Option of smoked or opal lens.

Available on request:
Special finish in Black
Copper.

Art. 630
E27, 46W Halo. max.
clear polycarbonate.
Galvanized, 630GA
Black, 630B
EEI: A+.D

Art. 631
E27, 46W Halo. max.
opal polycarbonate.
Galvanized, 631GA
Black, 631B
EEI: A+.D

Art. 637 
11,3W LED
opal polycarbonate.
Galvanized, 637GA
Black, 637B
LED Module: 1100 lm,
3000K, 50000h, EEI: A+

BERLIN



HAMBURG

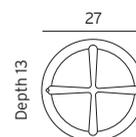
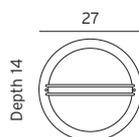

BERLIN IP54, class I

Cast aluminium wall light with clear or opal polycarbonate lens options.

Available on request:
Special finish in Black Copper.

**BERLIN
Art. 610**
E27, 46W Halo. max., clear polycarbonate.
Black, 610B
White, 610W
Aluminium, 610AL
EEI: A+..D

Art. 611
E27, 46W Halo. max., opal polycarbonate.
Black, 611B
White, 611W
Aluminium, 611AL
EEI: A+..D

**BERLIN
Art. 617**
11,3W LED
opal polycarbonate.
Black, 617B
White, 617W
Aluminium, 617AL
LED Module: 1100 lm,
3000K, 50000h, EEI: A+



HAMBURG IP54, class I

Cast aluminium wall light with clear or opal polycarbonate lens options.

Available on request:
Special finish in Black Copper.

**HAMBURG
Art. 620**
E27, 46W Halo. max., clear polycarbonate.
Black, 620B
White, 620W
Aluminium, 620AL
EEI: A+..D

Art. 621
E27, 46W Halo. max., opal polycarbonate.
Black, 621B
White, 621W
Aluminium, 621AL
EEI: A+..D





LUND



E27

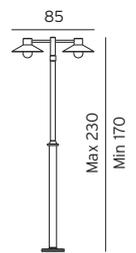
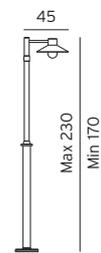
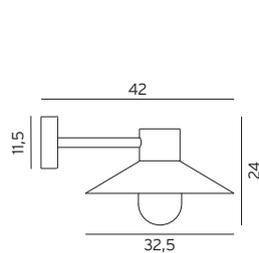
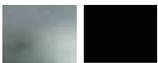

LUND
IP55, Class II,
Clear polycarbonate.

Art. 274, 275, 290
Can be ordered with
frosted glass or clear
polycarbonate as
accessories.

Art. 290
E27, 57W Halo. max.
Galvanized, 290GA
Black, 290B
EEI: A+..D

Accessories
Art. 153
Corner bracket
for Art 290.
Galvanized steel, 153GA
Black, 153B

Art. 274
E27, 57W Halo. max.,
Galvanized, 274GA
Black, 274B
EEI: A+..D

Accessories
Art. 405
Concreting anchor
for Art. 274
Art. 406
Anchoring support
for Art. 274

Art. 275
E27, 2x57W Halo. max.
Galvanized, 275GA
Black, 275B
EEI: A+..D

Accessories
Art. 405
Concreting anchor
for Art. 275
Art. 406
Anchoring support
for Art. 275



OSLO

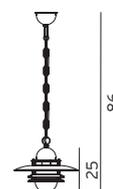
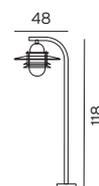
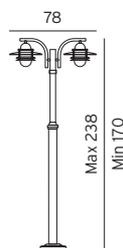
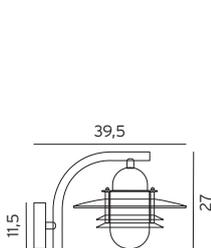
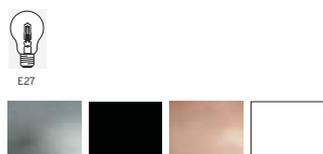

OSLO

IP55, class II
Clear polycarbonate.

All Oslo models can be ordered with frosted glass or clear polycarbonate as accessories.
The copper will age naturally over time.

Art. 240

E27, 57W Halo. max.
Galvanized, 240GA
Black, 240B
White, 240W
Copper, 240CO
EEI: A+..D

Accessories

Art. 153

Corner bracket for Art 240.
Galvanized, 153GA
Black, 153B
White, 153W
Copper, 153CO

Art. 242

E27, 2x57W Halo. max.
clear glass.
Galvanized, 242GA
Black, 242B
White, 242W
EEI: A+..D

Accessories

Art. 405

Concreting anchor for Art. 242.

Art. 406

Anchoring support for Art. 242

Art. 245

E27, 57W Halo. max.
clear glass
Galvanized, 245GA
Black, 245B
White, 245W
EEI: A+..D

Accessories

Concreting anchor included.

Art. 245 round foot, diameter 17cm.

ART. 240A (chain)

E27, 57W Halo. max.
Galvanized steel, 240A/GA
Black, 240A/B
White, 240A/W
Copper, 240A/CO
EEI: A+..D





PARIS

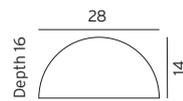
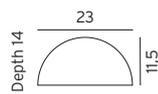

PARIS
IP43, class I

This down light gives a subtle wash of light. Over time the copper will age naturally and acquire an antique brown patina.

Art. 160
E27, 30W Halo. max.
Galvanized, 160GA
Black, 160B
White, 160W
Copper, 160CO
EEI: A+..D

Art. 163
E27, 46W Halo. max.
Galvanized, 163GA
Black, 163B
White, 163W
EEI: A+..D

Art. 1495 
6W LED
Galvanized, 1495GA
Black, 1495B
White, 1495W
LED Module: 628 lm,
3000K, 50000h, EEI: A++

Art. 1496 
6W LED
Galvanized, 1496GA
Black, 1496B
White, 1496W
LED Module: 628 lm,
3000K, 50000h, EEI: A++

KARLSTAD



E27

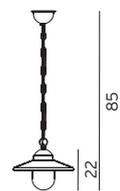
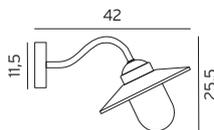

KARLSTAD

IP55, class II
Supplied with Clear polycarbonate.

All Karlstad models can be ordered with frosted glass or clear polycarbonate as accessories.
The copper will age naturally over time.

Art. 230

E27, 57W Halo. max.
Galvanized, 230GA
Black, 230B
White, 230W
Copper, 230CO
EEI: A+..D

Accessories

Art. 153

Corner bracket for Art 230.
Galvanized steel, 153GA
Black, 153B
White, 153W
Copper, 153CO

Art. 230A (chain)

E27, 57W Halo. max.
Galvanized, 230A/GA
Black, 230A/B
White, 230A/W
Copper, 230A/CO
EEI: A+..D





BERGEN



VANSBRO

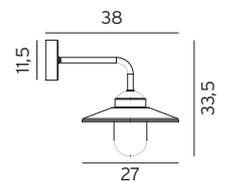
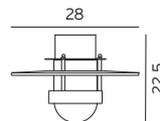
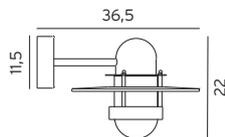

BERGEN
IP55, Class II
Supplied with clear polycarbonate lens.

Art. 270 and 271
Can be ordered with frosted glass or clear polycarbonate as accessory.

BERGEN
Art. 270
E27, 57W Halo. max.
Galvanized, 270GA
Black, 270B
White, 270W
EEI: A+..D

Accessories
Art. 153
Corner bracket for Art 270.
Galvanized steel, 153GA
Black, 153B
White, 153W

BERGEN
Art. 271
E27, 57W Halo. max.
Galvanized, 271GA
Black, 271B
White, 271W
EEI: A+..D

VANSBRO
IP55, class II
Supplied with clear polycarbonate lens.

The copper will age naturally over time.

VANSBRO
Art. 1920
E27, 57W Halo. max.
Galvanized, 1920GA
Black, 1920B
White, 1920W
Copper, 1920CO
EEI: A+..D

Accessories
Art. 153
Corner bracket for Art 1920.
Galvanized steel, 153GA
Black, 153B
White, 153W
Copper, 153CO





CHELSEA



E27



CHELSEA FAMILY →

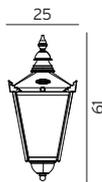

Art. 950
E27, 77W Halo. max.
Copper, 950CO
EEI: A+..D

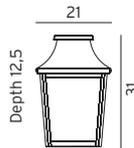

Art. 962
E27, 57W Halo. max.
Copper, 962CO
EEI: A+..D

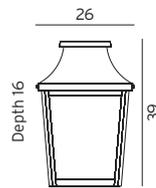

Art. 963
E27, 57W Halo. max.
Copper, 963CO
EEI: A+..D

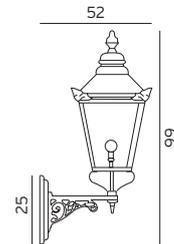

Art. 955
E27, 77W Halo. max.
Copper, 955CO
EEI: A+..D

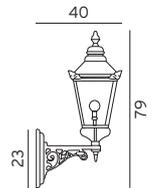

Art. 954
E27, 77W Halo. max.
Copper, 954CO
EEI: A+..D

CHELSEA RANGE

IP44, class II
Fabricated from copper and supplied with clear polycarbonate lens.

Copper fittings are supplied in a raw finish to allow natural patina over time.

Brackets and posts manufactured in aluminium and powder coated in black.

Accessories

Art. 152
Corner bracket for Art. 954.
Black, 152B

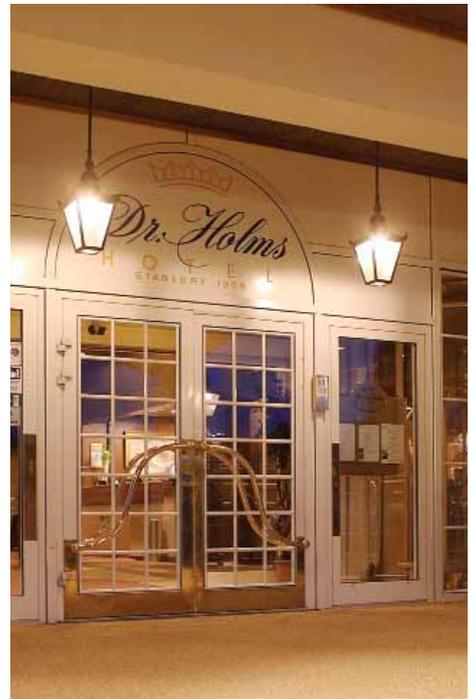

CHELSEA

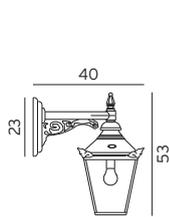

Art. 960
E27, 77W Halo. max.
Copper, 960CO
EEI: A+.D

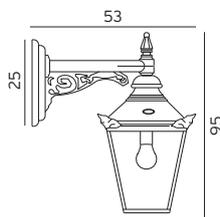

Art. 964
E27, 77W Halo. max.
Copper, 964CO
EEI: A+.D
NEW!

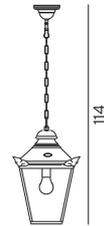

Art. 961
E27, 77W Halo. max.
Copper, 961CO
EEI: A+.D



Art. 956
E27, 77W Halo. max.
Copper, 956CO
EEI: A+.D



Art. 957
E27, 77W Halo. max.
Copper, 957CO
EEI: A+.D

CHELSEA RANGE
IP44, class II
Fabricated from copper and supplied with clear polycarbonate lens.
Copper fittings are supplied in a raw finish to allow natural patina over time.
Brackets and posts manufactured in aluminium and powder coated in black.

Accessories
Art. 152
Corner bracket for Art 960.

Black, 152B

Accessories
Art. 307
Concreting anchor for Art. 956

Accessories
Art. 307
Concreting anchor for Art. 957

CHELSEA



E27



Art. 951
E27, 77W Halo. max.
Copper, 951CO
EEI: A+..D

- Accessories**
Art. 305
Concreting anchor for Art. 951
Art. 306
Anchoring support for Art. 951

Hexagonal foot. 3 holes for anchoring. Distance between holes: 20,5 cm.



Art. 953
E27, 2x77W Halo. max.
Copper, 953CO
EEI: A+..D

- Accessories**
Art. 305
Concreting anchor for Art. 953
Art. 306
Anchoring support for Art. 953

Hexagonal foot. 3 holes for anchoring. Distance between holes: 20,5 cm.

GENOVA MINI



E27



GENOVA



E27



VENEDIG



E27



GENOVA MINI
Art. 175

E27, 46W Halo. max.
IP 54, class II,
clear polycarbonate.

Black, 175B
White, 175W
EEI: A+..D

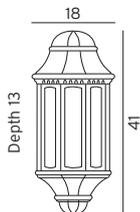

GENOVA
Art. 170

E27, 46W Halo. max.
IP54, class II,
clear polycarbonate.

Black, 170B
White, 170W
EEI: A+..D

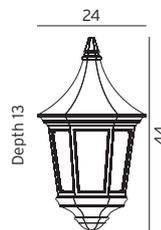

VENEDIG
Art. 261

E27, 46W Halo. max.
IP54, class II,
clear polycarbonate.

Black, 261B
White, 261W
EEI: A+..D





GLASGOW



LATINA



ROMA

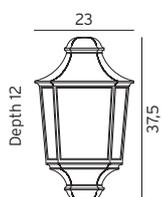

GLASGOW
Art. 730
 E27, 46W Halo. max.
 IP54, class II,
 clear polycarbonate.

Black, 730B
 White, 730W
 EEI: A+..D

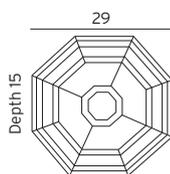

LATINA
Art. 105
 E27, 46W Halo. max.
 IP44, class II,
 frosted polycarbonate.

Black, 105B
 White, 105W
 EEI: A+..D

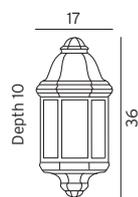

ROMA
Art. 169
 E27, 46W Halo. max.
 IP54, class II,
 clear polycarbonate.

Black, 169B
 White, 169W
 EEI: A+..D

LOFOTEN

NEW



E27

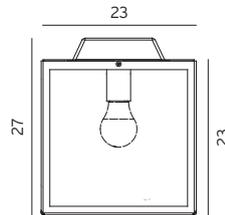
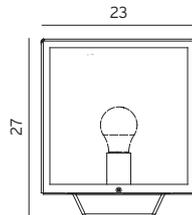
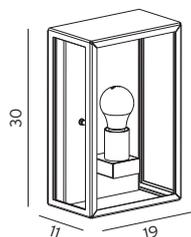

LOFOTEN
IP44, classe II

Classic outdoor wall, pedestal or ceiling fixture with clear glass.

Art. 1940
Wall
E27, 57W Halo. max.
Black, 1940B
EEI: A+..D

Art. 1941
Pedestal
E27, 57W Halo. max.
Black, 1941B
EEI: A+..D
NEW!

Art. 1942
Ceiling
E27, 57W Halo. max.
Black, 1942B
EEI: A+..D
NEW!



LONDON



E27



LONDON FAMILY →

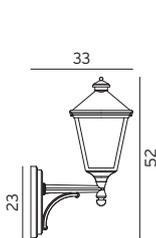

Art. 480
E27, 77W Halo. max.
Black, 480B
White, 480W
EEI: A+.D

Accessories
Art. 152
Corner bracket for
Art. 480.
Black, 152B
White, 152W

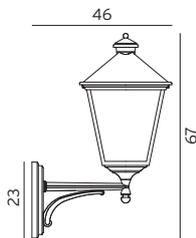

Art. 490
E27, 77W Halo. max.
Black, 490B
White, 490W
EEI: A+.D

Accessories
Art. 152
Corner bracket for
Art. 490.
Black, 152B
White, 152W

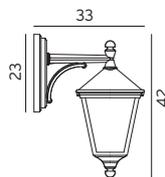

Art. 481
E27, 77W Halo. max.
Black, 481B
White, 481W
EEI: A+.D

Accessories
Art. 152
Corner bracket for
Art. 481.
Black, 152B
White, 152W

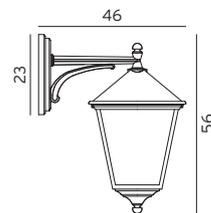

Art. 493
E27, 77W Halo. max.
Black, 493B
White, 493W
EEI: A+.D

Accessories
Art. 152
Corner bracket for
Art. 493.
Black, 152B
White, 152W

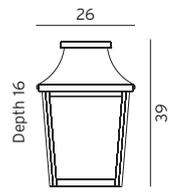

Art. 497
E27, 57W Halo. max.
Black, 497B
White, 497W
EEI: A+.D



ART. 490



LONDON



LONDON FAMILY →



Art. 484
E27, 77W Halo. max.
Black, 484B
White, 484W
EEI: A+..D

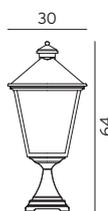

Art. 494
E27, 77W Halo. max.
Black, 494B
White, 494W
EEI: A+..D



Art. 485
E27, 77W Halo. max.
Black, 485B
White, 485W
EEI: A+..D



Art. 481A
E27, 77W Halo. max.
Black, 481A/B
White, 481A/W
EEI: A+..D



Art. 493A
E27, 77W Halo. max.
Black, 493A/B
White, 493A/W
EEI: A+..D

All London range.
IP54, class II.
Supplied with lightly tinted polycarbonate lens

Art. 484 and 485
square base- 16,5 cm. Distance between the two holes 9 cm.
Art. 494
square base- 20 cm. Distance between the two holes 9 cm.

Accessories

Art. 307
Concreting anchor for Art. 484

Accessories

Art. 307
Concreting anchor for Art. 494.

Accessories

Art. 307
Concreting anchor for Art. 485.

LONDON



E27

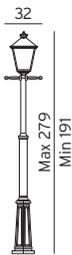

Art. 491
E27, 77W Halo. max.
Black, 491B
White, 491W
EEI: A+..D

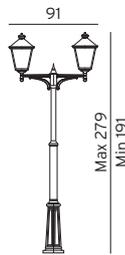

Art. 492
E27, 2x77W Halo. max.
Black, 492B
White, 492W
EEI: A+..D

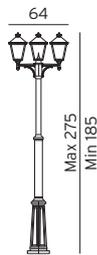

Art. 483
E27, 3x77W Halo. max.
Black, 483B
White, 483W
EEI: A+..D

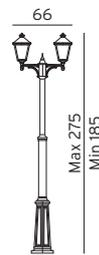

Art. 482
E27, 2x77W Halo. max.
Black, 482B
White, 482W
EEI: A+..D



Art. 495
E27, 3x77W Halo. max.
Black, 495B
White, 495W
EEI: A+..D

All London range.
IP54, class II.
Supplied with lightly tinted polycarbonate lens.
Hexagonal foot. Distance between the three holes is 20,5 cm.

Accessories London Range

Art. 305

Concreting anchor for Art. 482, 483, 491, 492 and 495

Art. 306

Anchoring support for Art. 482, 483, 491, 492 and 495





MODENA



E27



MODENA FAMILY →

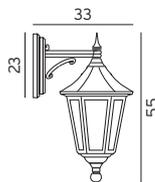

Art. 351
E27, 77W Halo. max.
Black, 351B
White, 351W
EEI: A+..D

Accessories
Art. 152
Corner bracket for
Art. 351.
Black, 152B
White, 152W

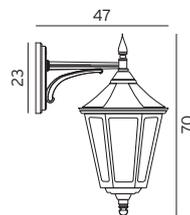

Art. 381
E27, 77W Halo. max.
Black, 381B
White, 381W
EEI: A+..D

Accessories
Art. 152
Corner bracket for
Art. 381.
Black, 152B
White, 152W



Art. 350
E27, 77W Halo. max.
Black, 350B
White, 350W
EEI: A+..D

Accessories
Art. 152
Corner bracket for
Art. 350.
Black, 152B
White, 152W

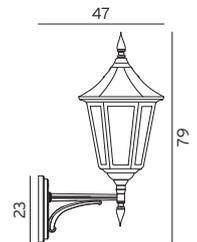

Art. 380
E27, 77W Halo. max.
Black, 380B
White, 380W
EEI: A+..D

Accessories
Art. 152
Corner bracket for
Art. 380.
Black, 152B
White, 152W







MODENA



E27



MODENA FAMILY →

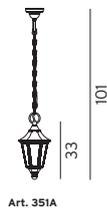

Art. 351A

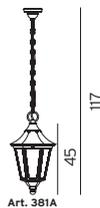

Art. 381A



Art. 300
E27, 77W Halo. max.
Black, 300B
White, 300W
EEI: A+..D

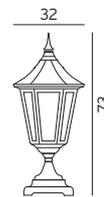

Art. 384
E27, 77W Halo. max.
Black, 384B
White, 384W
EEI: A+..D



Art. 304
E27, 77W Halo. max.
Black, 304B
White, 304W
EEI: A+..D

All Modena range.
IP 54, class II.
Supplied with lightly tinted polycarbonate lens

Art. 381A BIG (chain)
E27, 77W Halo. max.
Black, 381A/B
White, 381A/W
EEI: A+..D

Accessories
Art. 307
Concreting anchor
for Art. 300

Accessories
Art. 307
Concreting anchor
for Art. 384

Accessories
Art. 307
Concreting anchor
for Art. 304

MODENA



E27



Art. 301
E27, 77W Halo. max.
Black, 301B
White, 301W
EEI: A+..D

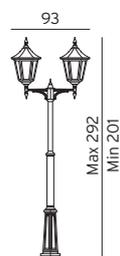

Art. 382
E27, 2x77W Halo. max.
Black, 382B
White, 382W
EEI: A+..D

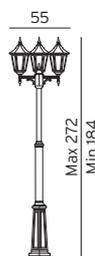

Art. 303
E27, 3x77W Halo. max.
Black, 303B
White, 303W
EEI: A+..D

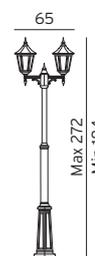

Art. 302
E27, 2x77W Halo. max.
Black, 302B
White, 302W
EEI: A+..D

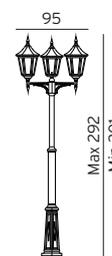

Art. 397
E27, 3x77W Halo. max.
Black, 397B
White, 397W
EEI: A+..D

All Modena range.
IP 54, class II.
Supplied with lightly tinted polycarbonate lens

Accessories for Modena

Art. 305

Concreting anchor for Art. 301, 302, 303, 382 and 397

Art. 306

Anchoring support for Art. 301, 302, 303, 382 and 397



BOLOGNA



E27

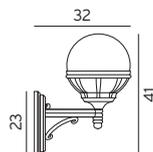

Art. 360
tinted globe.
E27, 46W Halo max.
Black, 360B
White, 360W
EEI: A+..D

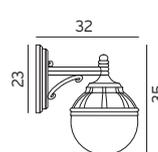

Art. 310
tinted globe.
E27, 46W Halo max.
Black, 310B
White, 310W
EEI: A+..D



Art. 310A
tinted globe.
E27, 46W Halo max.
Black, 310A/B
White, 310A/W
EEI: A+..D

Bologna range.
Globe: Clear tinted polycarbonate
or opal polycarbonate globe.
Class II, IP54.

Accessories

Art. 152

Corner bracket for
Art. 360, 361, 310 and 311
Black, 152B
White, 152W

Art. 361
opal globe.
E27, 46W Halo max.
Black, 361B
White, 361W
EEI: A+..D

Art. 311
opal globe.
E27, 46W Halo max.
Black, 311B
White, 311W
EEI: A+..D

Art. 311A,
opal globe.
E27, 46W Halo max.
Black, 311A/B
White, 311A/W
EEI: A+..D



BOLOGNA



E27

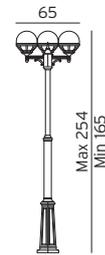
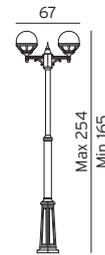
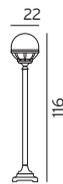

Bologna range.
Globe: Clear tinted polycarbonate
or opal polycarbonate globe.
Class II, IP54.

Accessories

Art. 305, Concreting anchor
for Art. 362, 363, 364 and 365.

Art. 306, Anchoring support
for Art. 362, 363, 364 and 365.

Art. 307
Concreting anchor for
Art. 312, 313, 314 and 315.

Art.312
tinted globe.
E27, 46W Halo max.
Black, 312B
White, 312W
EEI: A+..D

Art.313,
opal globe.
E27, 46W Halo max.
Black, 313B
White, 313W
EEI: A+..D

Art. 314
tinted globe.
E27, 46W Halo max.
Black, 314B
White, 314W
EEI: A+..D

Art. 315
opal globe.
E27, 46W Halo max.
Black, 315B
White, 315W
EEI: A+..D

Art. 362,
tinted globe.
E27, 2x46W Halo max.
Black, 362B
White, 362W
EEI: A+..D

Art. 363,
opal globe.
E27, 2x46W Halo max.
Black, 363B
White, 363W
EEI: A+..D

Art. 364
tinted globe.
E27, 3x46W Halo max.
Black, 364B
White, 364W
EEI: A+..D

Art. 365
opal globe.
E27, 3x46W Halo max.
Black, 365B
White, 365W
EEI: A+..D

Art. 362, 363, 364 and 365 Hexagonal foot. 3 holes for anchoring. Distance between holes: 20,5 cm. (three bolts).
Art. 312, 313, 314 and 315 has a square feet 16,5 cm. Distance between the two bolt holes is 9 cm.

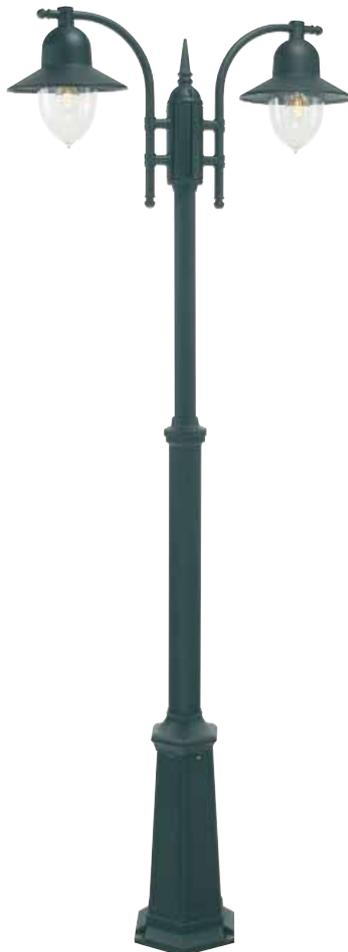

COMO

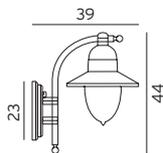

Art. 370
E27, 57W Halo. max.
Black, 370B
White, 370W
EEI: A+..D

Accessories
Art. 152
Corner bracket for
Art. 370.
Black, 152B
White, 152W

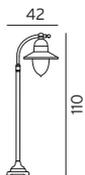

Art. 375
E27, 57W Halo. max.
Black, 375B
White, 375W
EEI: A+..D

Accessories
Art. 307
Concreting anchor
for Art. 375

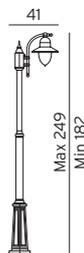

Art. 371
E27, 57W Halo. max.
Black, 371B
White, 371W
EEI: A+..D

Accessories
Art. 305
Concreting anchor for
Art. 371
Art. 306
Anchoring support for
Art. 371

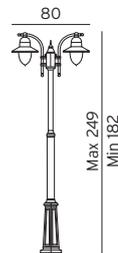

Art. 372
E27, 2x57W Halo. max.
Black, 372B
White, 372W
EEI: A+..D

Accessories
Art. 305
Concreting anchor for
Art. 372
Art. 306
Anchoring support for
Art. 372



Art. 373
E27, 3x57W Halo. max.
Black, 373B
White, 373W
EEI: A+..D

Accessories
Art. 305
Concreting anchor for
Art. 373
Art. 306
Anchoring support for
Art. 373

All Como range.
IP54, class II.
Lightly tinted polycarbonate.
Opal polycarbonate on request.

Art. 371, 372 og 373: Hexagonal foot. Distance between the three holes is 20,5 cm.
Art. 375: Square base- 16,5 cm. Distance between the two holes 9 cm.



FIRENZE



E27



Art. 800A
E27, 57W Halo. max.
Black, 800A/B
White, 800A/W
EEI: A+..D

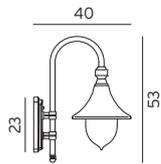

Art. 800
E27, 57W Halo. max.
Black, 800B
White, 800W
EEI: A+..D

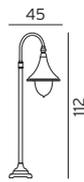

Art. 805
E27, 57W Halo. max.
Black, 805B
White, 805W
EEI: A+..D

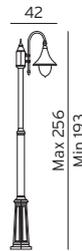

Art. 810
E27, 57W Halo. max.
Black, 810B
White, 810W
EEI: A+..D

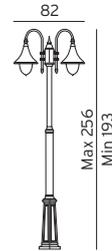

Art. 820
E27, 2x57W Halo. max.
Black, 820B
White, 820W
EEI: A+..D

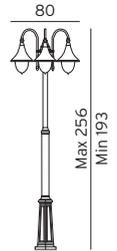

Art. 830
E27, 3x57W Halo. max.
Black, 830B
White, 830W
EEI: A+..D

All Firenze range.
IP54, class II.
Lightly tinted
polycarbonate.
Opal polycarbonate
on request.

Accessories
Art. 152
Corner bracket for
Art. 800
Black, 152B
White, 152W

Accessories
Art. 307
Concreting anchor
for Art. 805

Accessories
Art. 305
Concreting anchor for Art. 810, 820 and 830
Art. 306
Anchoring support for Art. 810, 820 and 830

Art. 810, 811, 820: Hexagonal foot. Distance between the three holes is 20,5 cm.
Art. 805: Square base- 16,5 cm. Distance between the two holes 9 cm.



R I M I N I /
M I L A N O



E27

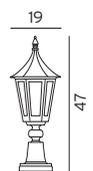
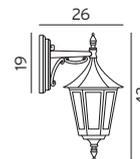
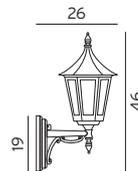

Concerns Rimini/ Milano range.
Glass: clear polycarbonate lens.
Class II, IP 54.

Rimini range contains of art.
259, 2591, 250, 402, 403 and 404.

Milano range contains of art. 401

Art. 259
E27, 46W Halo max.
Black, 259B
White, 259W
EEI: A+..D

Accessories
Art. 150
Corner bracket for
Art. 259 and 2591

Black, 150B
White, 150W

Art. 2591
E27, 46W Halo max.
Black, 2591B
White, 2591W
EEI: A+..D

Accessories
Art. 150
Corner bracket for
Art. 259 and 2591

Black, 150B
White, 150W

Art. 250
E27, 46W Halo max.
Black, 250B
White, 250W
EEI: A+..D

Accessories
Art. 307
Concreting anchor
for Art. 250 and
404.

RIMINI / MILANO



E27

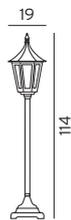

Art. 404
E27, 46W Halo max.
Black, 404B
White, 404W
EEI: A+..D

Accessories
Art. 307
Concreting anchor
for Art. 250 and
404.

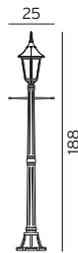

Art. 401
E27, 77W Halo max.
Black, 401B
White, 401W
EEI: A+..D

Accessories
Art. 405
Concreting anchor
for Art.401
Art. 406
Anchoring support
for Art. 401

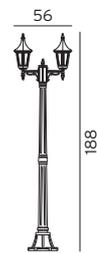

Art. 402
E27, 2x46W Halo max.
Black, 402B
White, 402W
EEI: A+..D

Accessories
Art. 405
Concreting anchor for
Art.402
Art. 406
Anchoring support
for Art. 402

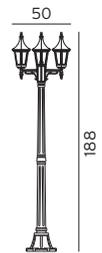

Art. 403
E27, 3x46W Halo max.
Black, 403B
White, 403W
EEI: A+..D

Accessories
Art. 405
Concreting anchor
for Art.403
Art. 406
Anchoring support for
Art. 403

Rimini/ Milano range.
Glass: clear polycarbonate lens.
Class II, IP 54.

Rimini range contains of art. 259,
259I, 250, 402, 403 og 404.

Milano range contains of art. 401

ACCESSORIES FOR NORLYS LAMPS

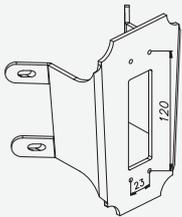

Art. 150
Corner bracket
Rimini



Art. 152
Corner bracket
Chelsea
Bologna
London
Modena
Como
Firenze

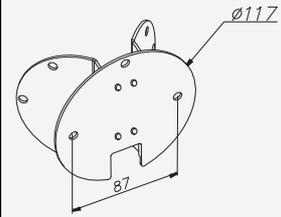

Art. 153
Corner bracket
Stockholm
Oslo
Lund
Bergen
Karlstad
Vansbro

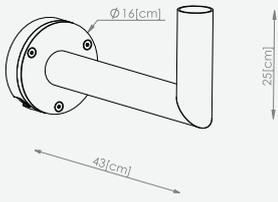

Art. 154
Arm for
Visby
Nice

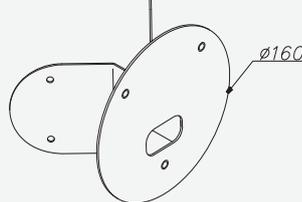

Art. 156
Corner bracket
Helsinki
(Only 880, 882,
883)

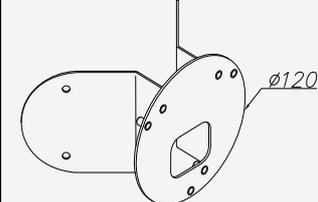

Art. 158
Corner bracket
Helsinki
Koster

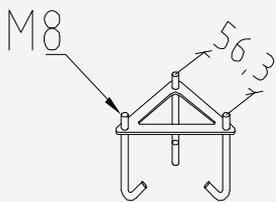

Art. 205
Concreting anchor
Halmstad bollard
Stockholm bollard
Alta Bollard
Scandinavian wood
Egersund Mini
Oppland

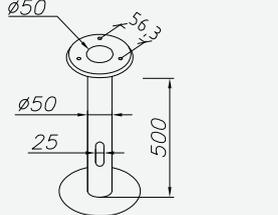

Art. 206
Anchoring support
Halmstad bollard
Stockholm bollard
Alta Bollard
Scandinavian wood
Egersund Mini
Oppland

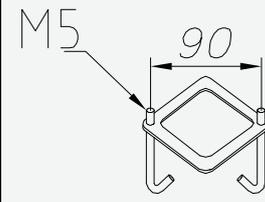

Art. 307
Concreting anchor
Chelsea
Bologna
London
Modena
Como
Firenze

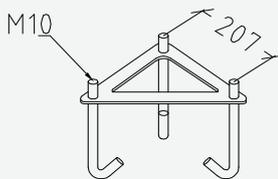

Art. 305
Concreting anchor
Chelsea
Bologna
London
Modena
Como
Firenze

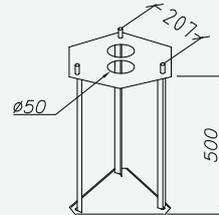

Art. 306
Anchoring support
Chelsea
Bologna
London
Modena
Como
Firenze

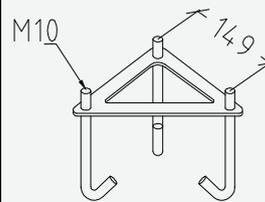

Art. 505
Concreting anchor
Narvik

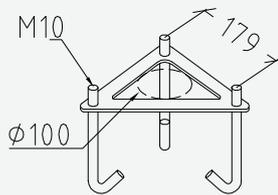

Art. 405
Concreting anchor
Stockholm
Oslo
Lund
Rimini/Milano
Koster
Helsinki

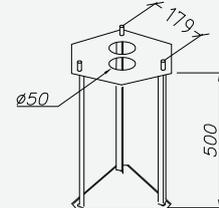

Art. 406
Anchoring support
Stockholm
Oslo
Lund
Rimini/Milano
Koster
Helsinki

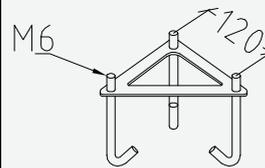

Art. 1128
Concreting anchor
Oslo 245
Arvika 890-897
Stockholm 285, 287

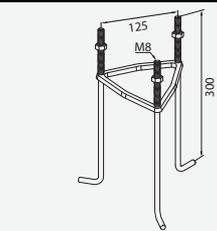

Art. 1230
Concreting anchor
Stavanger
Egersund

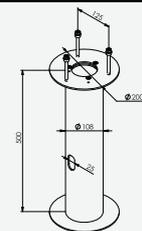

Art. 1231
Anchoring support
Stavanger
Egersund

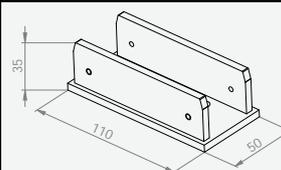

Art. 1906
Reinforced galvanized
metal foot for Molde

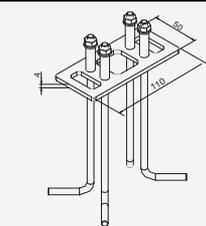

Art. 1907
Concreting anchor
Molde
Asker

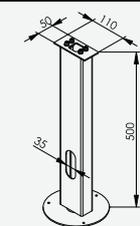

Art. 1908
Anchoring support
Molde
Asker

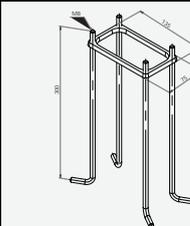

Art. 112
Concreting anchor
Namsos

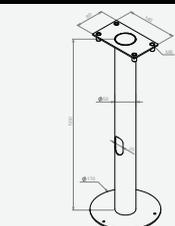

Art. 113
Anchoring support
Namsos

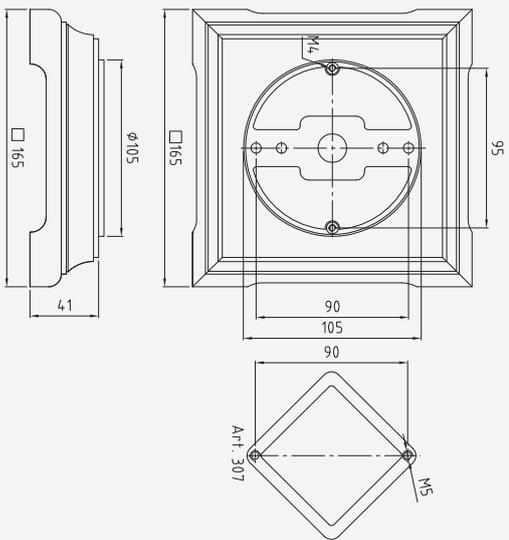

Dimensions of base art.

Bologna	312
Bologna	313
Bologna	314
Bologna	315
Chelsea	956
Chelsea	957
Como	375
Firenze	805
London	484
London	485
Modena	300
Modena	304

(165mm)

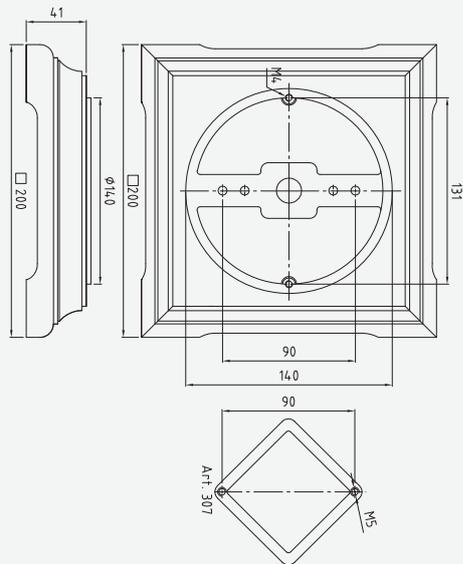

Dimensions of base art.

London	494
Modena	384

(200mm)

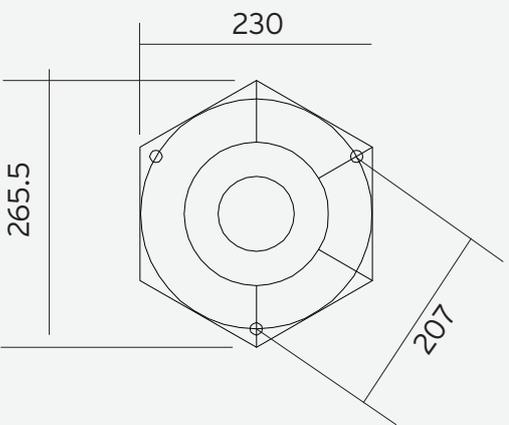

Dimensions of base art.

Bologna	362
Bologna	363
Bologna	364
Bologna	365
Chelsea	951
Chelsea	953
Como	371
Como	372
Como	373
Firenze	810
Firenze	820
Firenze	830
London	482
London	483
London	491
London	492
Mondena	301
Mondena	302
Mondena	303
Mondena	382

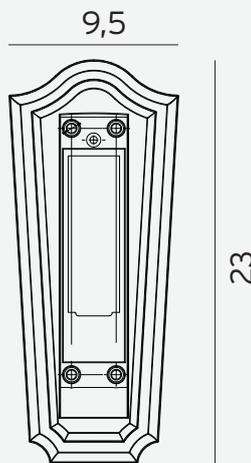

Dimensions of wall bracket

Bologna	310
Bologna	311
Bologna	360
Bologna	361
Chelsea	954
Chelsea	960
Como	370
Firenze	800
London	480
London	481
London	490
London	493
Modena	350
Modena	351
Modena	380
Modena	381

Norlys AS
P.B 1014 Hoff, 0218 Oslo
Hovfaret 4B, 0275 Oslo
Norway
Tel. +47 24 12 40 10
Fax. +47 24 12 40 11
www.norlys.com
E-mail: firmapost@norlys.no