

20
LIGHTING COLLECTION
20



C. CANGINI & TUCCI®

20
LIGHTING COLLECTION
20

 . CANGINI & TUCCI®



QUALITÀ MADE IN ITALY

QUALITY MADE IN ITALY / QUALITÄT IN ITALIEN GEMACHT

TUTTI I NOSTRI PRODOTTI SONO ACCOMPAGNATI DA UN CERTIFICATO DI GARANZIA CHE NE ATTESTA L'ORIGINALITÀ, LA MANIFATTURA ITALIANA E LA QUALITÀ. I NOSTRI PRODOTTI SONO FRUTTO DELLA PIÙ PURA PRODUZIONE ARTIGIANALE E, DI CONSEGUENZA, ALCUNE IMPERFEZIONI DEL CRISTALLO, DEL COLORE, DEL CAMBIO DI TONALITÀ, NON VENGONO CONSIDERATI DIFETTI MA PREGI, CHE NE GARANTISCONO L'AUTENTICITÀ RENDENDO IL PEZZO UNICO.

ALL OUR PRODUCTS ARE PROVIDED OF A WARRANTY CERTIFICATE THAT AUTHENTICATES THE ORIGINALITY, THE ITALIAN MANUFACTURING AND QUALITY OF THE PRODUCT. WE GUARANTEE THAT OUR PRODUCTS ARE THE RESULT OF THE PUREST HANDMADE PRODUCTION, AND FOR THIS REASON ANY IMPERFECTIONS IN THE CRYSTAL OR COLOUR (OR CHANGES OF TONALITY) ARE NOT DEFECTIVE. EACH HAS PARTICULAR FEATURES THAT GUARANTEE THEIR AUTHENTICITY AND OFFER OUR ESTEEMED CUSTOMERS A OPPORTUNITY TO OWN A UNIQUE PRODUCT TO TREASURE.

ALLE UNSERE PRODUKTE WERDEN VON EINER GARANTIE BEGLEITET, DIE DEREN ORIGINALITÄT, DIE ITALIENISCHE HANDARBEIT UND DIE QUALITÄT BESCHIEINIGEN. UNSERE PRODUKTE SIND DAS ERGEBNIS REINSTER HANDWERKLICHER PRODUKTION UND FOLGLICH SIND EINIGE UNVOLLKOMMENHEITEN DES KRISTALLS, DER FARBE, DER NUANCENÄNDERUNG NICHT ALS FEHLER, SONDERN ALS WERT ZU ERACHTEN, DER DIE AUTHENTIZITÄT DES PRODUKTS GEWÄHRLEISTET UND ES EINZIGARTIG MACHT.



LINEE DI LUCE

LINES OF LIGHT / LICHTLINIEN



“SEGN E LINEE PRENDONO FORMA
TRA FUOCO E MATERIA.
LA LUCE SI DESCRIVE NELL'IRREGOLARITÀ
DEL VETRO CREANDO TENUI OMBRE ED ESALTANDO
TUTTA LA SAPIENZA DI GESTI ANTICHI,
DOVE L'UNICITÀ DELLA FORMA SI SPOSA AL DESIGN.
QUESTO È IL NOSTRO MODO DI INTERPRETARE E
RENDERE VIVA LA LUCE”.

“SIGNS AND LINES TAKE SHAPE
FROM FIRE AND RAW MATERIALS.
THE LIGHT IS DESCRIBED IN THE IRREGULARITY
OF THE GLASS CREATING SOFT SHADOWS
AND ENHANCING ALL THE WISDOM OF ANCIENT
GESTURES, WHERE THE UNIQUENESS
OF THE FORM IS COMBINED WITH DESIGN.
THIS IS OUR INTERPRETATION OF BRINGING
LIGHT TO LIFE”.

“ZEICHEN UND LINIEN NEHMEN ZWISCHEN FEUER
UND MATERIE FORM AN. DAS LICHT BRICHT SICH
IN DER UNREGELMÄSSIGKEIT DES GLASES, ERZEUGT
ZARTE SCHATTEN UND HEBT DIE WEISHEIT ANTIKER
GESTEN HERVOR, WOBEI DIE EINZIGARTIGKEIT
DER FORM MIT DEM DESIGN KOMBINIERT WIRD.
DIES IST UNSERE ART, LICHT ZU INTERPRETIEREN
UND ZUM LEBEN ZU ERWECKEN”.





METALLIZ- ZAZIONE

METALLIZATION / METALLISIERUNG

IL PROCESSO DI METALLIZZAZIONE VIENE ESEGUITO CON METODO ARTIGIANALE. PICCOLE IMPERFEZIONI PIÙ O MENO EVIDENTI SONO INEVITABILI E NE ATTESTANO VALORIZZANDONE L'ESECUZIONE MANUALE DELLA STESSA. IL PROCESSO NON UTILIZZANDO CODICI RAL PUÒ DARE LUOGO A DIFFERENTI TONALITÀ DI COLORE CHE POSSONO CAMBIARE DA UNA FASE DI LAVORAZIONE ALL'ALTRA A DISTANZA DI TEMPO. L'AZIENDA RISERVA E GARANTISCE UN ATTENTO CONTROLLO DI QUALITÀ.

THE METALLIZATION PROCESS IS HANDCRAFTED. SMALL IMPERFECTIONS ARE INEVITABLE AND THEY ATTEST THE MANUAL EXECUTION OF THE PROCESS. THE PROCESS DOES NOT USE RAL CODES, THEREFORE THIS CAN GIVE RISE TO DIFFERENT SHADES OF COLOUR THAT CAN CHANGE FROM A PHASE OF PRODUCTION TO ANOTHER IN A DISTANCE OF TIME. THE COMPANY RESERVES AND GUARANTEES A CAREFUL QUALITY CONTROL.

SEHR GEEHRTE KUNDE WIR GRATULIEREN FÜR DEN KAUF UNSERER LEUCHTEN DIE METALLISIERUNG PROZESS ERFOLGT IN HANDWERKLICHE VERFAHREN KLEINE IMPERFEKTIONEN SIND NICHT VERHINDERBAR UND WERTSCHÄTZEN DAS KUNST-HANDWERK. LEIDER SIND KEINE STANDARD FARBSKALA EINSETZBAR DAHER SIND LEICHTE TON UNTERSCHIEDE IN DEM FARBERGEBNIS BEI UNTERSCHIEDLICHEN LIEFERUNGEN MÖGLICH. DIE FIRMA GARANTIERT EINE AKKURATE QUALITÄT KONTROLLE.

OWN THE LIGHT

OWN THE LIGHT, SMART LIGHT AND SYSTEM

È IL SISTEMA PENSATO DA CANGINI E TUCCI PER RENDERE UNICA E PERSONALE LA PROPRIA ESPERIENZA LUMINOSA.

RENDENDO LA LUCE VIVA GRAZIE AD UN SISTEMA DI DIMMERAZIONE E TUNABLE WHITE GESTIBILE DA UNA APP UTILIZZABILE SU QUALSIASI DISPOSITIVO SMART.

GRAZIE AD ESSA SARÀ POSSIBILE GESTIRE LA LUCE NON SOLO NELL'INTENSITÀ LUMINOSA MA ANCHE NEL COLORE, COSÌ DA POTER CREARE SEMPRE L'ATMOSFERA GIUSTA. NON SI TRATTERÀ PIÙ SOLO D'ILLUMINARE UN AMBIENTE.

OWN THE LIGHT È ANCHE TECNOLOGIA MECCANICA. GRAZIE AD UN SISTEMA "UP&DOWN" SIA NELLA STANZA CHE SOPRA AD UN TAVOLO SARÀ POSSIBILE REGOLARE LA DISTANZA CON UN SEMPLICE MOVIMENTO ALZANDO ED ABBASSANDO LA LAMPADA. AL RESTO PENSERÀ IL SOFISTICATO SISTEMA DI RIAVVOLGIMENTO INTERNO. CHE PERMETTERÀ ALLA LAMPADA DI RIMANERE SEMPRE STABILE.

CASAMBI

OWN THE LIGHT, SMART LIGHT AND SYSTEM DESIGNED BY CANGINI AND TUCCI FOR A UNIQUE AND PERSONAL LIGHT EXPERIENCE. MAKING THE LIGHT COME TO LIFE THANKS TO A DIMMING AND TUNABLE WHITE SYSTEM CONTROLLABLE BY AN APP THAT CAN BE USED ON ANY SMART DEVICE. THANKS TO THIS APP, IT WILL BE POSSIBLE TO MANAGE NOT ONLY THE LUMINOUS INTENSITY OF THE LIGHT BUT ALSO THE COLOUR, SO THAT ONE IS ALWAYS ABLE TO CREATE THE DESIRED ATMOSPHERE. IT WILL NO LONGER BE JUST ABOUT ILLUMINATING AN ENVIRONMENT.

OWN THE LIGHT IS MECHANICAL TECHNOLOGY AS WELL. THANKS TO AN "UP & DOWN" SYSTEM BOTH IN A ROOM OR ON A TABLE IT WILL BE POSSIBLE TO ADJUST THE DISTANCE WITH A SIMPLE MOVEMENT BY RAISING AND LOWERING THE LAMP. THE SOPHISTICATED INTERNAL REWINDING SYSTEM WILL TAKE CARE OF THE REST. THIS WILL ALLOW THE LAMP TO ALWAYS REMAIN STABLE.

OWN THE LIGHT, SMART LIGHT AND SYSTEM IST DAS SYSTEM, DAS VON CANGINI UND TUCCI ENTWICKELT WURDE, UM IHR BELEUCHTUNGSERLEBNIS EINZIGARTIG UND PERSÖNLICH ZU GESTALTEN. MIT UNSEREM SYSTEM WIRD DAS LICHT GEDIMMT UND DIE LICHT FARBE ÜBER EINE APP GESTEUERT, DIE AUF JEDEM BELIEBIGEN GERÄT VERWENDET WERDEN KANN. DADURCH WIRD ES MÖGLICH SEIN, DAS LICHT NICHT NUR IN DER LICHTINTENSITÄT, SONDERN AUCH IN DER LICHTFARBE ZU SYNCHRONISIEREN, SO DASS SIE IMMER DIE RICHTIGE ATMOSPHÄRE SCHAFFEN KÖNNEN. ES GEHT NICHT MEHR NUR DARUM, EINEN RAUM ZU BELEUCHTEN.

OWN THE LIGHT IST AUCH MECHANISCHE TECHNOLOGIE. DANK EINES "UP&DOWN"-SYSTEMS SOWOHL IM RAUM ALS AUCH ÜBER EINEM TISCH WIRD ES MÖGLICH SEIN, DEN ABSTAND MIT EINER EINFACHEN BEWEGUNG DURCH HEBEN UND SENKEN DER LAMPE EINZUSTELLEN. UM DEN REST KÜMMERT SICH DAS AUSGEKLÜGELTE INTERNE RÜCKSPULSYSTEM. DADURCH KANN DIE LAMPE JEDERZEIT STABIL BLEIBEN.



10%

100%

2700 K

5700 K

DIAMO VITA ALLA TUA IMMAGINA- ZIONE

**LET'S GIVE LIFE TO YOUR IMAGINATION
WIR ERWECKEN IHRE FANTASIE ZUM LEBEN**

SENTIAMO LA NECESSITÀ
DI ELABORARE E DARE VITA
ALLA VOSTRA IMMAGINAZIONE.

UN VALORE CHE CI CONTRADDISTINGUE
È LA REALIZZAZIONE
E PERSONALIZZAZIONE DEGLI AMBIENTI
IN BASE ALLE VOSTRE ESIGENZE.

LE NOSTRE "CASE HISTORY" UNITE
ALLA NOSTRA NATURA ARTIGIANA
CI PERMETTONO DI SUPPORTARE
LA VOSTRA IDEA ATTRAVERSO
LA NOSTRA VISIONE.

**IL NOSTRO UNICO LIMITE
È LA TUA IMMAGINAZIONE.**



WE'D LOVE TO BE ALLOWED TO WORK
ON AND GIVE LIFE TO YOUR IMAGINATION.

ONE OF OUR DISTINGUISHABLE TRAITS IS OUR ABILITY
TO CREATE AND CUSTOMISE ANY ENVIRONMENT
BASED ON YOUR NEEDS.

OUR ACQUIRED EXPERIENCE COMBINED
WITH OUR ARTISAN ABILITY ALLOW US TO SUPPORT YOUR
IDEAS TOGETHER WITH OUR PROFESSIONAL VISION.

OFTEN OUR ONLY LIMIT IS YOUR IMAGINATION.

WIR FÜHLEN DIE NOTWENDIGKEIT IHRE
PHANTASIE AUSZUARBEITEN.

UND ZUM LEBEN ZU ERWECKEN EIN WERT, DER UNS
AUSZEICHNET, IST DIE SCHAFFUNG UND ANPASSUNG
VON UMGEBUNGEN NACH IHREN BEDÜRFNISSEN.

UNSERE „CASE HISTORY“ IN VERBINDUNG MIT UNSERER
HANDWERKLICHEN NATUR ERMÖGLICHEN ES UNS, IHRE
IDEE DURCH UNSERE VISION ZU UNTERSTÜTZEN.

UNSERE EINZIGE GRENZE IST IHRE VORSTELLUNGSKRAFT.



CONTEMPORARY
COLLECTION



300G.
184



AUF
098



ARABESQUE
168



DOLIUM
108



ECLISSE
128



FIJI®
080



FLUTE
048



FOLD
020



GOCCIA
146



INTI
070



LACRIMA
174



LACRIMA MINI
180

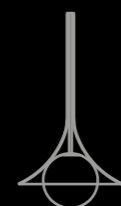

LADY LOUIS®
058



LANTERNA
162



LUC
154



PARIGI
138

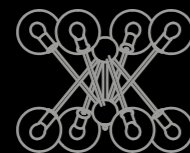

SCARLETT
092



TAO
118



ZOE®
034

CLASSIC
COLLECTION



ANASTASIA
192



COLOR
228



GLOBO
210

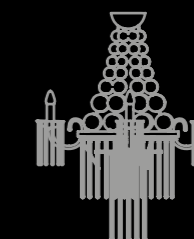

IMPERIAL
200



LAMPADE/PIANTANE
232



LOLITA
206



MAXIMILIAN
214



SOFFIO
224



TWIST
220

REFERENCES



240





CONTEMPORARY COLLECTION

Lampada Fold, Design by Cristian Li Voi

Cristian Li Voi Design Studio - Milano



LAUREATO NEL 2015 IN DESIGN SI TRASFERISCE A MILANO DOVE INIZIA A LAVORARE CON DENIS GUIDONE COLLABORANDO CON ROCHEBOBOIS, ICHENDORF, SERAX E PROJECTWATCHES. QUA MATURA LA SUA SENSIBILITÀ VERSO L'ESTETICA E LA FORMA. DAL 2016 COLLABORA CON NYXO STUDIO E A.T. RICEVE LA MENZIONE PER IL PROGETTO THE MAN'S HIGH NEST E COLLABORA CON ROSS LOVEGROVE PER IL PROGETTO TRANSMISSION ESPOSTO AL V&A LONDRA.

NEL 2018 ESPONE IL PROGETTO THE LOOPER PER IL DESIGN MUSEUM PORTLAND E COLLABORA AL PROGETTO TFS X.O-TEMPORARY FLEXIBLE STADIUM ROMA. NEL 2019 VINCE IL CONCORSO MORE THAN BACKPACK PER NAVA DESIGN E PUBBLICA IL LIBRO OVERWRITE CON LE PENSEUR PUBLISHER. DAL 2017 HA IL RUOLO DI DOCENTE ALLA LABA RIMINI E DAL 2018 ALLO IAAD BOLOGNA.

GRADUATING IN DESIGN IN 2015, HE MOVED TO MILAN TO START WORK ALONGSIDE DENIS GUIDONE IN COLLABORATIONS WITH ROCHE BOBOIS, ICHENDORF, SERAX AND PROJECT WATCHES.

IT WAS HERE THAT HE DEVELOPED A MATURE SENSITIVITY TO AESTHETICS AND FORM. SINCE 2016, HE HAS COLLABORATED WITH NYXO STUDIO AND A.T. HE RECEIVED A SPECIAL MENTION IN THE PROJECT ENTITLED 'THE MAN'S HIGH NEST' AND COLLABORATED WITH ROSS LOVEGROVE ON THE 'TRANSMISSION' PROJECT EXHIBITED AT THE V&A IN LONDON.

IN 2018, HE EXHIBITED 'THE LOOPER' AT THE PORTLAND DESIGN MUSEUM AND COLLABORATED ON THE 'TEMPORARY FLEXIBLE STADIUM X.O.' PROJECT IN ROME.

IN 2019, HE WON NAVA DESIGN'S 'MORE THAN BACKPACK' COMPETITION AND PUBLISHED THE BOOK 'OVERWRITE' WITH THE PUBLISHER LE PENSEUR. HE HAS BEEN TEACHING AT THE FINE ARTS ACADEMY LABA RIMINI SINCE 2017, AND AT THE INSTITUTE OF APPLIED ART AND DESIGN (IAAD) BOLOGNA SINCE 2018.



IL TERMINE FOLD SIGNIFICA PIEGARE, ED IN QUESTO CASO PUÒ ESSERE TRADOTTO NELLA SUA FORMA PIÙ SEMPLICE, CIOÈ L'AZIONE CHE SI APPLICA AD UN OGGETTO IN MODO TALE CHE ASSUMA UNA FORMA DIVERSA DA QUELLA INIZIALE, DIVENTANDO QUALCOSA DI NUOVO. I CONTRASTI TRA PRIMA E DOPO, SEMPLICE E COMPLESSO, LONTANO E VICINO, SONO TUTTI PARTE DELLA RICERCA CHE HA PORTATO ALLA NASCITA DI FOLD. LA FORMA DELLA LAMPADA, ESTERNAMENTE, RIVELA UNA SILHOUETTE DOVE LA PARTE SUPERIORE ED INFERIORE SONO LONTANE.

THE TERM "FOLD" IN ITS SIMPLEST INTERPRETATION IS AN ACTION APPLIED TO AN OBJECT IN SUCH A WAY THAT IT TAKES ON A NEW SHAPE, BECOMING SOMETHING RATHER DIFFERENT. A FOLD'S CONTRAST BETWEEN BEFORE AND AFTER, SIMPLE AND COMPLEX, AND FAR AND NEAR, ARE ALL PART OF THE RESEARCH THAT LED TO THE CREATION OF THE LAMP CALLED FOLD. FOLD'S OUTLINE TRACES A SILHOUETTE THAT SETS ITS UPPER AND LOWER PARTS FAR APART, ALLOWING LIGHT TO PLAY IN THE

IN QUEST'AREA, LA LUCE GIOCA NELLO SPAZIO E CI PERMETTE DI ANDARE OLTRE CON LO SGUARDO FINO AL CENTRO. QUA IL PROFILO SUBISCE UNA VARIAZIONE, SOPRA E SOTTO PERDONO DI SIGNIFICATO CREANDO UN TUTT'UNO CON IL BAGLIORE, UN'ILLUSIONE, CHE, PER UN MOMENTO, NON CI PERMETTE DI COMPRENDERE DA DOVE VENGA LA LUCE. LA FLESSIONE CENTRALE DI FOLD PERMETTE DI INTEGRARE NEL VETRO IL CORPO ILLUMINANTE, AGGIUNGENDO UNA FUNZIONE TECNICA AL VALORE ESTETICO. QUESTO È TUTTO CIÒ CHE DERIVA DA UN GESTO SEMPLICE E COMPLESSO ALLO STESSO TEMPO, UNA PIEGA, FOLD.

GAP IN-BETWEEN, DRAWING OUR GAZE TOWARDS ITS CENTRE. HERE, THE FORM UNDERGOES A STRIKING CHANGE. ABOVE AND BELOW LOSE MEANING, CREATING A ONENESS, AN ILLUSION THAT OBFUSCATES WHERE EXACTLY THE LIGHT COMES FROM. ITS SOURCE IS, IN FACT, FULLY INCORPORATED WITHIN THE GLASS OF FOLD'S CENTRAL CREASE, ADDING TECHNICAL ACCOMPLISHMENT TO THE LAMP'S HIGH AESTHETIC VALUE. ALL THIS COMES FROM A GESTURE AT ONCE SIMPLE AND COMPLEX, A FOLD.



**LAMPADA A SOSPENSIONE,
PLAFONIERA E BINARIO**

*HANGING LAMP, CEILING LAMP
AND CEILING TRACK*



GIG1516.1L



GIG1513.1L



1513.1L

GIG1513.1L





1516.1L



GIG1517.120.3L

FOLD

STRUTTURA METALLICA DISPONIBILE / AVAILABLE METAL STRUCTURE:
NERO, CROMO / BLACK, CROME

AVAILABLE WITH UP & DOWN SYSTEM
DISPONIBILE ANCHE CON SISTEMA UP&DOWN

CASAMBI

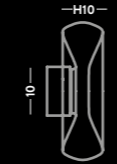

1516.1L

Plafoniera-applique
Ceiling lamp-wall lamp
vetro/glass Ø24 cm - H10 cm

1 x LED 12,8W Dimmer Triac - 1615 Lm - 126 Lm/W
CC 350mA - CRI Typ.95 - 32 - 40V
180° - 3 step MacAdam - 2700°K / 3000°K

CE IP20 Δ 1m

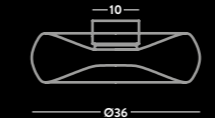

GIG1516.1L

Plafoniera-applique
Ceiling lamp-wall lamp
vetro/glass Ø36 cm - H13 cm

1 x LED 12,8W Dimmer Triac - 1615 Lm - 126 Lm/W
CC 350mA - CRI Typ.95 - 32 - 40V
180° - 3 step MacAdam - 2700°K / 3000°K

CE IP20 Δ 1m

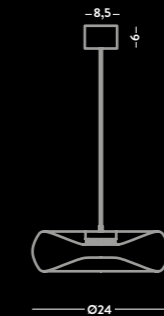

1513.1L

Sospensione / Hanging lamp
vetro/glass Ø24 cm - cavo/cable 150 cm

1 x LED 17,4W Dimmer Triac - 2370 Lm - 134,3 Lm/W
CC 500mA - CRI Typ.95 - 32 - 40V
180° - 3 step MacAdam - 2700°K / 3000°K

CE IP20 Δ 1m

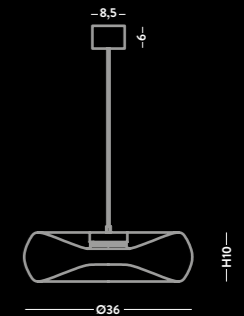

GIG1513.1L

Sospensione / Hanging lamp
vetro/glass Ø36 cm - cavo/cable 150 cm

1 x LED 17,4W Dimmer Triac - 2370 Lm - 134,3 Lm/W
CC 500mA - CRI Typ.95 - 32 - 40V
180° - 3 step MacAdam - 2700°K / 3000°K

CE IP20 Δ 1m

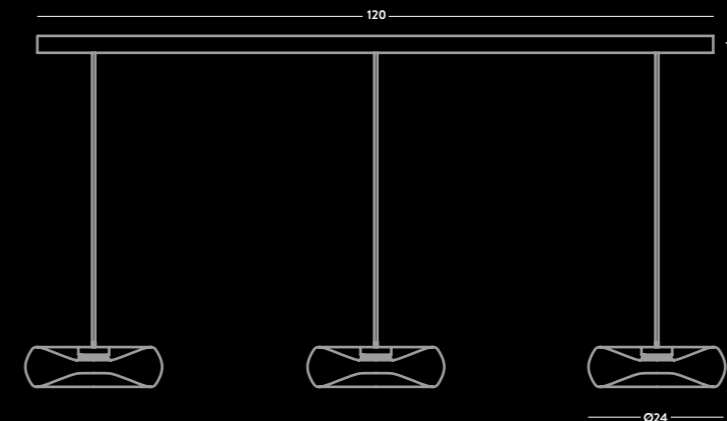

1517.120.3L

Binario a sotto / Ceiling track
L124 - P24 cm - cavo/cable 150 cm

3 x LED 17,4W Dimmer Triac - 2370 Lm - 134,3 Lm/W
CC 500mA - CRI Typ.95 - 32 - 40V
180° - 3 step MacAdam - 2700°K / 3000°K

CE IP20 Δ 1m

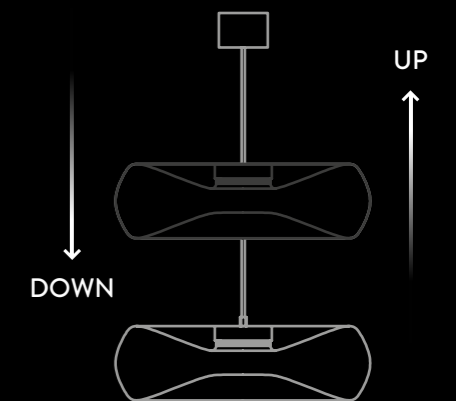

DISPONIBILE SISTEMA
UP E DOWN VEDI FIJI PAG. 83.
PARTE INFERIORE SATINATA

AVAILABLE UP AND DOWN
SYSTEM AS FIJI PAG. 83.
LOWER PART SATIN

- COMPATIBILE CON CASAMBI / COMPATIBLE WITH CASAMBI
- A RICHIESTA: COMPONENTI UL +10% / ON DEMAND: UL COMPONENTS +10%
- CAVO ELETTRICO IN GOMMA NERO / BLACK RUBBER ELECTRIC CABLE
- DRIVER INCLUSO / DRIVER INCLUDED
- DIMMERABILE: SÌ - SCHEDA LED SOSTITUIBILE DA PROFESSIONISTA
DIMMABLE: YES - LED IS REPLACEABLE BY PROFESSIONAL

1517.120.3L
BINARIO / CEILING TRACK:
ACCIAIO INOX RILUCIDATO
STAINLESS POLISHED STEEL

I LUMEN INDICATI CORRISPONDONO
ALL'INTENSITÀ LUMINOSA
ALL'ORIGINE DELLA SCHEDA LED
LUMEN INDICATED CORRESPONDS TO
THE LUMINOUS INTENSITY AT THE ORIGIN
OF THE LED BOARD

COLORI VETRO DISPONIBILI / AVAILABLE GLASS COLOURS



01 - Trasparente
Transparent

03 - Rosa
Pink

05 - Ambra
Amber

06 - Verde
Green

07 - Azzurro
Sky-blue

08 - Fumè
Fume

16 - Tabacco
Tobacco

17 - Rubino
Ruby

ARTICOLI GIG NEL COLORE FUMÈ: SUPPLEMENTO DEL 10% SUL PREZZO DEL COLORATO / PRODUCTS GIG IN FUME COLOR: 10% SURCHARGE ON THE PRICE OF THE COLOURED



ZOE®

**LAMPADA DA TAVOLO, APPLIQUE,
SOSPENSIONE, BINARIO E PLAFONIERA**

*TABLE LAMP, WALL LAMP, HANGING LAMP,
CEILING TRACK AND CEILING LAMP*





XXL1303.1L



PARALUMI CINETTE DISPONIBILI PER LA LINEA ZOE
 CINETTE LAMP SHADES AVAILABLE FOR ZOE

CI - BIANCO / ARGENTO
 CI - WHITE / SILVER



CI - BIANCO / ORO
 CI - WHITE / GOLD



CI - NERO / ARGENTO
 CI - BLACK / SILVER



CI - NERO / ORO
 CI - BLACK / GOLD





GIG1307.120.3L



XXL1303.1L

AP1301.1L



1309MX.3L



ZOE®

STRUTTURA METALLICA DISPONIBILE / AVAILABLE METAL STRUCTURE:
CROMO / CHROME

(A RICHIESTA: ROSONE BIANCO, NERO, ACCIAIO SPAZZOLATO, FOGLIA ORO-ARGENTO)
(ON DEMAND: WHITE, BLACK, BRUSHED STEEL, GOLD-SILVER LEAF CANOPY)

ULTERIORI COMPOSIZIONI A RICHIESTA
ADDITIONAL COMPOSITIONS ON DEMAND



LU1300

Lampada da tavolo / Table lamp

vetro/glass Ø16 cm - H33 cm

1 G9 x max 33W 230V

CE IP20 1m



LUGIG1300

Lampada da tavolo / Table lamp

vetro/glass Ø22 cm - H43 cm

1 E27 x max 60W 220-240V

CE IP20 1m



LUXXL1300

Lampada da tavolo / Table lamp

vetro/glass Ø30 cm - H58 cm

1 E27 x max 60W 220-240V

CE IP20 1m



LU1303

Lampada da tavolo / Table lamp

vetro/glass Ø16 cm - H43 cm

1 E14 x max 40W 220-240V

1 LED x 4,3W 350 LUMEN 3.000K

CE IP20 1m



LUGIG1303

Lampada da tavolo / Table lamp

vetro/glass Ø22 cm - H58 cm

1 E27 x max 60W 220-240V

1 LED x 4,3W 350 LUMEN 3.000K

CE IP20 1m



LUXXL1303

Lampada da tavolo / Table lamp

vetro/glass Ø30 cm - H78 cm

1 E27 x max 60W 220-240V

1 LED x 4,3W 350 LUMEN 3.000K

CE IP20 1m

LU1303 - LUGIG1303 - LUXXL1303

I LUMEN INDICATI CORRISPONDONO ALL'INTENSITÀ LUMINOSA ALL'ORIGINE DELLA SCHEDA LED
LUMEN INDICATED CORRESPONDS TO THE LUMINOUS INTENSITY AT THE ORIGIN OF THE LED BOARD

COLORI VETRO DISPONIBILI / AVAILABLE GLASS COLOURS

01 - Trasparente
Transparent03 - Rosa
Pink05 - Ambra
Amber06 - Verde
Green07 - Azzurro
Sky-blue08 - Fumè
Fume16 - Tabacco
Tobacco17 - Rubino
Ruby

ARTICOLI GIG E XXL NEL COLORE FUMÈ: SUPPLEMENTO DEL 10% SUL PREZZO DEL COLORATO / PRODUCTS GIG AND XXL IN FUME COLOR: 10% SURCHARGE ON THE PRICE OF THE COLOURED

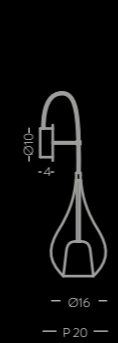

AP1301.1L

Applique / Wall lamp

vetro/glass Ø16 cm - cavo/cable 50 cm

1 *G9 x max 48W 230V

CE IP20 1m



1303.1L

Sospensione / Hanging lamp

vetro/glass Ø16 cm - cavo/cable 150 cm

1 *G9 x max 48W 230V

CE IP20 1m



GIG1303.1L

Sospensione / Hanging lamp

vetro/glass Ø22 cm - cavo/cable 150 cm

1 E27 x max 105W 220-240V

CE IP20 1m

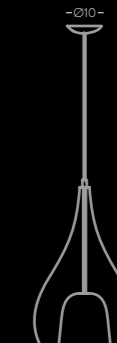

XXL1303.1L

Sospensione / Hanging lamp

vetro/glass Ø30 cm - cavo/cable 150 cm

1 E27 x max 105W 220-240V

CE IP20 1m

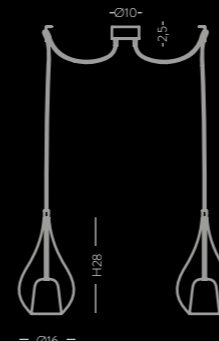

1303.2L

Sospensione / Hanging lamp

vetro/glass Ø16 cm - cavo/cable 250 cm

2 *G9 x max 48W 230V

CE IP20 1m

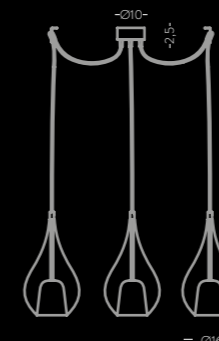

1303.3L

Sospensione / Hanging lamp

vetro/glass Ø16 cm - cavo/cable 250 cm

3 *G9 x max 48W 230V

CE IP20 1m

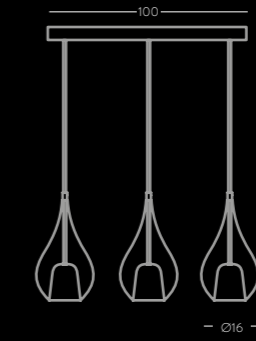

1307.3L

Binario a soffitto / Ceiling track

vetro/glass Ø16 cm - cavo/cable 150 cm

3 *G9 x max 48W 230V

CE IP20 1m

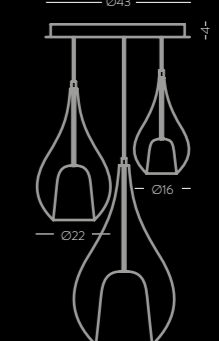

1309MX.3L

Plafoniera / Ceiling lamp

vetro/glass Ø16/22/30 cm - cavo/cable 150 cm

1 *G9 x max 48W 2 E27 x max 105W 220-240V

CE IP20 1m

A RICHIESTA / ON DEMAND

* SOSPENSIONE / APPLIQUE G9 PUÒ ESSERE REALIZZATA CON ATTACCO E14
* HANGING / WALL LAMP G9 CAN BE MADE WITH E14

1307.3L

BINARIO / CEILING TRACK:
ACCIAIO INOX RILUCIDATO
STAINLESS POLISHED STEEL

1309MX.3L

PLAFONIERA / CEILING LAMP:
ACCIAIO INOX RILUCIDATO / STAINLESS POLISHED STEEL

COLORI VETRO METALLIZZATO DISPONIBILI / METALLIC GLASS COLOURS AVAILABLE

Nero
BlackAcciaio
SteelOro
GoldOro rosa
Rose goldBronzo
BronzeArcobaleno
Rainbow

MODELLO ZOE DISPONIBILE ANCHE
NELLA VERSIONE VAN GOGH,
(VEDI CATALOGO DI RIFERIMENTO).
MODEL ZOE ALSO AVAILABLE
IN THE VAN GOGH VERSION,
(SEE REFERENCE CATALOGUE).



FLUTE

**LAMPADA DA TAVOLO, APPLIQUE,
SOSPENSIONE, BINARIO E PLAFONIERA**

*TABLE LAMP, WALL LAMP, HANGING LAMP,
CEILING TRACK AND CEILING LAMP*



XXL1393.1L



1399MX.43.3L



LUGI1390.1L



GIG1397.120.3L



AP1391.1L

1393MX.2L

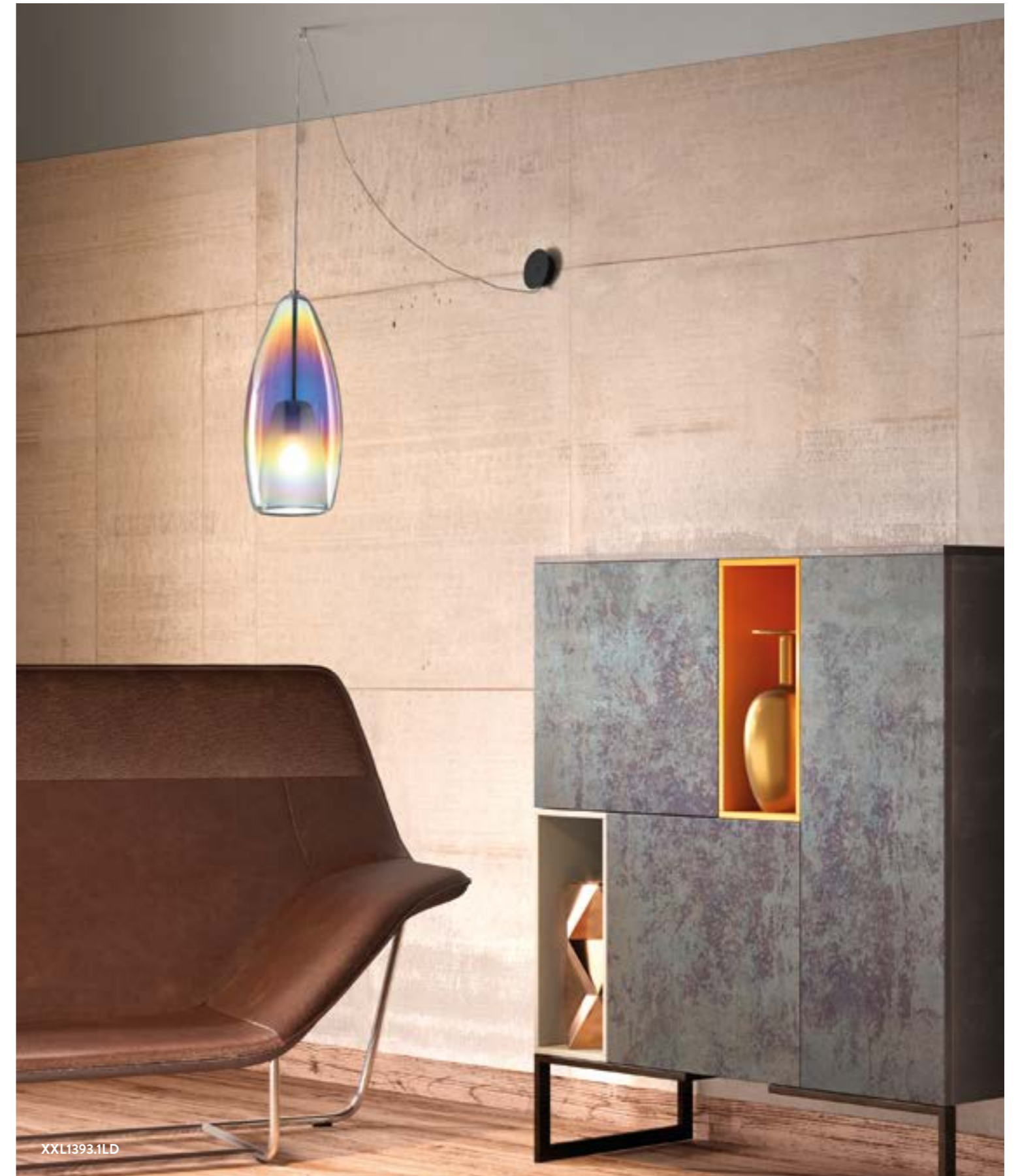

XXL1393.1LD

FLUTE

STRUTTURA METALLICA DISPONIBILE / AVAILABLE METAL STRUCTURE:
CROMO/CHROME - NERO/BLACK - BIANCO/WHITE

ULTERIORI COMPOSIZIONI A RICHIESTA
ADDITIONAL COMPOSITIONS ON DEMAND



1393.1L

Sospensione / Hanging lamp
vetro/glass Ø12 cm - cavo/cable 150 cm
1 E14 x max 60W 220-240V
CE IP20 1m



GIG1393.1L

Sospensione / Hanging lamp
vetro/glass Ø16 cm - cavo/cable 150 cm
1 E27 x max 105W 220-240V
CE IP20 1m



XXL1393.1L

Sospensione / Hanging lamp
vetro/glass Ø20 cm - cavo/cable 150 cm
1 E27 x max 105W 220-240V
CE IP20 1m

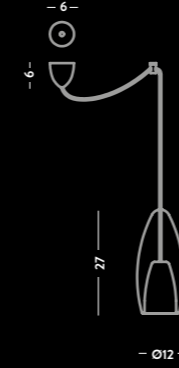

1393.1LD

Sospensione / Hanging lamp
vetro/glass Ø12 cm - cavo/cable 250 cm
1 E14 x max 60W 220-240V
CE IP20 1m

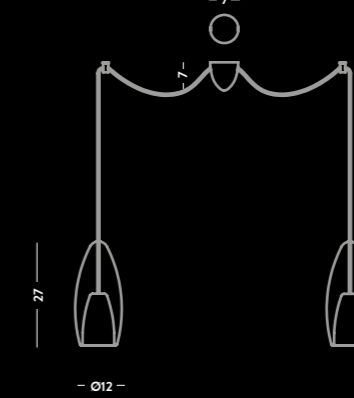

1393.2L

Sospensione / Hanging lamp
vetro/glass Ø12 cm - cavo/cable 250 cm
2 E14 x max 60W 220-240V
CE IP20 1m

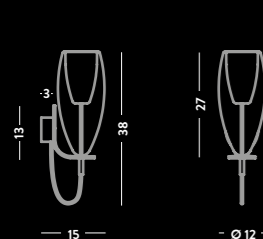

AP1391.1L

Applique / Wall lamp
vetro/glass Ø12 cm - cavo/cable 50 cm
1 E14 x max 60W 220-240V
CE IP20 1m



LU1390.1L

Lampada da tavolo / Table lamp
vetro/glass Ø12 cm - H 31 cm
1 E14 x max 60W 220-240V
CE IP20 1m

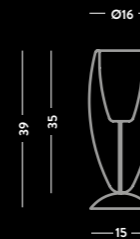

LUGIG1390.1L

Lampada da tavolo / Table lamp
vetro/glass Ø16 cm - H 39 cm
1 E27 x max 105W 220-240V
CE IP20 1m

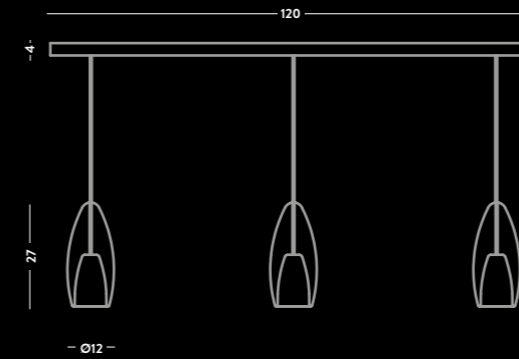

1397.120.3L

Binario a soffitto / Ceiling track
vetro/glass Ø12 cm - cavo/cable 150 cm
3 E14 x max 60W 220-240V
CE IP20 1m

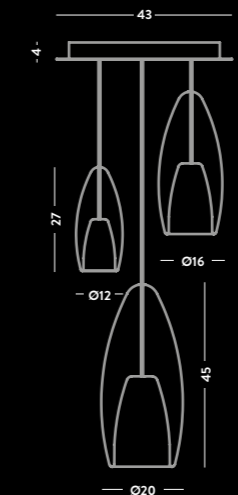

1399MX.43.3L

Plafoniera / Ceiling lamp
vetro/glass Ø12/16/20 cm - cavo/cable 150 cm
2 E27 x max 105W 1 E14 x max 60W 220-240V
CE IP20 1m

1397.120.3L
BINARIO / CEILING TRACK:
ACCIAIO INOX RILUCIDATO / STAINLESS POLISHED STEEL

1399MX.43.3L
PLAFONIERA / CEILING LAMP:
ACCIAIO INOX RILUCIDATO / STAINLESS POLISHED STEEL

COLORI VETRO DISPONIBILI / AVAILABLE GLASS COLOURS



ARTICOLI GIG E XXL NEL COLORE FUMÈ: SUPPLEMENTO DEL 10% SUL PREZZO DEL COLORATO / PRODUCTS GIG AND XXL IN FUME COLOR: 10% SURCHARGE ON THE PRICE OF THE COLOURED

COLORI VETRO METALLIZZATO DISPONIBILI / METALLIC GLASS COLOURS AVAILABLE

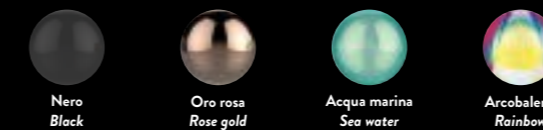

STRUTTURA METALLICA DISPONIBILE / AVAILABLE METAL STRUCTURE

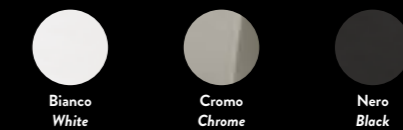

Lampada Lady Louis, disegnata da Alberto Manzoni

Labomaki Studio - Cesena



NATO A CESENA NEL 1983, HA STUDIATO PRIMA A FIRENZE E POI AL POLITECNICO DI MILANO DOVE È STATO ANCHE DOCENTE AL CORSO DI PRODUCT SERVICE SYSTEM DESIGN E AL MASTER IN STRATEGIC DESIGN DI POLI.DESIGN. NELLA SUA CARRIERA HA COLLABORATO CON AZIENDE MULTINAZIONALI COME PANASONIC, B&B ITALIA, TECHNOGYM E CHICCO ED HA AVUTO L'OPPORTUNITÀ DI LAVORARE IN AMBITO INTERNAZIONALE COLLABORANDO CON LA HANGZHOU DIANZI UNIVERSITY IN CINA E CON SENAI IN BRASILE. NEL 2011 VINCE IL "LISSONE DESIGN AWARD FOR PUBLIC FURNITURE DESIGN", CON UN PROGETTO DI ARREDO URBANO SMART, NEL 2013 IL PREMIO EUROPEO "CCALPS

BORN IN CESENA IN 1983, HE STUDIED FIRST IN FLORENCE AND THEN AT THE POLITECNICO DI MILANO WHERE HE ALSO TAUGHT AT THE PRODUCT SERVICE SYSTEM DESIGN COURSE AND THE POLI.DESIGN MASTER IN STRATEGIC DESIGN. DURING HIS CAREER HE HAS COLLABORATED WITH MULTINATIONAL COMPANIES SUCH AS PANASONIC, B&B ITALIA, TECHNOGYM AND CHICCO AND HAS HAD THE OPPORTUNITY TO WORK INTERNATIONALLY COLLABORATING WITH HANGZHOU DIANZI UNIVERSITY IN CHINA AND SENAI IN BRAZIL. IN 2011 HE WON THE "LISSONE DESIGN AWARD FOR PUBLIC FURNITURE DESIGN" WITH A SMART URBAN FURNITURE PROJECT, IN 2013

CREATIVE CAMP FOR NEW START UP" CON UN PROGETTO SULLA RIQUALIFICAZIONE DEI MERCATI COPERTI DI MILANO, NEL 2016 VIENE PUBBLICATO SU ADI DESIGN INDEX "OVO" UN AMPLIFICATORE PASSIVO IN MARMO, REALIZZATO DA MONITILLO MARMI. NEL 2014 FONDA LABOMAKI SRL, STUDIO DI PROGETTAZIONE CHE SI OCCUPA DI BRAND DESIGN, DESIGN DEL PRODOTTO E DEGLI INTERNI E SEGUE CANGINI E TUCCI IN PROGETTI DI SVILUPPO STRATEGICO, DI COMUNICAZIONE E DI ART DIRECTION. NEL 2019 COMINCIA LA COLLABORAZIONE CON IL VAN GOGH MUSEUM DI AMSTERDAM E GESTISCE LE ATTIVITÀ DI CO-BRANDING INSIEME ALL'AZIENDA.

THE EUROPEAN AWARD "CCALPS CREATIVE CAMP FOR NEW START UP" WITH A PROJECT ON THE REDEVELOPMENT OF COVERED MARKETS IN MILAN, IN 2016 "OVO" A PASSIVE MARBLE AMPLIFIER MADE BY MONITILLO MARMI WAS PUBLISHED ON ADI DESIGN INDEX. IN 2014 HE FOUNDED LABOMAKI SRL, A DESIGN STUDIO THAT DEALS WITH BRAND DESIGN, PRODUCT AND INTERIOR DESIGN AND FOLLOWS CANGINI AND TUCCI IN STRATEGIC DEVELOPMENT, COMMUNICATION AND ART DIRECTION PROJECTS. IN 2019 HE STARTS THE COLLABORATION WITH THE VAN GOGH MUSEUM IN AMSTERDAM AND MANAGES THE CO-BRANDING ACTIVITIES TOGETHER WITH THE COMPANY.



LADY
LOUISIS®

VALAIDA SNOW È STATA UNA GRANDE TROMBETTISTA E CANTANTE DEGLI ANNI TRENTA, PROBABILMENTE LA PIONIERA DELLE ESECUTRICI CON LA TROMBA, OLTRE AD ESSER UNA ECCELLENTE CANTANTE ED UN'APPREZZATA ARRANGIATRICE. NATA IL 2 GIUGNO 1905 NELLA CITTÀ DI CHATTANOOGA NEL TENNESSEE ERA CONOSCIUTA COME "LA REGINA DELLA TROMBA E DELLA CANZONE", "LA DONNA LOUIS ARMSTRONG", "LITTLE LOUIS" E "LADY LOUIS". ERA UN'ARTISTA ECCEZIONALE SAPEVA SUONARE CON GRANDE ABILITÀ, CANTAVA MAGNIFICAMENTE, ERA ELEGANTE, SAPEVA BALLARE BENISSIMO E SUL PALCO AVEVA GRANDE FEELING ED UN ECCEZIONALE CARISMA.

VALAIDA SNOW WAS A GREAT TRUMPET PLAYER AND SINGER OF THE THIRTIES, PROBABLY THE PIONEER OF TRUMPET PERFORMERS, BESIDES BEING AN EXCELLENT SINGER AND RENOWNED ARRANGER. BORN ON JUNE 2, 1905 IN THE CITY OF CHATTANOOGA, TENNESSEE, SHE WAS KNOWN AS "QUEEN OF THE TRUMPET AND SONGS", "THE FEMALE LOUIS ARMSTRONG", "LITTLE LOUIS" AND "LADY LOUIS". TALENTED AND EXCEPTIONAL PLAYER, EXCITING VOCALIST, ATTRACTIVE, EXCELLENT DANCER AND AN IRRESISTIBLE PERFORMER, POPULAR FOR HER HYPNOTIC SCATTING

QUESTA LAMPADA È UN OMAGGIO AL LAVORO E ALLA CARRIERA DI VALAIDA E DI TUTTE LE DONNE CHE HANNO DECISO DI INTRAPRENDERE UN MESTIERE "DA UOMO" FACENDO RISPLENDERE LA LUCE DELL'ARTE, DELLA FANTASIA E DELLA CREATIVITÀ. LA LAMPADA È COSTITUITA DA UN CORPO IN VETRO CHE RIPRENDE LA SILHOUETTE DI UNA TROMBA E DA UNA SFERA, ANCH'ESSA IN VETRO MA OPALINO, CHE DIFFONDE LA LUCE COME FOSSE UNA SORDINA. LA LAMPADA A SOSPENSIONE VIENE REALIZZATA IN 3 VARIANTI DIMENSIONALI E DIVERSE FINITURE E COLORI TRA CUI L'ORO METALLIZZATO, IL TRASPARENTE E I COLORI IN FINITURA OPACA.

AND EXCEPTIONAL CHARISMA. THIS LAMP IS A TRIBUTE TO VALAIDA'S WORK AND CAREER OF ALL HARD-WORKING WOMEN WHO EMBRACED MEN'S WORK BY SHINING THE LIGHT OF ART, IMAGINATION AND CREATIVITY. TRUMPET SHAPED AND SPHERICAL SILHOUETTE OPAL GLASS LAMP, SOFTLY DIFFUSING LIGHT. 3-DIMENSIONAL SUSPENSION LAMP SYSTEM WITH DIFFERENT KINDS OF FINISHES AND COLORS INCLUDING METALLIC GOLD AND OPAQUE FINISH.



**LAMPADA A SOSPENSIONE,
PLAFONIERA E BINARIO**

*HANGING LAMP, CEILING LAMP
AND CEILING TRACK*



XXL1473.1L



GIG1473.1L 1473.1L



1473MX.3L



1473.1L

XXL1473.1L

GIG1473.1L



GIG1473.1L

1473.1L



GIG1477.120.3L



XXL1473.1L



1475MX.3L

LADY LOUIS®

STRUTTURA METALLICA DISPONIBILE / AVAILABLE METAL STRUCTURE:
CROMO/CHROME - NERO/BLACK

ULTERIORI COMPOSIZIONI A RICHIESTA
ADDITIONAL COMPOSITIONS ON DEMAND

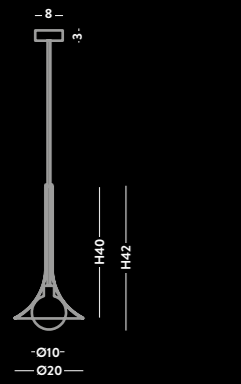

1473.1L

Sospensione / Hanging lamp

vetro/glass Ø20 H42 cm - cavo/cable 150 cm

1 G9 x max 42W 230V

CE IP20 (1m)

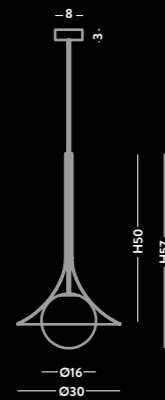

GIG1473.1L

Sospensione / Hanging lamp

vetro/glass Ø30 H57 cm - cavo/cable 150 cm

1 E27 x max 70W 220-240V

CE IP20 (1m)

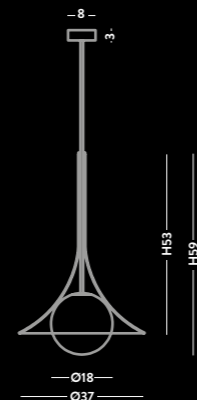

XXL1473.1L

Sospensione / Hanging lamp

vetro/glass Ø37 H59 cm - cavo/cable 150 cm

1 E27 x max 70W 220-240V

CE IP20 (1m)

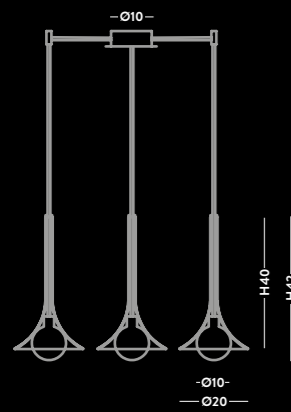

1473.3L

Sospensione / Hanging lamp

vetro/glass Ø20 H42 cm - cavo/cable 250 cm

3 G9 x max 42W 230V

CE IP20 (1m)

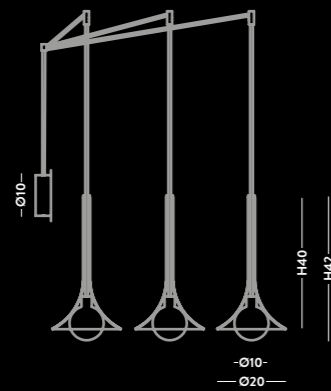

1475.3L

Sospensione / Hanging lamp

vetro/glass Ø20 H42 cm - cavo/cable 250 cm

3 G9 x max 42W 230V

CE IP20 (1m)

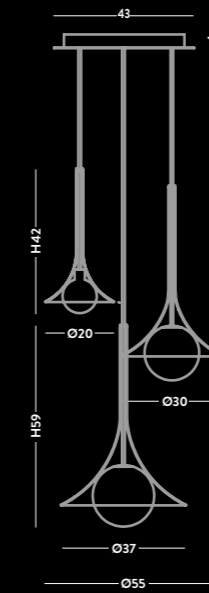

1479MX.43.3L

Plafoniera / Ceiling lamp

Ø55 cm - cavo/cable 150 cm

1 G9 x max 42W 2 E27 x max 70W 220-240V

CE IP20 (1m)

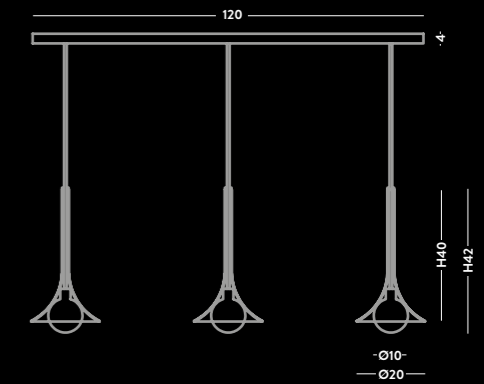

1477.120.3L

Binario a soffitto / Ceiling track

L120 - P20 cm - cavo/cable 150 cm

3 G9 x max 42W 230V

CE IP20 (1m)

1479MX.43.3L
PLAFONIERA / CEILING LAMP:
ACCIAIO INOX RILUCIDATO / STAINLESS POLISHED STEEL

1477.120.3L
BINARIO / CEILING TRACK:
ACCIAIO INOX RILUCIDATO / STAINLESS POLISHED STEEL

- CAVO ELETTRICO IN GOMMA NERO O TRASPARENTE / BLACK RUBBER OR TRANSPARENT ELECTRIC CABLE
- DIFFUSORE IN VETRO SABBIAIO / DIFFUSER IN SANDED GLASS

COLORI VETRO DISPONIBILI / AVAILABLE GLASS COLOURS



01 - Trasparente
Transparent

05 - Ambra
Amber

COLORI VETRO METALLIZZATO DISPONIBILI / METALLIC GLASS COLOURS AVAILABLE



Aubergine
Aubergine

Oro
Gold

Bronzo
Bronze

INTI ERA LA DIVINITÀ INCA DEL SOLE, UN GIORNO ORDINÒ AI SUOI FIGLI DI COSTRUIRE LA CAPITALE DEL REGNO. ESSI AVREBBERO DOVUTO VAGARE PER LA TERRA CON UN DIVINO BASTONE D'ORO E AVREBBERO DOVUTO CONFICCARLO NEL LUOGO PREDESTINATO ALLA CREAZIONE DELLA CITTÀ. COSÌ NACQUE CUZCO E SI SVILUPPÒ LA CIVILTÀ INCA. SONO PARTITO DA QUESTO MITO COME ISPIRAZIONE PER LA NUOVA FAMIGLIA DI PRODOTTO PER CANGINI E TUCCI. LA SCELTA DEI MATERIALI È STATA FONDAMENTALE PER LO SVILUPPO DELLA LINEA. HO SCELTO L'OTTONE COME ELEMENTO STRUTTURALE PER L'INTERA FAMIGLIA, SVILUPPANDOLO IN TRE VARIANTI DI FINITURA: LO SPAZZOLATO, IL BRUNITO ED IL RAMATO. IL VETRO È STATO TRATTATO CON UNA FINITURA A GRADIENTE CHE VA SFUMANDO DAL BIANCO OPACO AL TRASPARENTE, IN MODO DA EVITARE L'ABBAGLIAMENTO QUANDO SI GUARDA DIRETTAMENTE LA LAMPADA. QUESTO PROCESSO, COSÌ COME LO SVILUPPO DI TUTTI I VETRI CANGINI E TUCCI, È REALIZZATO INTERAMENTE A MANO E RENDE OGNI PRODOTTO DIVERSO DAGLI ALTRI. RACCONTA UNA STORIA FATTA DI ARTIGIANALITÀ, DI CURA DEL DETTAGLIO E DI RAPPORTO DIRETTO TRA MAESTRO SOFFIATORE E VETRO. EVENTUALI IMPERFEZIONI DI FINITURA SONO DA CONSIDERARE SEGNI FONDAMENTALI DI QUESTO RACCONTO PERCHÉ SECONDO NOI MADE IN ITALY SIGNIFICA SOPRATTUTTO UNICITÀ E FATTO A MANO. IL TERZO MATERIALE È IL CEMENTO, UTILIZZATO PER REALIZZARE I ROSONI, I BINARI E LE BASI DELLA PIANTANA, GLI ELEMENTI CHE VANNO A TOCCARE DIRETTAMENTE LA STRUTTURA DELL'ABITAZIONE. L'ARTIGIANALITÀ DEL PROCESSO DI REALIZZAZIONE DEGLI ELEMENTI IN CEMENTO FA SÌ CHE OGNI PEZZO SIA UNICO, DIFFERENTE DA TUTTI GLI ALTRI COME FINITURA SUPERFICIALE E IMPREZIOSITO DA DETTAGLI TIPICI DELLE MALTE CEMENTIZIE, QUALI VENATURE E MICROPOROSITÀ. INTI È UN MIX DI TRADIZIONE ARTIGIANA E INNOVAZIONE TECNOLOGICA, L'INTERA FAMIGLIA È STATA PROGETTATA E REALIZZATA IN ITALIA, FONDENDO LA CONOSCENZA ARTIGIANA CON METODOLOGIE DI LAVORAZIONE ALL'AVANGUARDIA, QUALI LA STAMPA 3D E LA PROTOTIPAZIONE RAPIDA.

INTI WAS THE INCA DIVINITY OF THE SUN, ONE DAY HE ORDERED HIS SONS TO BUILD THE CAPITAL OF THE KINGDOM. THEY WOULD HAVE TO WANDER THE EARTH WITH A DIVINE STICK OF GOLD AND WOULD HAVE TO STICK IT IN THE PLACE PREDESTINED FOR THE CREATION OF THE CITY. THUS CUZCO WAS BORN AND THE INCA CIVILIZATION DEVELOPED. I STARTED FROM THIS MYTH AS INSPIRATION FOR THE NEW PRODUCT FAMILY FOR CANGINI AND TUCCI. THE CHOICE OF MATERIALS WAS FUNDAMENTAL FOR THE DEVELOPMENT OF THE LINE. I CHOSE BRASS AS THE STRUCTURAL ELEMENT FOR THE WHOLE FAMILY, DEVELOPING IT IN THREE FINISHING VARIANTS: BRUSHED, BURNISHED AND COPPERED. THE GLASS HAS BEEN TREATED WITH A GRADIENT FINISH THAT GOES FROM OPAQUE WHITE TO TRANSPARENT TO AVOID DAZZLING WHEN YOU LOOK DIRECTLY AT THE LAMP.

THIS PROCESS, AS WELL AS THE DEVELOPMENT OF ALL CANGINI AND TUCCI GLASSES, IS MADE ENTIRELY BY HAND AND MAKES EACH PRODUCT DIFFERENT FROM THE OTHERS.

IT TELLS A STORY OF CRAFTSMANSHIP, ATTENTION TO DETAIL AND DIRECT RELATIONSHIP BETWEEN MASTER BLOWER AND GLASS. IMPERFECTIONS OF FINISH ARE TO BE CONSIDERED FUNDAMENTAL SIGNS OF THIS STORY BECAUSE ACCORDING TO US MADE IN ITALY MEANS ABOVE ALL UNIQUENESS AND HANDMADE. THE THIRD MATERIAL IS CEMENT, USED TO MAKE THE CANOPIES, THE TRACKS AND THE BASES OF THE FLOOR LAMP, THE ELEMENTS THAT DIRECTLY TOUCH THE STRUCTURE OF OUR ENVIRONMENTS. THE CRAFTSMANSHIP OF THE PROCESS OF MAKING CONCRETE ELEMENTS MEANS THAT EACH PIECE IS UNIQUE, DIFFERENT FROM ALL OTHERS AS A SURFACE FINISH AND EMBELLISHED WITH TYPICAL DETAILS OF CEMENT MORTARS, SUCH AS GRAIN AND MICROPOROSITY. INTI IS A MIX OF TRADITIONAL CRAFTSMANSHIP AND TECHNOLOGICAL INNOVATION, THE ENTIRE FAMILY HAS BEEN DESIGNED AND BUILT IN ITALY, COMBINING ARTISAN KNOWLEDGE WITH CUTTING-EDGE PROCESSING METHODS, SUCH AS 3D PRINTING AND RAPID PROTOTYPING.

INTI WAR DIE INKA-GOTTHEIT DER SONNE, EINES TAGES BEFAHL ER SEINEN SÖHNEN, DIE HAUPTSTADT DES KÖNIGREICHS ZU BAUEN. SIE MÜSSTEN DIE ERDE MIT EINEM GÖTTLICHEN GOLDSTAB DURCHWANDERN UND MÜSSTEN ES AN DEN ORT LEGEN, DER FÜR DIE ERSCHAFFUNG DER STADT VORBESTIMMT WAR. SO WURDE CUZCO GEBOREN UND DIE INKA-ZIVILISATION ENTWICKELTE SICH. ICH BEGANN MIT DIESEM MYTHOS ALS INSPIRATION FÜR DIE NEUE PRODUKTFAMILIE FÜR CANGINI UND TUCCI. DIE WAHL DER MATERIALIEN WAR GRUNDLEGENDE FÜR DIE ENTWICKLUNG DER LINIE. ICH WÄHLTE MESSING ALS STRUKTURELEMENT FÜR DIE GANZE FAMILIE UND ENTWICKELTE ES IN DREI AUSFÜHRUNGSVARIANTEN: GEBÜRSTET, BRÜNIERT UND VERKUPFERT. DAS GLAS WURDE MIT EINER VERLAUFSFARBE BEHANDELT, DIE VON OPAK WEISS BIS TRANSPARENT REICHT, UM BLENDUNGEN BEIM DIREKTEN BLICK AUF DIE LAMPE ZU VERMEIDEN. DIESER PROZESS, SOWIE DIE ENTWICKLUNG ALLER CANGINI UND TUCCI GLÄSER, WIRD KOMPLETT VON HAND GEMACHT UND MACHT JEDES PRODUKT ANDERS ALS DIE ANDEREN.

ES ERZÄHLT EINE GESCHICHTE VON HANDWERKSKUNST, LIEBE ZUM DETAIL UND DIREKTE BEZIEHUNG ZWISCHEN MEISTER GEBLÄSE UND GLAS. JEDE UNVOLLKOMMENHEIT DES FINISHS GILT ALS GRUNDPFILER DIESER GESCHICHTE, DENN MADE IN ITALY BEDEUTET FÜR UNS VOR ALLEM EINZIGARTIGKEIT UND HANDARBEIT. DAS DRITTE MATERIAL IST ZEMENT, DER FÜR DIE HERSTELLUNG DER ROSETTEN, DER SCHIENEN UND DER SOCKEL DER STEHLEUCHTE VERWENDET WIRD, DIE DIE STRUKTUR DES HAUSES DIREKT BERÜHREN. DIE KUNSTFERTIGKEIT DES HERSTELLUNGSPROZESSES VON BETONELEMENTEN BEDEUTET, DASS JEDES STÜCK EINZIGARTIG IST, SICH VON ALLEN ANDEREN ALS OBERFLÄCHE UNTERSCHIEDET UND MIT TYPISCHEN DETAILS VON ZEMENTMÖRTELN WIE KORN UND MICROPOROSITÄT VERSEHEN IST. INTI IST EINE MISCHUNG AUS TRADITIONELLER HANDWERKSKUNST UND TECHNOLOGISCHER INNOVATION. DIE GESAMTE FAMILIE WURDE IN ITALIEN ENTWORFEN UND GEBAUT UND VERBINDET HANDWERKLICHES WISSEN MIT MODERNSTEN VERARBEITUNGSMETHODEN WIE 3D-DRUCK UND RAPID PROTOTYPING.



INTI

Design Alberto Manzoni
Labomaki Studio - Cesena



**LAMPADA APPLIQUE, SOSPENSIONE,
BINARIO, PLAFONIERA E PIANTANA**

*WALL LAMP, HANGING LAMP, CEILING TRACK
CEILING LAMP AND FLOOR LAMP*



XXL1463.1L



1460.2L



AP1460.2L

INTI

STRUTTURA IN OTTONE DISPONIBILE / BRASS STRUCTURE AVAILABLE:

OTTONE SPAZZOLATO / BRUSHED BRASS (01)

BRONZO SPAZZOLATO / BRUSHED BRONZE (02)

ULTERIORI COMPOSIZIONI A RICHIESTA
ADDITIONAL COMPOSITIONS ON DEMAND

ROSONI IN CEMENTO - CAVO NERO IN GOMMA
CEMENT CANOPIES - BLACK RUBBER CABLE

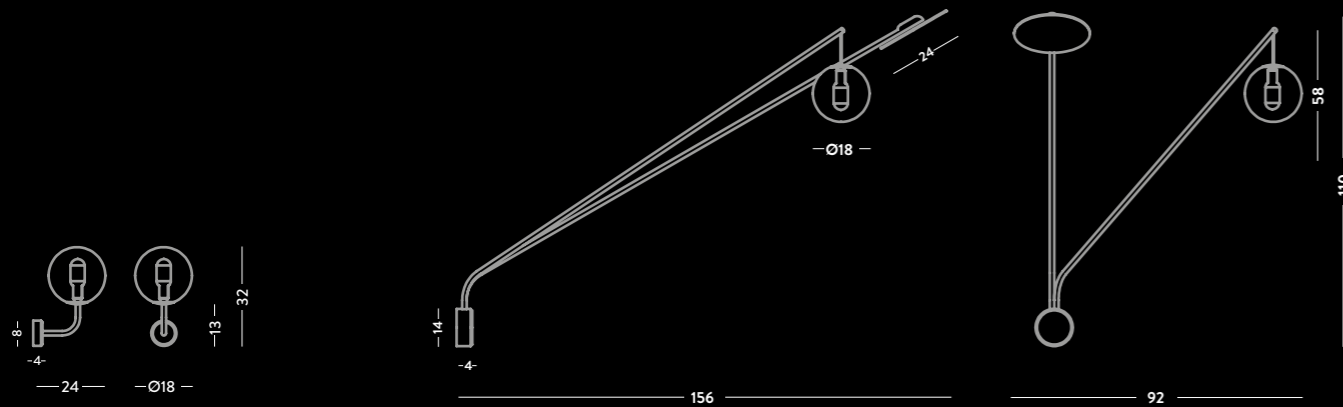

AP1461.1L

Applique / Wall lamp

L18 cm - P24 cm - H32 cm

1 E14 x max 42W 220-240V

CE IP20 1m

AP1460.2L

Applique / Wall lamp

L92 cm - P156 cm - H110 cm

1 E14 x max 42W 220 - 240V

1 x LED 8,7W - 2700 K - 530 lm* - 230V

Dimmerabilità a taglio di fase / Dimmer Triac

CE IP20 1m

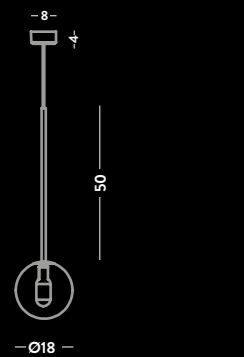

1463.1L

Sospensione / Hanging lamp

vetro/glass Ø18 cm - cavo/cable 150 cm

1 E14 x max 42W 220-240V

CE IP20 1m



GIG1463.1L

Sospensione / Hanging lamp

vetro/glass Ø24 cm - cavo/cable 150 cm

1 E27 x max 70W 220-240V

CE IP20 1m



XXL1463.1L

Sospensione / Hanging lamp

vetro/glass Ø30 cm - cavo/cable 150 cm

1 E27 x max 70W 220-240V

CE IP20 1m

COLORI VETRO DISPONIBILI / AVAILABLE GLASS COLOURS



01 - Trasparente
Transparent

05 - Ambra
Amber

16 - Tabacco
Tobacco

Bianco satinato
Satin white

STRUTTURA IN OTTONE DISPONIBILE / AVAILABLE BRASS STRUCTURE

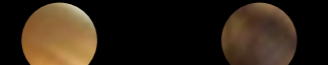

01 - Ottone spazzolato
Brushed brass

02 - Bronzo spazzolato
Brushed bronze



1469MX.3L

Plafoniera / Ceiling lamp

vetro/glass Ø18/24/30 cm - cavo/cable 150 cm

1 E14 x max 42W 2 E27 x max 70W 220-240V

CE IP20 1m

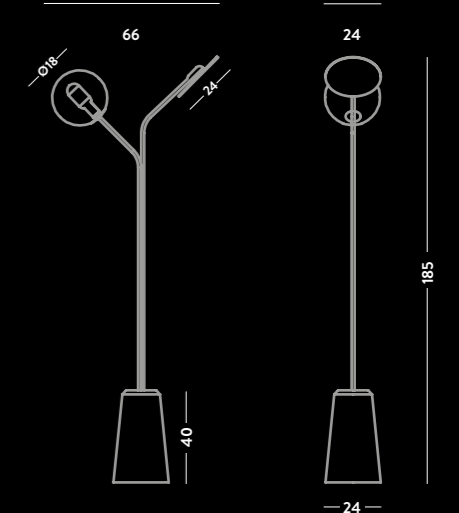

1460.2L

Piantana / Floor lamp

L24 - P66 - H185 cm

1 E14 x max 42W 220 - 240V

1 x LED 8,7W - 2700 K - 530 lm* - 230V

Dimmerabilità a taglio di fase / Dimmer Triac

CE IP20 1m

PER UNA LUCE DIFFUSA UNIFORME CONSIGLIAMO LAMPADINE OPALINE A LED TIPO PHILIPS 75W 2.700K
FOR A UNIFORM DIFFUSED LIGHT WE RECOMMEND OPAL LIGHT LED BULBS LIKE PHILIPS 75W 2,700K

I LUMEN INDICATI CORRISPONDONO ALL'INTENSITÀ
LUMINOSA ALL'ORIGINE DELLA SCHEDA LED
LUMEN INDICATED CORRESPONDS TO THE LUMINOUS
INTENSITY AT THE ORIGIN OF THE LED BOARD



FIJI®

design, Enrico De Lotto

**LAMPADA APPLIQUE,
SOSPENSIONE, E PLAFONIERA**

*WALL LAMP, HANGING LAMP
AND CEILING LAMP*



ROSONE CON ALL'INTERNO MECCANISMO
UP E DOWN DOTATO DI AVVOLGICAVO

CANOPY EQUIPPED WITH CABLE REEL
UP&DOWN INSIDE MECHANISM



DOWN



UP



GIG1483.1L



GIG1483.1L



1487.120.3L



FIJI®

STRUTTURA METALLICA DISPONIBILE / AVAILABLE METAL STRUCTURE:
CROMO/CHROME - NERO/BLACK

ULTERIORI COMPOSIZIONI A RICHIESTA
ADDITIONAL COMPOSITIONS ON DEMAND

CASAMBI

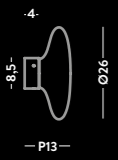

AP1481.1L

Applique / Wall lamp

Ø26 cm - P13 cm

1 x LED 12,8W 32 - 40V CC 350mA
Dimmerabilità a taglio di fase / Dimmer Triac

CE IP20 Δ 1m

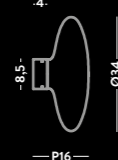

APGIG1481.1L

Applique / Wall lamp

Ø34 cm - P16 cm

1 x LED 12,8W 32 - 40V CC 350mA
Dimmerabilità a taglio di fase / Dimmer Triac

CE IP20 Δ 1m

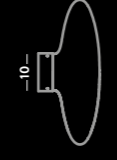

APXXL1481.1L

Applique / Wall lamp

Ø40 cm - P17 cm

1 x LED 12,8W 32 - 40V CC 350mA
Dimmerabilità a taglio di fase / Dimmer Triac

CE IP20 Δ 1m

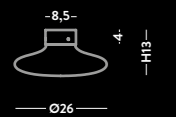

1482.1L

Plafoniera / Ceiling lamp

Ø26 cm - H13 cm

1 x LED 12,8W 32 - 40V CC 350mA
Dimmerabilità a taglio di fase / Dimmer Triac

CE IP20 Δ 1m

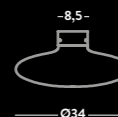

GIG1482.1L

Plafoniera / Ceiling lamp

Ø34 cm - H16 cm

1 x LED 12,8W 32 - 40V CC 350mA
Dimmerabilità a taglio di fase / Dimmer Triac

CE IP20 Δ 1m

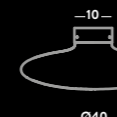

XXL1482.1L

Plafoniera / Ceiling lamp

Ø40 cm - H17 cm

1 x LED 12,8W 32 - 40V CC 350mA
Dimmerabilità a taglio di fase / Dimmer Triac

CE IP20 Δ 1m



1486.1L

Plafoniera / Ceiling lamp

Ø28 cm - H13 cm

1 x LED 12,8W 32 - 40V CC 350mA
Dimmerabilità a taglio di fase / Dimmer Triac

CE IP20 Δ 1m

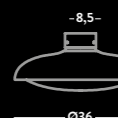

GIG1486.1L

Plafoniera / Ceiling lamp

Ø36 cm - H16 cm

1 x LED 12,8W 32 - 40V CC 350mA
Dimmerabilità a taglio di fase / Dimmer Triac

CE IP20 Δ 1m

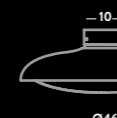

XXL1486.1L

Plafoniera / Ceiling lamp

Ø46 cm - H17 cm

1 x LED 12,8W 32 - 40V CC 350mA
Dimmerabilità a taglio di fase / Dimmer Triac

CE IP20 Δ 1m

COLORI VETRO DISPONIBILI / AVAILABLE GLASS COLOURS

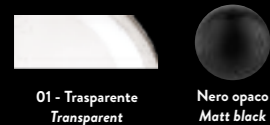
01 - Trasparente
TransparentNero opaco
Matt black

COLORI VETRO METALLIZZATO DISPONIBILI / METALLIC GLASS COLOURS AVAILABLE

Oro rosa
Rose goldAcciaio
SteelMiele
Honey

AVAILABLE WITH UP & DOWN SYSTEM
DISPONIBILE ANCHE CON SISTEMA UP&DOWN



1483.1L

Sospensione / Hanging lamp

vetro/glass Ø28 cm - cavo/cable 150 cm

1 x LED 12,8W 32 - 40V CC 350mA
Dimmerabilità a taglio di fase / Dimmer Triac

CE IP20 Δ 1m

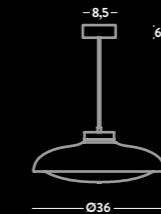

GIG1483.1L

Sospensione / Hanging lamp

vetro/glass Ø36 cm - cavo/cable 150 cm

1 x LED 12,8W 32 - 40V CC 350mA
Dimmerabilità a taglio di fase / Dimmer Triac

CE IP20 Δ 1m

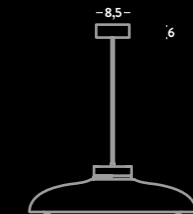

XXL1483.1L

Sospensione / Hanging lamp

vetro/glass Ø46 cm - cavo/cable 150 cm

1 x LED 12,8W 32 - 40V CC 350mA
Dimmerabilità a taglio di fase / Dimmer Triac

CE IP20 Δ 1m

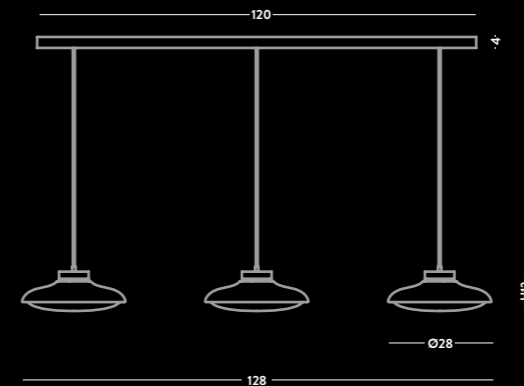

1487.120.3L

Binario a soffitto / Ceiling track

L128 - P28 cm - cavo/cable 150 cm

3 x LED 12,8W 32 - 40V CC 350mA

Dimmerabilità a taglio di fase / Dimmer Triac

CE IP20 Δ 1m

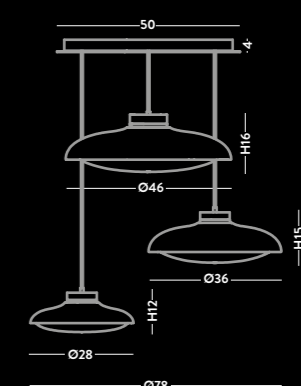

1489MX.50.3L

Plafoniera / Ceiling lamp

Ø78 cm - cavo/cable 150 cm

3 x LED 12,8W 32 - 40V CC 350mA

Dimmerabilità a taglio di fase / Dimmer Triac

CE IP20 Δ 1m

1487.120.3L
BINARIO / CEILING TRACK:
ACCIAIO INOX RILUCIDATO / STAINLESS POLISHED STEEL

1489MX.50.3L
PLAFONIERA / CEILING LAMP:
ACCIAIO INOX RILUCIDATO / STAINLESS POLISHED STEEL

- COMPATIBILE CON CASAMBI / COMPATIBLE WITH CASAMBI
- CAVO ELETTRICO IN GOMMA NERO / BLACK RUBBER ELECTRIC CABLE
- DIFFUSORE IN VETRO SABBIAIO / DIFFUSER IN SANDED GLASS
- DRIVER INCLUSO / DRIVER INCLUDED
- DIMMERABILE: SÌ - SCHEDA LED SOSTITUIBILE DA PROFESSIONISTA
DIMMABLE: YES - LED IS REPLACEABLE BY PROFESSIONAL

LED 12,8W Dimmer Triac - 1615 Lm -126 Lm/W - IP20 - CC 350mA - CRI Typ.95 - 32-40V - 180° - 2700°K O/OR 3000°K
A RICHIESTA: COMPONENTI UL +10% / ON DEMAND: UL COMPONENTS +10%

I LUMEN INDICATI CORRISPONDONO ALL'INTENSITÀ LUMINOSA
ALL'ORIGINE DELLA SCHEDA LED
LUMEN INDICATED CORRESPONDS TO THE LUMINOUS INTENSITY
AT THE ORIGIN OF THE LED BOARD



SCARLETT

design, Alberto Manzoni e Pietro Tucci

LAMPADA APPLIQUE E
SOSPENSIONE

HANGING AND WALL LAMP





AP1491.1L

SCARLETT

STRUTTURA IN OTTONE DISPONIBILE

BRASS STRUCTURE AVAILABLE:

OTTONE SPAZZOLATO / BRUSHED BRASS (01)

BRONZO SPAZZOLATO / BRUSHED BRONZE (02)

ULTERIORI COMPOSIZIONI A RICHIESTA
ADDITIONAL COMPOSITIONS ON DEMAND

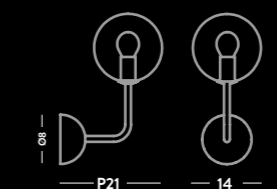

AP1491.1L

Applique / Wall lamp

L14 cm - P21 - H30 cm

1 E14 x max 42W 220-240V

CE IP20 (1m)

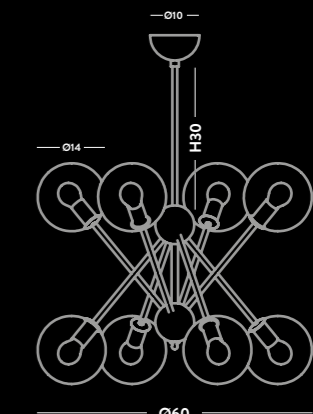

1493.4+4/8L

Lampadario / Chandelier

Ø60 cm - H72 cm

8 E14 x max 42W 220-240V

CE IP20 (1m)

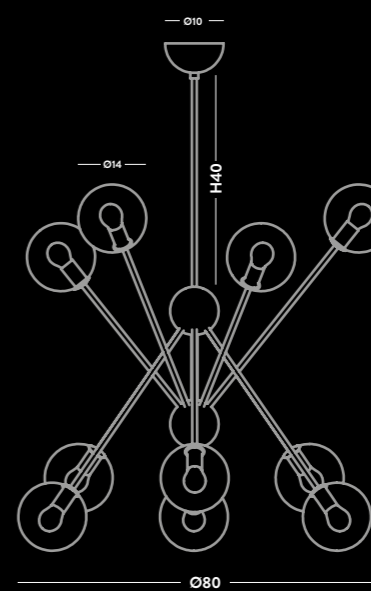

1493.6+6/12L

Lampadario / Chandelier

Ø80 cm - H98 cm

12 E14 x max 42W 220-240V

CE IP20 (1m)

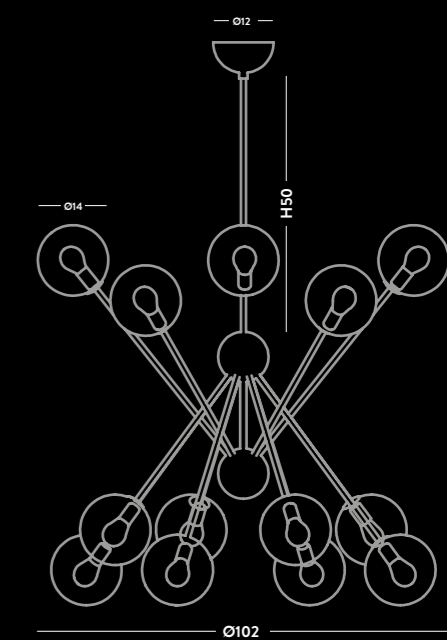

1493.8+8/16L

Lampadario / Chandelier

Ø102 cm - H114 cm

16 E14 x max 42W 220-240V

CE IP20 (1m)

COLORI VETRO DISPONIBILI / AVAILABLE GLASS COLOURS



01 - Trasparente
Transparent

05 - Ambra
Amber

16 - Tabacco
Tobacco

Bianco satinato
Satin white

STRUTTURA IN OTTONE DISPONIBILE / AVAILABLE BRASS STRUCTURE

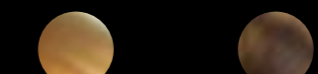

01 - Ottone spazzolato
Brushed brass

02 - Bronzo spazzolato
Brushed bronze



AUF

design, Alberto Manzoni

**LAMPADA A SOSPENSIONE,
BINARIO E PLAFONIERA**

*HANGING LAMP,
CEILING TRACK AND CEILING LAMP*



AUFMX.43.3L



AUF.1L



1419.43.3L



1447.120.3L

AUF

STRUTTURA METALLICA DISPONIBILE
AVAILABLE METAL STRUCTURE:
NERO / BLACK

LED DISPONIBILI PER LA LINEA
AUF LEDS AVAILABLE FOR AUF

Dimmerabile: Sì - Scheda LED
sostituibile da professionista
Dimmable: Yes - LED
is replaceable by professional

LED 15W Dimmer Triac - 1275 Lm - 85 Lm/W - IP20
CRI 90+ - 230V - 3 step MacAdam - 2700°K
LED 15W Dimmer Triac - 1350 Lm - 90 Lm/W - IP20
CRI 90+ - 230V - 3 step MacAdam - 3000°K

I LUMEN INDICATI CORRISPONDONO ALL'INTENSITÀ
LUMINOSA ALL'ORIGINE DELLA SCHEDA LED
LUMEN INDICATED CORRESPONDS TO THE LUMINOUS
INTENSITY AT THE ORIGIN OF THE LED BOARD



TUBA

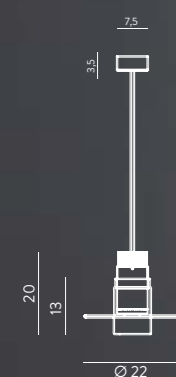

1403.1L

Sospensione / Hanging lamp
vetro/glass Ø22 cm - cavo/cable 150 cm

1 x LED 15W - 3000 K - 1350 lm - 230V
Dimmerabilità a taglio di fase / Dimmer Triac

CE IP20 Δ 1m

LABO



1443.1L

Sospensione / Hanging lamp
vetro/glass Ø21 cm - cavo/cable 150 cm

1 x LED 15W - 3000 K - 1350 lm - 230V
Dimmerabilità a taglio di fase / Dimmer Triac

CE IP20 Δ 1m

MINI BUATTA



1413.1L

Sospensione / Hanging lamp
vetro/glass Ø19 cm - cavo/cable 150 cm

1 x LED 15W - 3000 K - 1350 lm - 230V
Dimmerabilità a taglio di fase / Dimmer Triac

CE IP20 Δ 1m

COLORI VETRO DISPONIBILI / AVAILABLE GLASS COLOURS



01 - Trasparente
Transparent

05 - Ambra
Amber

16 - Tabacco
Tobacco

COLORI VETRO METALLIZZATO DISPONIBILI / METALLIC GLASS COLOURS AVAILABLE



Oro rosa
Rose gold

AUF

STRUTTURA METALLICA DISPONIBILE / AVAILABLE METAL STRUCTURE:
- NERO / BLACK

ULTERIORI COMPOSIZIONI A RICHIESTA
ADDITIONAL COMPOSITIONS ON DEMAND

LED DISPONIBILI PER LA LINEA
AUF LEDS AVAILABLE FOR AUF

Dimmerabile: Sì - Scheda LED
sostituibile da professionista
Dimmable: Yes - LED
is replaceable by professional

LED 15W Dimmer Triac - 1275 Lm - 85 Lm/W - IP20
CRI 90+ - 230V - 3 step MacAdam - 2700°K
LED 15W Dimmer Triac - 1350 Lm - 90 Lm/W - IP20
CRI 90+ - 230V - 3 step MacAdam - 3000°K

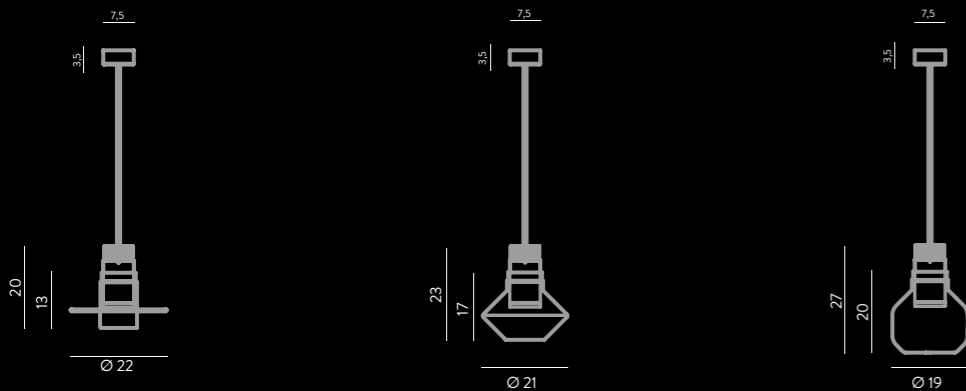

1403.1L

Sospensione / Hanging lamp

vetro/glass Ø22 cm - cavo/cable 150 cm

1 x LED 15W - 3000 K - 1350 lm - 230V
Dimmerabilità a taglio di fase / Dimmer Triac

CE IP20 Δ 1m

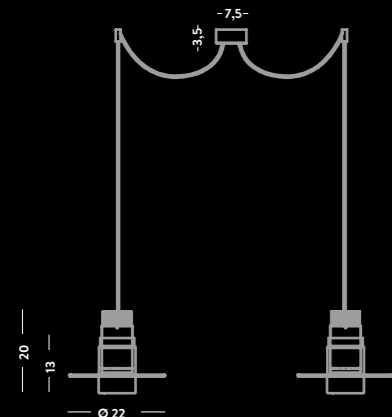

1403.2L

Sospensione / Hanging lamp

vetro/glass Ø22 cm - cavo/cable 150 cm

2 x LED 15W - 3000 K - 1350 lm - 230V
Dimmerabilità a taglio di fase / Dimmer Triac

CE IP20 Δ 1m

1443.1L

Sospensione / Hanging lamp

vetro/glass Ø21 cm - cavo/cable 150 cm

1 x LED 15W - 3000 K - 1350 lm - 230V
Dimmerabilità a taglio di fase / Dimmer Triac

CE IP20 Δ 1m

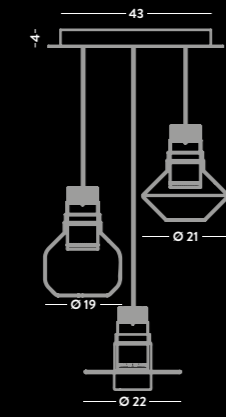

AUFMX.43.3L

Sospensione / Hanging lamp

vetro/glass Ø22/21/19 cm - cavo/cable 150 cm

3 x LED 15W - 3000 K - 1350 lm - 230V
Dimmerabilità a taglio di fase / Dimmer Triac

CE IP20 Δ 1m

1413.1L

Sospensione / Hanging lamp

vetro/glass Ø19 cm - cavo/cable 150 cm

1 x LED 15W - 3000 K - 1350 lm - 230V
Dimmerabilità a taglio di fase / Dimmer Triac

CE IP20 Δ 1m



AUF.1L

Sospensione / Hanging lamp

cilindro/cylinder Ø7,5 H15 cm - cavo/cable 150 cm

1 x LED 15W - 3000 K - 1350 lm - 230V
Dimmerabilità a taglio di fase / Dimmer Triac

CE IP20 Δ 1m

CAVO IN TESSUTO DISPONIBILE
FABRIC CABLE AVAILABLE



Nero
Black

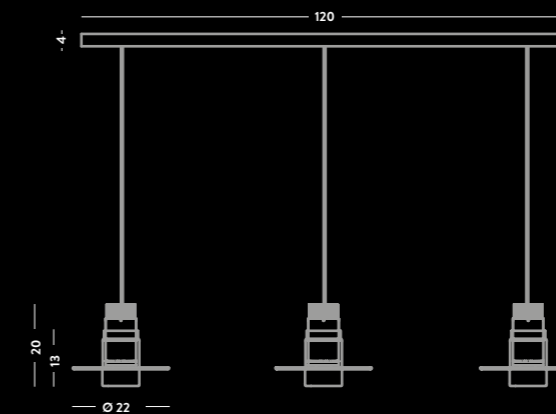

1407.120.3L

Binario a soffitto / Ceiling track

vetro/glass Ø22 cm - cavo/cable 150 cm

3 x LED 15W - 3000 K - 1350 lm - 230V
Dimmerabilità a taglio di fase / Dimmer Triac

CE IP20 Δ 1m

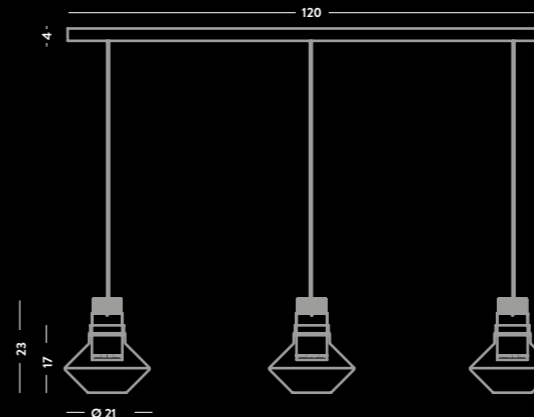

1447.120.3L

Binario a soffitto / Ceiling track

vetro/glass Ø21 cm - cavo/cable 150 cm

3 x LED 15W - 3000 K - 1350 lm - 230V
Dimmerabilità a taglio di fase / Dimmer Triac

CE IP20 Δ 1m

1447.120.3L
BINARIO / CEILING TRACK:
ACCIAIO INOX RILUCIDATO / STAINLESS POLISHED STEEL

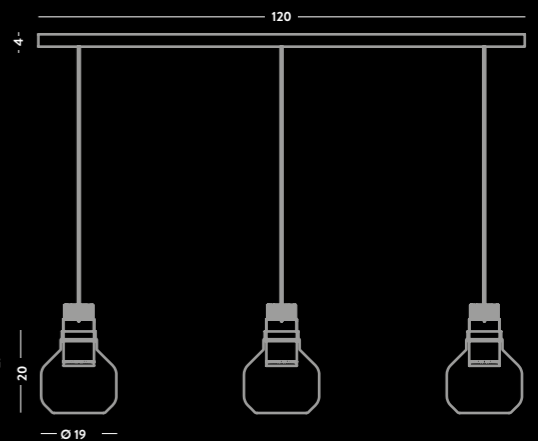

1417.120.3L

Binario a soffitto / Ceiling track

vetro/glass Ø19 cm - cavo/cable 150 cm

3 x LED 15W - 3000 K - 1350 lm - 230V
Dimmerabilità a taglio di fase / Dimmer Triac

CE IP20 Δ 1m

COLORI VETRO DISPONIBILI / AVAILABLE GLASS COLOURS

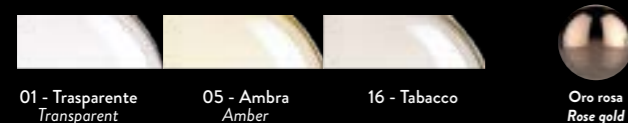

01 - Trasparente
Transparent

05 - Ambra
Amber

16 - Tabacco
Tobacco

Oro rosa
Rose gold

I LUMEN INDICATI CORRISPONDONO ALL'INTENSITÀ LUMINOSA
ALL'ORIGINE DELLA SCHEDA LED
LUMEN INDICATED CORRESPONDS TO THE LUMINOUS INTENSITY
AT THE ORIGIN OF THE LED BOARD



DOLIUM

**LAMPADA APPLIQUE, SOSPENSIONE,
BINARIO E PLAFONIERA**

*WALL LAMP, HANGING LAMP,
CEILING TRACK AND CEILING LAMP*



GIG1367.3L







AP1361.1L

DOLIUM

STRUTTURA IN OTTONE DISPONIBILE
BRASS STRUCTURE AVAILABLE:
- CROMATO / CROME

ULTERIORI COMPOSIZIONI A RICHIESTA
ADDITIONAL COMPOSITIONS ON DEMAND

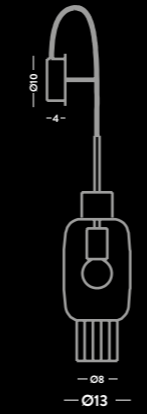

AP1361.1L

Applique / Wall lamp
vetro/glass Ø13 cm - cavo/cable 50 cm
1 E27 x max 42W 220-240V
CE IP20 1m



1363.1L

Sospensione / Hanging lamp
vetro/glass Ø13 cm - cavo/cable 150 cm
1 E27 x max 42W 220-240V
CE IP20 1m

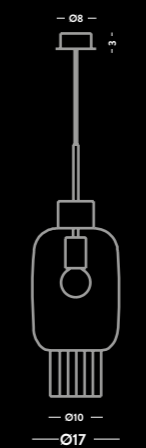

GIG1363.1L

Sospensione / Hanging lamp
vetro/glass Ø17 cm - cavo/cable 150 cm
1 E27 x max 70W 220-240V
CE IP20 1m

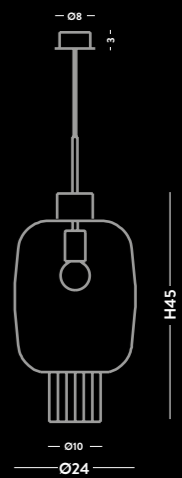

XXL1363.1L

Sospensione / Hanging lamp
vetro/glass Ø24 cm - cavo/cable 150 cm
1 E27 x max 70W 220-240V
CE IP20 1m

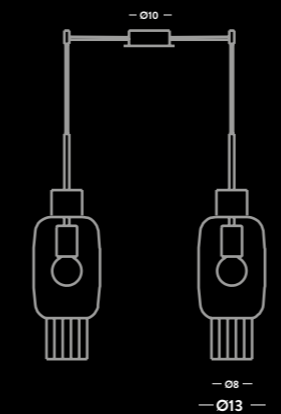

1363.2L

Sospensione / Hanging lamp
vetro/glass Ø13 cm - cavo/cable 250 cm
2 E27 x max 42W 220-240V
CE IP20 1m

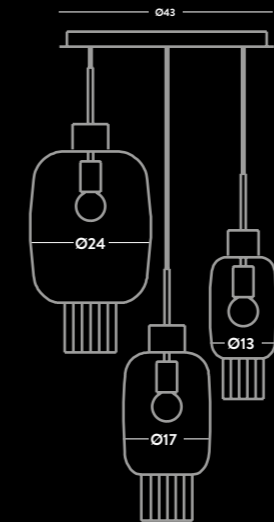

1369MX.3L

Plafoniera / Ceiling lamp
vetro/glass Ø13/17/24 cm - cavo/cable 150 cm
1 E27 x max 42W
2 E27 x max 70W 220-240V
CE IP20 1m

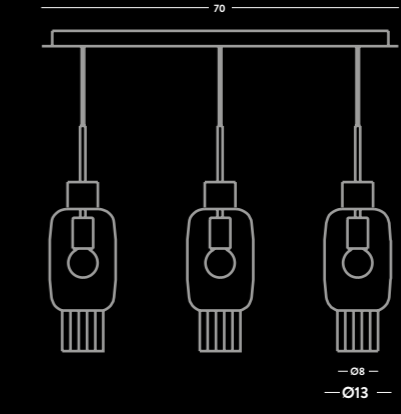

1367.3L

Binario a soffitto / Ceiling track
vetro/glass Ø13 cm - cavo/cable 150 cm
3 E27 x max 42W 220-240V
CE IP20 1m

1369MX.3L - 1367.3L
BINARIO E PLAFONIERA / CEILING TRACK AND CEILING LAMP:
ACCIAIO INOX RILUCIDATO / STAINLESS POLISHED STEEL

LEGNI DISPONIBILI
WOOD AVAILABLE



A richiesta senza elemento in legno
On demand without wood element

COLORI METALLIZZATI
VETRO DISPONIBILI
METALLIC GLASS COLOURS
AVAILABLE



Oro rosa
Rose gold

Titanio
Titanium

COLORI VETRO DISPONIBILI / AVAILABLE GLASS COLOURS



01 - Trasparente
Transparent

03 - Rosa
Pink

05 - Ambra
Amber

06 - Verde
Green

07 - Azzurro
Sky-blue

08 - Fumè
Fume

16 - Tabacco
Tobacco

17 - Rubino
Ruby

ARTICOLI GIG E XXL NEL COLORE FUMÈ: SUPPLEMENTO DEL 10% SUL PREZZO DEL COLORATO / PRODUCTS GIG AND XXL IN FUME COLOR: 10% SURCHARGE ON THE PRICE OF THE COLOURED



TAO

**LAMPADA DA TAVOLO, APPLIQUE,
SOSPENSIONE, BINARIO E PLAFONIERA**

*TABLE LAMP, WALL LAMP, HANGING LAMP,
CEILING TRACK AND CEILING LAMP*



GIG1389.3L



1387.7L



1385.3L



AP1381.1L



LU1380.1L



TAO

STRUTTURA METALLICA DISPONIBILE / AVAILABLE METAL STRUCTURE:
CROMO/CHROME

ULTERIORI COMPOSIZIONI A RICHIESTA
ADDITIONAL COMPOSITIONS ON DEMAND

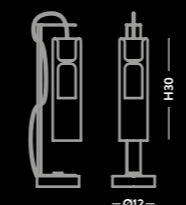

LU1380.1L
Lumetto / Table lamp
vetro/glass Ø8 cm - H46 cm
G9 x max 33W 230V
CE IP20 1m

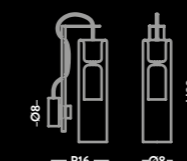

AP1381.1L
Applique / Wall lamp
vetro/glass Ø8 cm - cavo/cable 50 cm
1 G9 x max 33W 230V
CE IP20 1m



1383.1L
Sospensione / Hanging lamp
vetro/glass Ø8 cm - cavo/cable 150 cm
1 G9 x max 33W 230V
CE IP20 1m

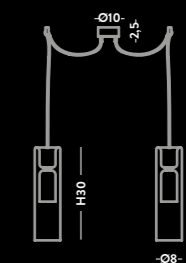

1383.2L
Sospensione / Hanging lamp
vetro/glass Ø8 cm - cavo/cable 250 cm
2 G9 x max 33W 230V
CE IP20 1m

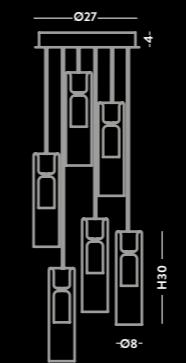

1389.6L
Plafoniera / Ceiling lamp
vetro/glass Ø8 cm - cavo/cable 150 cm
6 G9 x max 33W 230V
CE IP20 1m

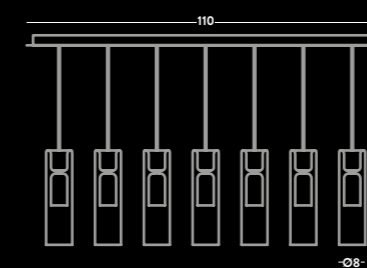

1387.7L
Binario a soffitto / Ceiling track
vetro/glass Ø8 cm - cavo/cable 150 cm
7 G9 x max 33W 230V
CE IP20 1m

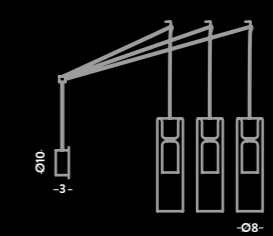

1385.3L
Sospensione / Hanging lamp
vetro/glass Ø8 cm - cavo/cable 250 cm
3 G9 x max 33W 230V
CE IP20 1m



GIG1383.1L
Sospensione / Hanging lamp
vetro/glass Ø10 cm - cavo/cable 150 cm
1 E27 x max 70W 220-240V
CE IP20 1m

1389.6L - 1387.7L
BINARIO E PLAFONIERA
CEILING TRACK AND CEILING LAMP:
ACCIAIO INOX RILUCIDATO
STAINLESS POLISHED STEEL

COLORI METALLIZZATI VETRO DISPONIBILI / METALLIC GLASS COLOURS AVAILABLE

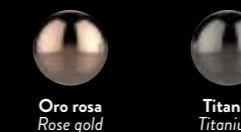

COLORI VETRO DISPONIBILI / AVAILABLE GLASS COLOURS

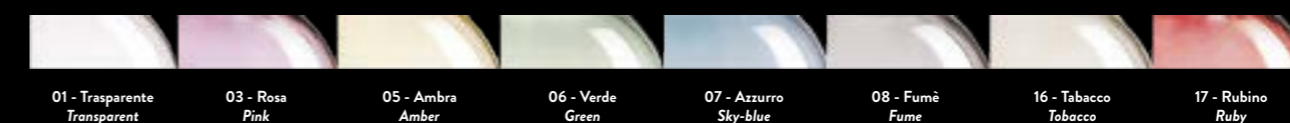

ARTICOLI GIG NEL COLORE FUMÈ: SUPPLEMENTO DEL 10% SUL PREZZO DEL COLORATO / PRODUCTS GIG IN FUME COLOR: 10% SURCHARGE ON THE PRICE OF THE COLOURED



ECLISSE

**LAMPADA DA TAVOLO, APPLIQUE,
SOSPENSIONE E PLAFONIERA**

*TABLE LAMP, WALL LAMP,
HANGING LAMP AND CEILING LAMP*







ECLISSE

STRUTTURA METALLICA DISPONIBILE / AVAILABLE METAL STRUCTURE:
CROMO/CHROME

ULTERIORI COMPOSIZIONI A RICHIESTA
ADDITIONAL COMPOSITIONS ON DEMAND

CAVI IN SILICONE DISPONIBILI /
SILICONE CABLES AVAILABLE



S1290.1L
Lumetto / Table lamp
vetro/glass Ø14 cm - H20 cm
1 G9 x max 33W 230V
IP20

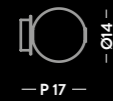

APS1291.1L
Applique / Wall lamp
vetro/glass Ø14 cm - P17 cm
1 G9 x max 33W 230V
IP20



1293.1L
Sospensione / Hanging lamp
vetro/glass Ø14 cm - cavo/cable 150 cm
1 G9 x max 33W 230V
IP20

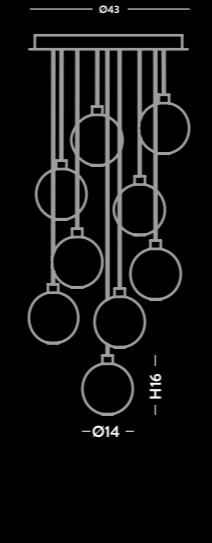

1299.9L
Plafoniera / Ceiling lamp
vetro/glass Ø14 cm - cavo/cable 150 cm
9 G9 x max 33W 230V
IP20

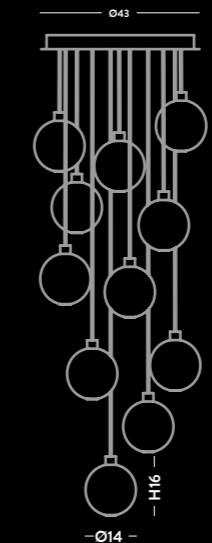

1299.11L
Plafoniera / Ceiling lamp
vetro/glass Ø14 cm - cavo/cable 150 cm
11 G9 x max 33W 230V
IP20

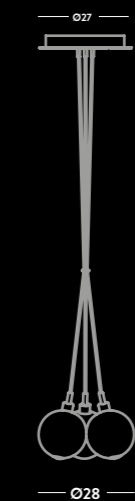

1292.3L
Plafoniera / Ceiling lamp
vetro/glass Ø14 cm - cavo/cable 150 cm
3 G9 x max 33W 230V
IP20

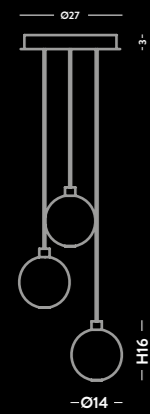

1299.3L
Plafoniera / Ceiling lamp
vetro/glass Ø14 cm - cavo/cable 150 cm
3 G9 x max 33W 230V
IP20

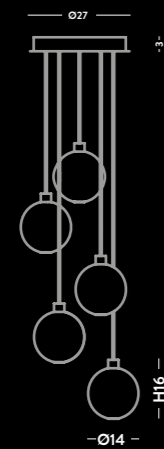

1299.5L
Plafoniera / Ceiling lamp
vetro/glass Ø14 cm - cavo/cable 150 cm
5 G9 x max 33W 230V
IP20

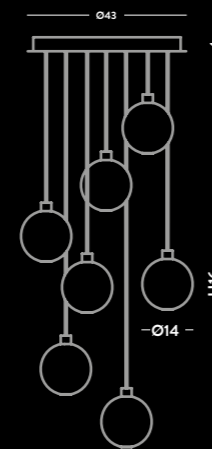

1299.7L
Plafoniera / Ceiling lamp
vetro/glass Ø14 cm - cavo/cable 150 cm
7 G9 x max 33W 230V
IP20

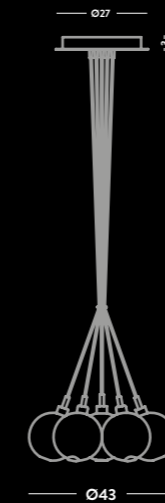

1292.7L
Plafoniera / Ceiling lamp
vetro/glass Ø14 cm - cavo/cable 150 cm
7 G9 x max 33W 230V
IP20

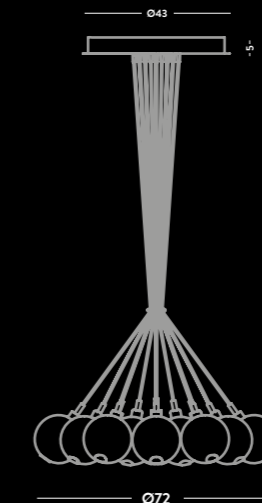

1292.19L
Plafoniera / Ceiling lamp
vetro/glass Ø14 cm - cavo/cable 250 cm
19 G9 x max 33W 230V
IP20

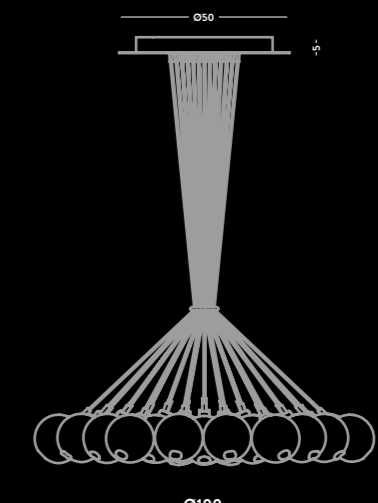

1292.37L
Plafoniera / Ceiling lamp
vetro/glass Ø14 cm - cavo/cable 250 cm
37 G9 x max 33W 230V
IP20

1299.9L - 1299.11L - 1292.3L
1292.7L - 1292.19L - 1292.37L
1299.3L - 1299.5L - 1299.7
PLAFONIERA / CEILING LAMP,
ACCIAIO INOX RILUCIDATO
STAINLESS POLISHED STEEL

COLORI VETRO DISPONIBILI / AVAILABLE GLASS COLOURS



COLORI VETRO METALLIZZATO DISPONIBILI / METALLIC GLASS COLOURS AVAILABLE

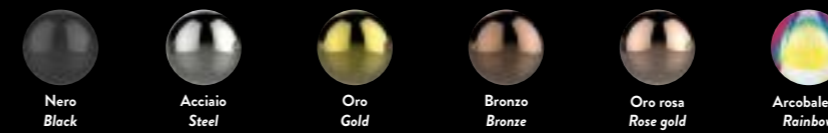



PARIGI

**LAMPADA DA TAVOLO, APPLIQUE,
SOSPENSIONE E PLAFONIERA**

*TABLE LAMP, WALL LAMP,
HANGING LAMP, AND CEILING LAMP*



XXL1203.1L



RGIG1213.1L



R1209MX.3L



LUGIG1203

LU1203

LUXXL1203

PARALUMI LINO OLANDA DISPONIBILI PER LA LINEA PARIGI / LINO OLANDA LAMPSHADES AVAILABLE FOR PARIGI



LI - Bianco
LI - White



LI - Panna
LI - Cream



LI - Tortora
LI - Dove gray



GOCCIA

**LAMPADA DA TAVOLO, APPLIQUE,
SOSPENSIONE, BINARIO E PLAFONIERA**

*TABLE LAMP, WALL LAMP, HANGING LAMP,
CEILING TRACK AND CEILING LAMP*



GIG803.1L



MED803.1L



806.1L



AP801.1L

GOCCIA

STRUTTURA METALLICA DISPONIBILE / AVAILABLE METAL STRUCTURE

- CROMO, ORO (A RICHIESTA: FOGLIA ORO/ARGENTO)
CHROME, GOLD (ON DEMAND: GOLD/SILVER LEAF)

ULTERIORI COMPOSIZIONI A RICHIESTA
ADDITIONAL COMPOSITIONS ON DEMAND

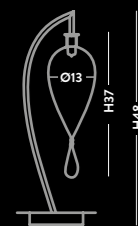

— Ø20 —

LU804.1L

Lumetto / Table lamp

vetro/glass Ø13 cm - H 48 cm

1 G9 x max 42W 230V

CE IP20 1m

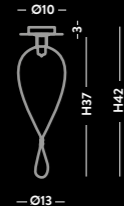

806.1L

Plafoniera / Ceiling lamp

vetro/glass Ø13 cm - H 42 cm

1 G9 x max 42W 230V

CE IP20 1m

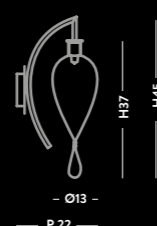

AP804.1L

Applique / Wall lamp

vetro/glass Ø13 cm - H 45 cm

1 G9 x max 42W 230V

CE IP20 1m

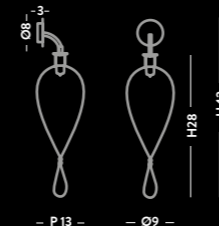

AP801.1L

Applique / Wall lamp

vetro/glass Ø9 cm - H 42 cm

1 G9 x max 42W 230V

CE IP20 1m

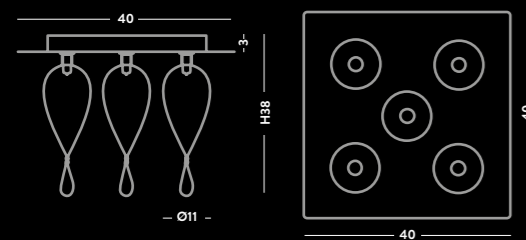

809.5L

Plafoniera / Ceiling lamp

vetro/glass Ø11 cm - H 38 cm

5 G9 x max 42W 230V

CE IP20 1m

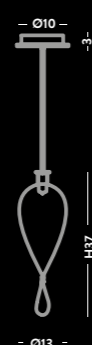

803.1L

Sospensione / Hanging lamp

vetro/glass Ø13 cm - cavo/cable 150 cm

1 G9 x max 42W 230V

CE IP20 1m

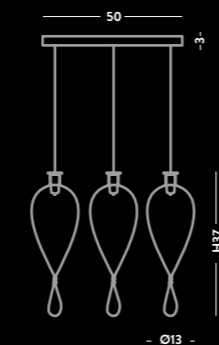

807.3L

Binario a soffitto / Ceiling track

vetro/glass Ø13 cm - cavo/cable 150 cm

3 G9 x max 42W 230V

CE IP20 1m

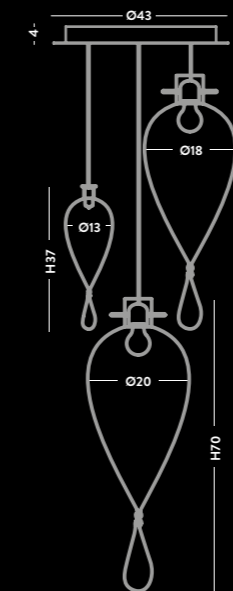

809MX.3L

Plafoniera / Ceiling lamp

vetro/glass Ø13/18/20 cm - cavo/cable 150 cm

1 G9 x max 42W 1 E14 x max 40W

1 E27 x max 70W 220-240V

CE IP20 1m



MED803.1L

Sospensione / Hanging lamp

vetro/glass Ø18 cm - cavo/cable 150 cm

1 E14 x max 40W 220-240V

CE IP20 1m



GIG803.1L

Sospensione / Hanging lamp

vetro/glass Ø20 cm - cavo/cable 150 cm

1 E27 x max 70W 220-240V

CE IP20 1m

807.3L - 809.5L - 809MX.3L
BINARIO E PLAFONIERA / CEILING TRACK AND CEILING LAMP:
ACCIAIO INOX RILUCIDATO / STAINLESS POLISHED STEEL

COLORI VETRO DISPONIBILI PER DIUSORE E PENDENTE / AVAILABLE GLASS COLOURS FOR DIUSER AND PENDANT



01 - Trasparente
Transparent

03 - Rosa
Pink

05 - Ambra
Amber

06 - Verde
Green

07 - Azzurro
Sky-blue

08 - Fumè
Fume

16 - Tabacco
Tobacco

17 - Rubino
Ruby

COLORI VETRO DISPONIBILI SOLO PER PENDENTE / AVAILABLE GLASS COLOURS ONLY FOR PENDANT



02 - Bianco
White

09 - Nero
Black

10 - Verde mela
Apple green

11 - Rosso
Red

12 - Arancio
Orange

13 - Viola
Violet

14 - Cobalto
Cobalt

ARTICOLI GIG NEL COLORE FUMÈ: SUPPLEMENTO DEL 10% SUL PREZZO DEL COLORATO / PRODUCTS GIG IN FUME COLOR: 10% SURCHARGE ON THE PRICE OF THE COLOURED



LUC

**LAMPADA DA SOSPENSIONE,
PLAFONIERA E BINARIO**

*HANGING LAMP, CEILING LAMP
AND CEILING TRACK*



GIG1503.1L

1503.1L

XXL1503.1L



XXL1503.1L

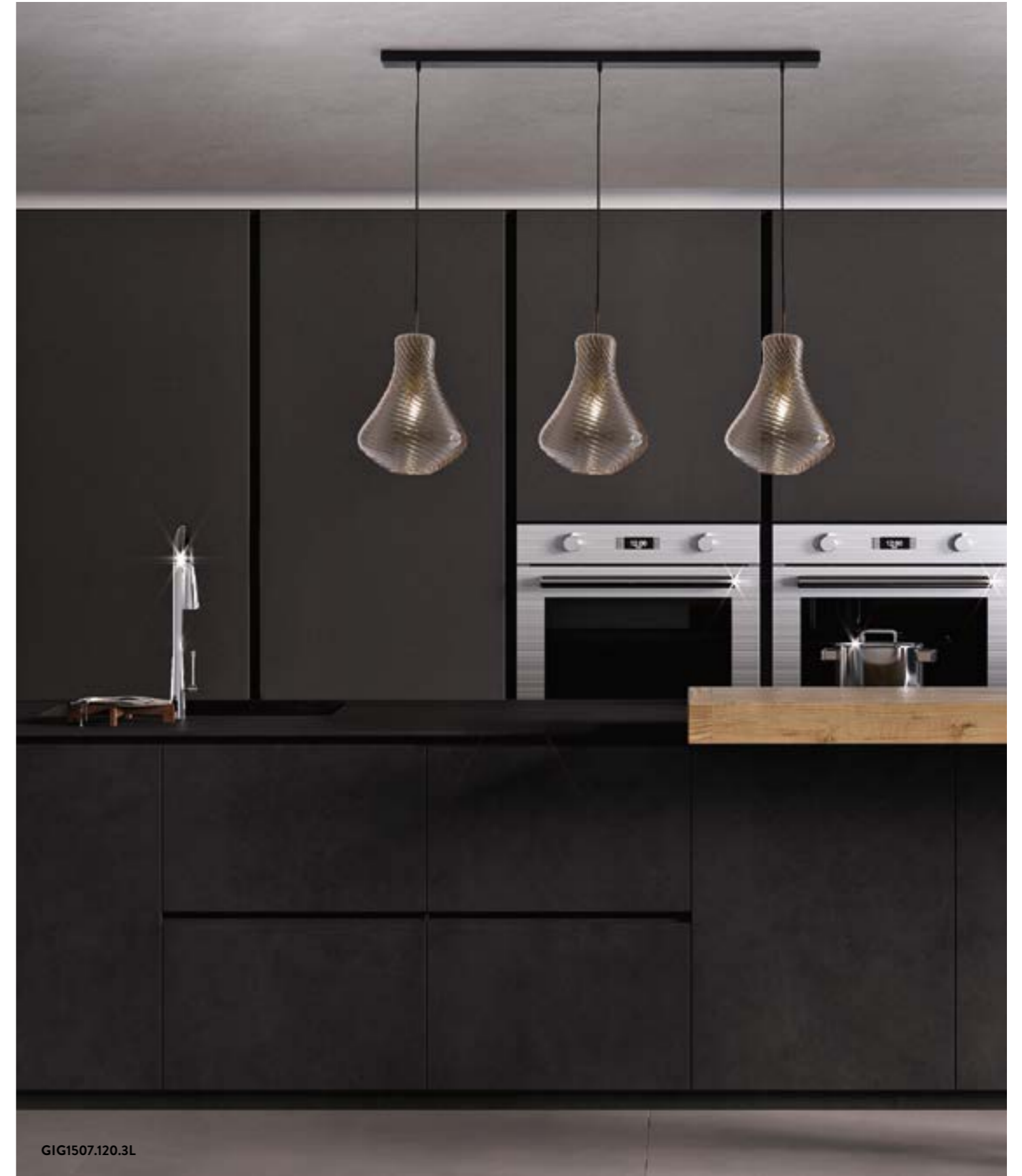

GIG1507.120.3L



XXL1503.1L

LUC

STRUTTURA METALLICA DISPONIBILE / AVAILABLE METAL STRUCTURE

- OTTONE SPAZZOLATO / BRUSHED BRASS
- ROSONE NERO / BLACK CANOPY
- CAVO NERO / BLACK CABLE

ULTERIORI COMPOSIZIONI A RICHIESTA
ADDITIONAL COMPOSITIONS ON DEMAND

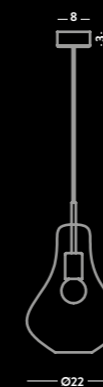

1503.1L

Sospensione / Hanging lamp

vetro/glass Ø22 cm - cavo/cable 150 cm

1 E27 x max 70W 220-240V

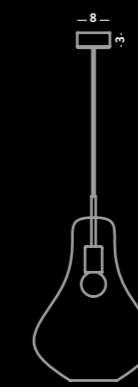

GIG1503.1L

Sospensione / Hanging lamp

vetro/glass Ø28 cm - cavo/cable 150 cm

1 E27 x max 70W 220-240V

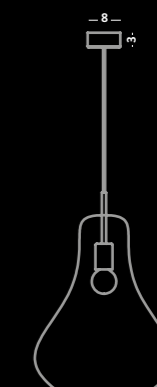

XXL1503.1L

Sospensione / Hanging lamp

vetro/glass Ø33 cm - cavo/cable 150 cm

1 E27 x max 70W 220-240V

COLORI VETRO DISPONIBILI / AVAILABLE GLASS COLOURS

01 - Trasparente
Transparent03 - Rosa
Pink05 - Ambra
Amber06 - Verde
Green07 - Azzurro
Sky-blue08 - Fumè
Fume16 - Tabacco
Tobacco17 - Rubino
Ruby

ARTICOLI GIG E XXL NEL COLORE FUMÈ: SUPPLEMENTO DEL 10% SUL PREZZO DEL COLORATO / PRODUCTS GIG AND XXL IN FUME COLOR: 10% SURCHARGE ON THE PRICE OF THE COLOURED



LANTERNA

**LAMPADA DA TAVOLO,
APPLIQUE E SOSPENSIONE**

*TABLE LAMP, WALL LAMP
AND HANGING LAMP*



AP1218.1L



R1217.1L



LU1219

LANTERNA

STRUTTURA METALLICA DISPONIBILE / AVAILABLE METAL STRUCTURE
- CROMO / CHROME

ULTERIORI COMPOSIZIONI A RICHIESTA
ADDITIONAL COMPOSITIONS ON DEMAND



1216.1L

Sospensione / Hanging lamp

vetro/glass Ø21 cm - cavo/cable 150 cm

1 E27 x max 70W 220-240V

CE IP20 1m



1217.1L

Sospensione / Hanging lamp

vetro/glass Ø26 cm - cavo/cable 150 cm

1 E27 x max 70W 220-240V

CE IP20 1m

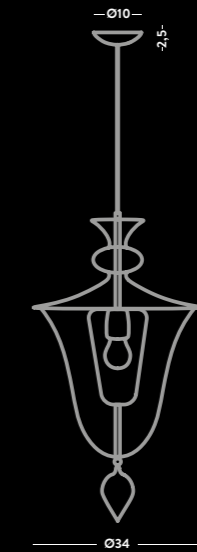

GIG1217.1L

Sospensione / Hanging lamp

vetro/glass Ø34 cm - cavo/cable 150 cm

1 E27 x max 70W 220-240V

CE IP20 1m

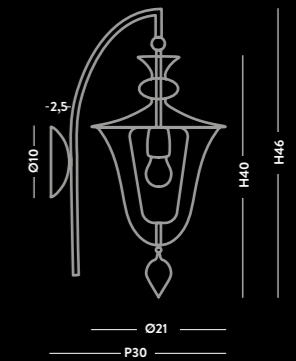

AP1218.1L

Applique/ Wall lamp

vetro/glass Ø21 cm - H46 cm

1 E27 x max 70W 220-240V

CE IP20 1m



LU1219.1L

Lampada da tavolo / Table lamp

vetro/glass Ø26 cm - H42 cm

1 E27 x max 60W 220-240V

CE IP20 1m

I cavi elettrici vengono forniti in tinta in caso di vetro nero, bianco, o rosso, mentre nelle altre colorazioni il cavo viene fornito in silicone trasparente. Specificare nell'ordine in caso di preferenza diversa da quella standard.

Electrical cables are provided to match the glass the black, white, or red coloured glass, while in the other colours the cable is supplied in transparent silicone. Specify in the order in the case of different preference from the standard.

Per VETRO RIGATO: aggiungere la lettera R davanti al codice al momento dell'ordine.

For RIBBED GLASS: add the letter R in front of the code when ordering.

CAVI IN TESSUTO DISPONIBILI / FABRIC CABLES AVAILABLE



COLORI VETRO DISPONIBILI / AVAILABLE GLASS COLOURS



01 - Trasparente
Transparent
03 - Rosa
Pink
05 - Ambra
Amber
06 - Verde
Green
07 - Azzurro
Sky-blue
08 - Fumè
Fume
16 - Tabacco
Tobacco
17 - Rubino
Ruby

COLORI PER VETRO TRASPARENTE CON PROFILO + PORTALAMPADA COLORATO / COLOURS FOR TRANSPARENT GLASS WITH EDGE + LAMP HOLDER COLOURED



02 - Bianco
White
09 - Nero
Black
10 - Verde mela
Apple green
11 - Rosso
Red
12 - Arancio
Orange
13 - Viola
Violet
14 - Cobalto
Cobalt

ARTICOLI GIG NEL COLORE FUMÈ: SUPPLEMENTO DEL 10% SUL PREZZO DEL COLORATO / PRODUCTS GIG IN FUME COLOR: 10% SURCHARGE ON THE PRICE OF THE COLOURED



ARABESQUE

**LAMPADA DA SOSPENSIONE
E PLAFONIERA**

*HANGING LAMP
AND CEILING LAMP*



RGIG1243.1L



ARABESQUE

STRUTTURA METALLICA DISPONIBILE / AVAILABLE METAL STRUCTURE
- CROMO / CHROME

ULTERIORI COMPOSIZIONI A RICHIESTA
ADDITIONAL COMPOSITIONS ON DEMAND

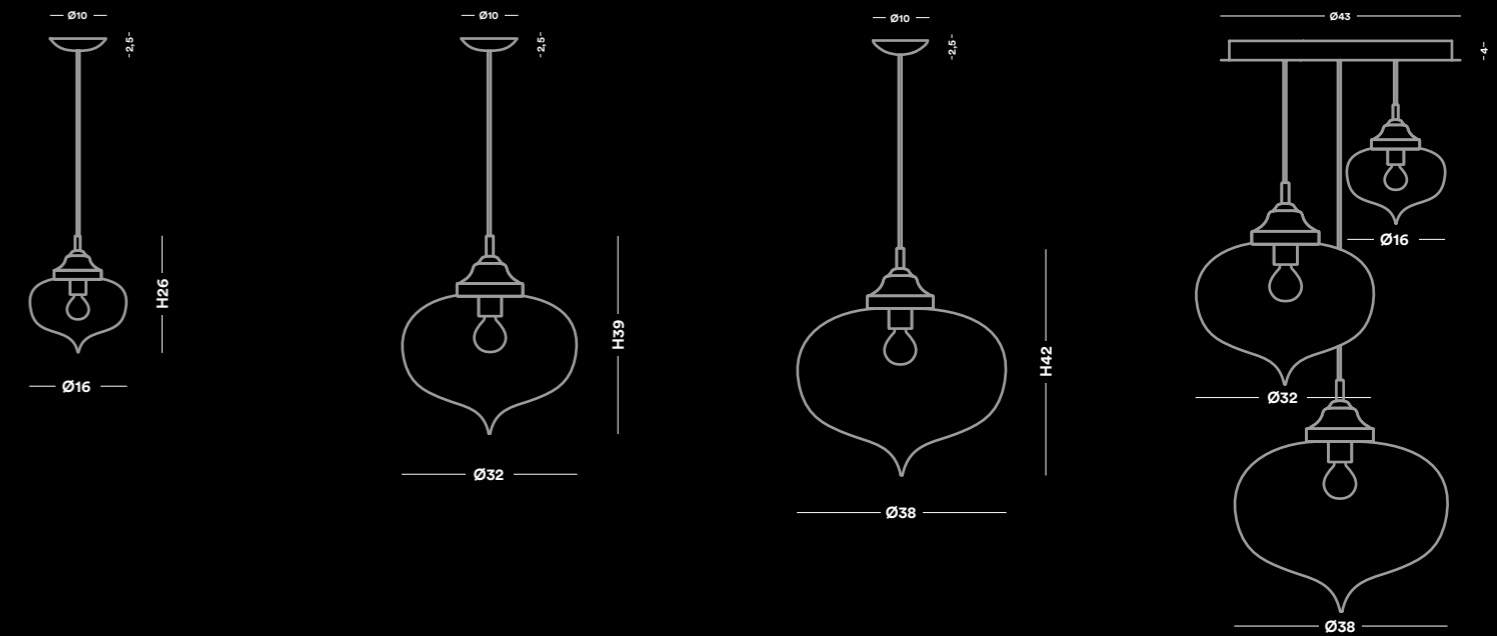

1243.1L

Sospensione / Hanging lamp
vetro/glass Ø16 cm - cavo/cable 150 cm
1 E14 x max 40W 220-240V
CE IP20 (1m)

GIG1243.1L

Sospensione / Hanging lamp
vetro/glass Ø32 cm - cavo/cable 150 cm
1 E27 x max 70W 220-240V
CE IP20 (1m)

XXL1243.1L

Sospensione / Hanging lamp
vetro/glass Ø38 cm - cavo/cable 150 cm
1 E27 x max 70W 220-240V
CE IP20 (1m)

1249MX.3L

Plafoniera / Ceiling lamp
vetro/glass Ø16/32/38 cm - cavo/cable 150 cm
1 E14 x max 40W
2 E27 x max 70W 220-240V
CE IP20 (1m)

Per **VETRO RIGATO**:
aggiungere la lettera R davanti
al codice al momento dell'ordine.

For **RIBBED GLASS**:
add the letter R in front
of the code when ordering.

1249MX.3L
PLAFONIERA / CEILING LAMP:
ACCIAIO INOX RILUCIDATO
STAINLESS POLISHED STEEL

COLORI VETRO DISPONIBILI / AVAILABLE GLASS COLOURS



01 - Trasparente
Transparent

03 - Rosa
Pink

05 - Ambra
Amber

06 - Verde
Green

07 - Azzurro
Sky-blue

08 - Fumè
Fume

16 - Tabacco
Tobacco

17 - Rubino
Ruby

ARTICOLI GIG E XXL NEL COLORE FUMÈ: SUPPLEMENTO DEL 10% SUL PREZZO DEL COLORATO / PRODUCTS GIG AND XXL IN FUME COLOR: 10% SURCHARGE ON THE PRICE OF THE COLOURED



LACRIMA

**LAMPADA DA TAVOLO, APPLIQUE
SOSPENSIONE, PLAFONIERA**

*TABLE LAMP, WALL LAMP,
HANGING LAMP, AND CEILING LAMP*



GIG1253.1L

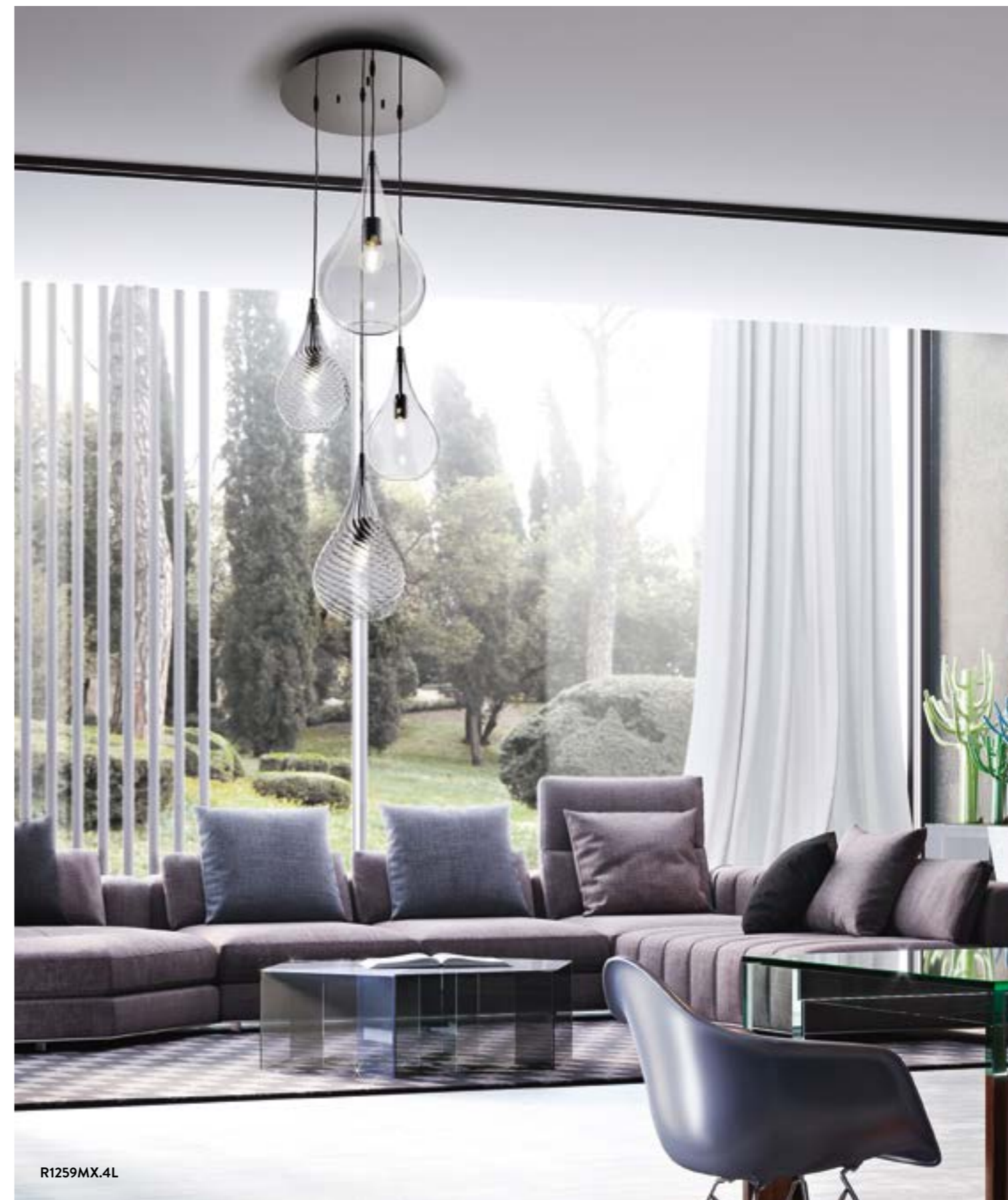

R1259MX.4L



R1259MX.4L

LACRIMA

STRUTTURA METALLICA DISPONIBILE / AVAILABLE METAL STRUCTURE
- CROMO / CHROME

(A RICHIESTA: SOSPENSIONE E14 PUÒ ESSERE REALIZZATO CON ATTACO E27)
(ON DEMAND: HANGING E14 CAN BE MADE WITH E27)

ULTERIORI COMPOSIZIONI A RICHIESTA
ADDITIONAL COMPOSITIONS ON DEMAND

Per **VETRO RIGATO**:
aggiungere la lettera R davanti
al codice al momento dell'ordine.

For **RIBBED GLASS**:
add the letter R in front
of the code when ordering.

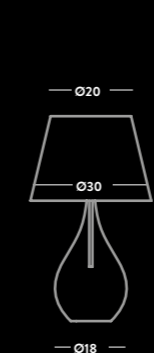

LU1250

Lampada da tavolo / Table lamp

vetro/glass Ø18 cm - H55 cm

1 E14 x max 40W 220-240V

CE IP20 1m

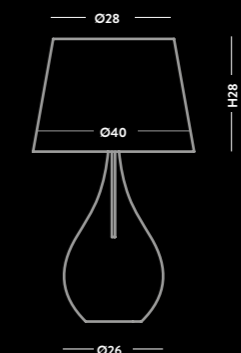

LUG1250

Lampada da tavolo / Table lamp

vetro/glass Ø26 cm - H70 cm

1 E27 x max 60W 220-240V

CE IP20 1m

Paralumi Pongè disponibili
per la linea Lacrime

Pongè lampshades available
for Lacrime



PO - Greca bassa
PO - Low trimming



PO - Greca alta
PO - High trimming

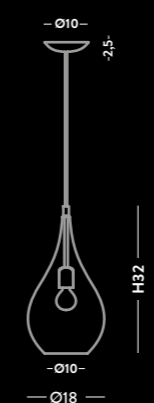

1253.1L

Sospensione / Hanging lamp

vetro/glass Ø18 cm - cavo/cable 150 cm

1 E14 x max 40W 220-240V

CE IP20 1m

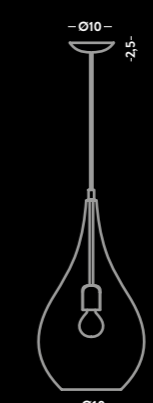

GIG1253.1L

Sospensione / Hanging lamp

vetro/glass Ø26 cm - cavo/cable 150 cm

1 E27 x max 70W 220-240V

CE IP20 1m

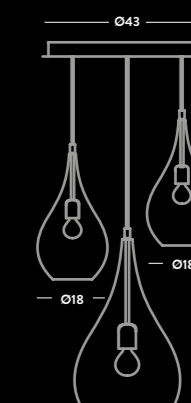

1259MX.3L

Plafoniera / Ceiling lamp

vetro/glass Ø18/26 cm - cavo/cable 150 cm

2 E14 x max 40W

1 E27 x max 70W 220-240V

CE IP20 1m

1259MX.3L
PLAFONIERA / CEILING LAMP:
ACCIAIO INOX RILUCIDATO
STAINLESS POLISHED STEEL

COLORI VETRO DISPONIBILI / AVAILABLE GLASS COLOURS



01 - Trasparente
Transparent

03 - Rosa
Pink

05 - Ambra
Amber

06 - Verde
Green

07 - Azzurro
Sky-blue

08 - Fumè
Fume

16 - Tabacco
Tobacco

17 - Rubino
Ruby

ARTICOLI GIG NEL COLORE FUMÈ: SUPPLEMENTO DEL 10% SUL PREZZO DEL COLORATO / PRODUCTS GIG IN FUME COLOR: 10% SURCHARGE ON THE PRICE OF THE COLOURED



LACRIMA MINI

**LAMPADA A SOSPENSIONE,
PLAFONIERA, APPLIQUE E BINARIO**

*HANGING LAMP, CEILING LAMP,
WALL LAMP AND CEILING TRACK*



RMINI1253.6L

LACRIMA MINI

STRUTTURA METALLICA DISPONIBILE / AVAILABLE METAL STRUCTURE
- CROMO / CHROME

(A RICHIESTA: SOSPENSIONE G9 PUÒ ESSERE REALIZZATA CON ATTACCO E14)
(ON DEMAND: HANGING G9 CAN BE MADE WITH E14)

ULTERIORI COMPOSIZIONI A RICHIESTA
ADDITIONAL COMPOSITIONS ON DEMAND



MINI1253.1L

Sospensione / Hanging lamp
vetro/glass Ø13 cm - cavo/cable 150 cm
1 G9 x max 42W 230V
CE IP20 (1m)

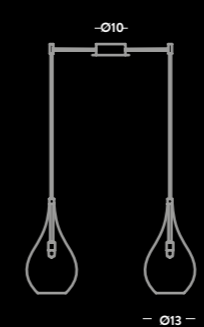

MINI1253.2L

Sospensione / Hanging lamp
vetro/glass Ø13 cm - cavo/cable 250 cm
2 G9 x max 42W 230V
CE IP20 (1m)

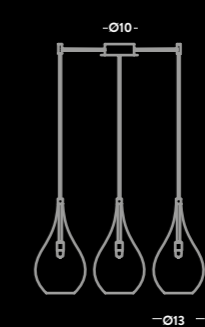

MINI1253.3L

Sospensione / Hanging lamp
vetro/glass Ø13 cm - cavo/cable 250 cm
3 G9 x max 42W 230V
CE IP20 (1m)

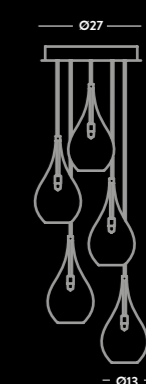

MINI1259.5L

Plafoniera / Ceiling lamp
vetro/glass Ø13 cm - cavo/cable 150 cm
5 G9 x max 42W 230V
CE IP20 (1m)

MINI1259.5L
PLAFONIERA / CEILING LAMP:
ACCIAIO INOX RILUCIDATO
STAINLESS POLISHED STEEL

Per VETRO RIGATO:
aggiungere la lettera R davanti
al codice al momento dell'ordine.

For RIBBED GLASS:
add the letter R in front
of the code when ordering.

COLORI VETRO DISPONIBILI / AVAILABLE GLASS COLOURS



01 - Trasparente
Transparent

03 - Rosa
Pink

05 - Ambra
Amber

06 - Verde
Green

07 - Azzurro
Sky-blue

08 - Fumè
Fume

16 - Tabacco
Tobacco

17 - Rubino
Ruby



300 G

**LAMPADA A SOSPENSIONE,
PLAFONIERA, APPLIQUE E BINARIO**

*HANGING LAMP, CEILING LAMP,
WALL LAMP AND CEILING TRACK*





GIG1347.3L

300G.

STRUTTURA METALLICA DISPONIBILE / AVAILABLE METAL STRUCTURE:
CROMO/CHROME

ULTERIORI COMPOSIZIONI A RICHIESTA
ADDITIONAL COMPOSITIONS ON DEMAND

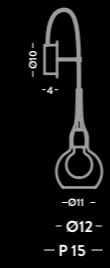

AP1341.1L

Applique / Wall lamp

vetro/glass Ø12 cm - cavo/cable 50 cm

1 E27 x max 70W 220-240V

CE IP20 1m



1343.1L

Sospensione / Hanging lamp

vetro/glass Ø14 cm - cavo/cable 150 cm

1 E27 x max 70W 220-240V

CE IP20 1m

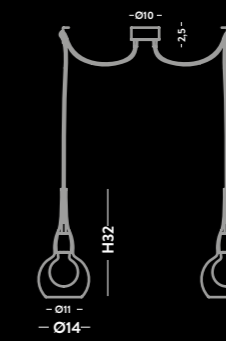

1343.2L

Sospensione / Hanging lamp

vetro/glass Ø14 cm - cavo/cable 250 cm

2 E27 x max 70W 220-240V

CE IP20 1m

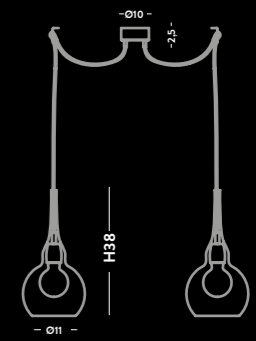

GIG1343.2L

Sospensione / Hanging lamp

vetro/glass Ø18 cm - cavo/cable 250 cm

2 E27 x max 70W 220-240V

CE IP20 1m

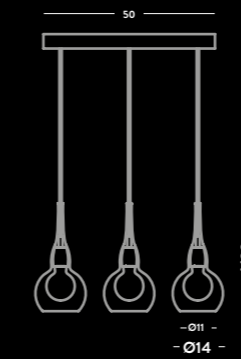

1347.3L

Binario a soffitto / Ceiling track

vetro/glass Ø14 cm - cavo/cable 150 cm

3 E27 x max 70W 220-240V

CE IP20 1m



GIG1343.1L

Sospensione / Hanging lamp

vetro/glass Ø18 cm - cavo/cable 150 cm

1 E27 x max 70W 220-240V

CE IP20 1m

1347.3L
BINARIO / CEILING TRACK:
ACCIAIO INOX RILUCIDATO
STAINLESS POLISHED STEEL

COLORI VETRO DISPONIBILI / AVAILABLE GLASS COLOURS

01 - Trasparente
Transparent03 - Rosa
Pink05 - Ambra
Amber06 - Verde
Green07 - Azzurro
Sky-blue08 - Fumè
Fume16 - Tabacco
Tobacco17 - Rubino
Ruby

COLORI PER VETRO TRASPARENTE CON PROFILO + PORTALAMPADA COLORATO / COLOURS FOR TRANSPARENT GLASS WITH EDGE + LAMP HOLDER COLOURED

02 - Bianco
White09 - Nero
Black10 - Verde mela
Apple green11 - Rosso
Red12 - Arancio
Orange13 - Viola
Violet14 - Cobalto
Cobalt

ARTICOLI GIG NEL COLORE FUMÈ: SUPPLEMENTO DEL 10% SUL PREZZO DEL COLORATO / PRODUCTS GIG IN FUME COLOR: 10% SURCHARGE ON THE PRICE OF THE COLOURED



CLASSIC COLLECTION

ANASTASIA



1154.3L

LAMPADARI E APPLIQUE
CHANDELIER, WALL LAMP



AP1151.2L



1154.8L



1154.8L



1154.12+6/18L



1154.8L

ANASTASIA

STRUTTURA METALLICA DISPONIBILE / AVAILABLE METAL STRUCTURE:
CROMO, ORO / CHROME, GOLD

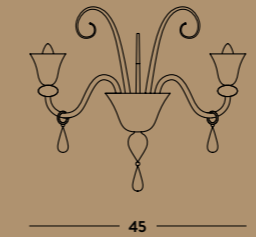

AP1151.2L

Applique / Wall lamp

L45 cm - P25 cm - H50 cm

2 E14 x max 40W 220-240V

CE IP20 1m

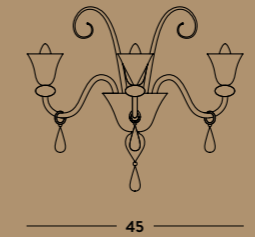

AP1151.3L

Applique / Wall lamp

L45 cm - P30 cm - H50 cm

3 E14 x max 40W 220-240V

CE IP20 1m

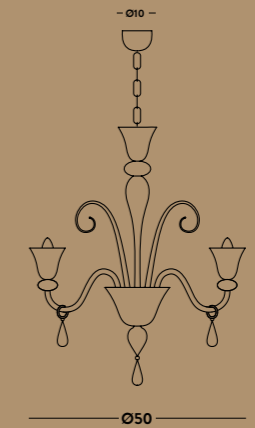

1154.3L

Lampadario / Chandelier

Ø50 cm - H65 cm - catena/chain 50 cm

3 E14 x max 40W 220-240V

CE IP20 1m

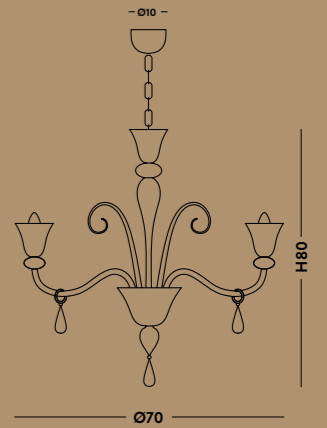

1154.6L

Lampadario / Chandelier

Ø70 cm - H80 cm - catena/chain 50 cm

6 E14 x max 40W 220-240V

CE IP20 1m

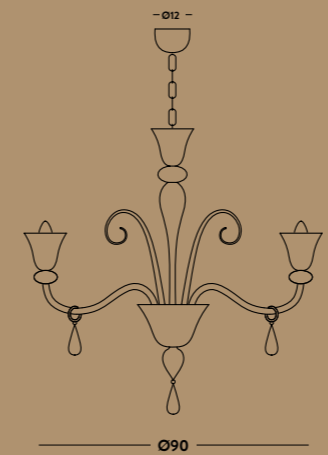

1154.8L

Lampadario / Chandelier

Ø90 cm - H90 cm - catena/chain 50 cm

8 E14 x max 40W 220-240V

CE IP20 1m

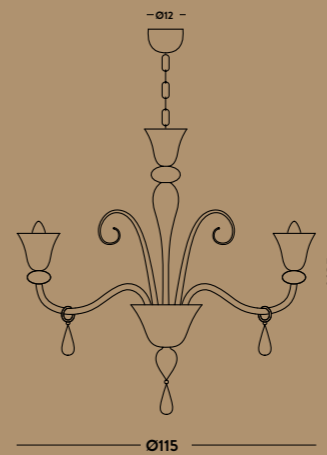

1154.12L

Lampadario / Chandelier

Ø115 cm - H95 cm - catena/chain 50 cm

12 E14 x max 40W 220-240V

CE IP20 1m

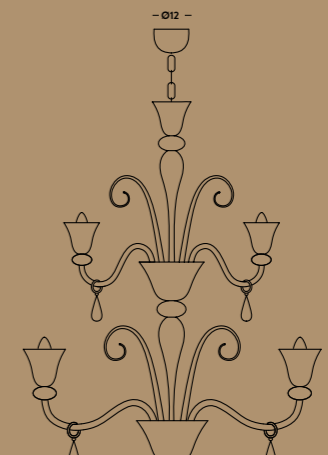

1154.12+6/18L

Lampadario / Chandelier

Ø115 cm - H175 cm - catena/chain 50 cm

18 E14 x max 40W 220-240V

CE IP20 1m

COLORI VETRO DISPONIBILI / AVAILABLE GLASS COLOURS





1274.6+4/10L

IMPERIAL

LAMPADARI E APPLIQUE

CHANDELIER, WALL LAMP



1274.6+4/10L



1274.8+8/16L

IMPERIAL

STRUTTURA METALLICA DISPONIBILE / AVAILABLE METAL STRUCTURE:
CROMO, ORO / CHROME, GOLD

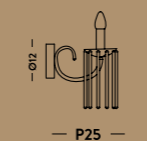

AP1271.1L

Applique / Wall lamp

L15 cm - P25 cm - H30 cm

1 E14 x max 40W 220-240V

CE IP20 (1m)

CON SWAROVSKI / WITH SWAROVSKI
TUBINO SOFFIATO FORNITO
SEMPRE TRASPARENTE /
BLOWN PIPE ALWAYS TRANSPARENT

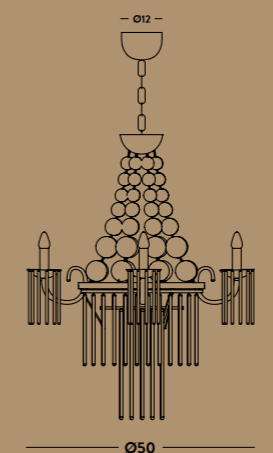

1274.3+4/7L

Lampadario / Chandelier

Ø50 cm - H90 cm - catena/chain 50 cm

3 E14 x max 40W 4 G9 x max 42W 230V

CE IP20 (1m)

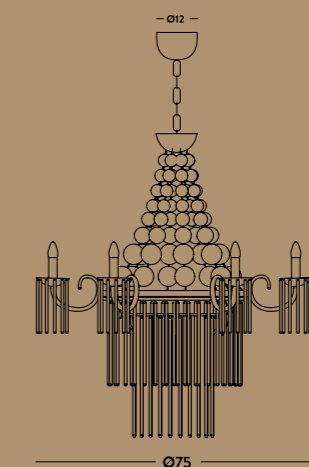

1274.6+4/10L

Lampadario / Chandelier

Ø75 cm - H100 cm - catena/chain 50 cm

6 E14 x max 40W 4 G9 x max 42W 230V

CE IP20 (1m)

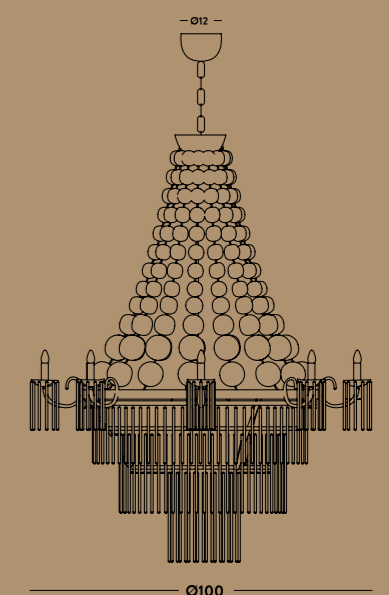

1274.8+8/16L

Lampadario / Chandelier

Ø100 cm - H145 cm - catena/chain 50 cm

8 E14 x max 40W 8 G9 x max 42W 230V

CE IP20 (1m)

COLORI VETRO DISPONIBILI / AVAILABLE GLASS COLOURS



1044.8+4/12L



LOLITA

LAMPADARI E APPLIQUE

CHANDELIER, WALL LAMP



LOLITA

STRUTTURA METALLICA DISPONIBILE
 AVAILABLE METAL STRUCTURE:
 CROMO, ORO / CHROME, GOLD

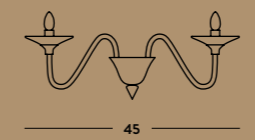

AP1041.2L
 Applique / Wall lamp
 L45 cm - P35 cm - H25 cm
 2 E14 x max 40W 220-240V
 CE IP20 1m

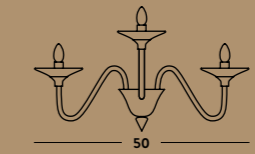

AP1041.3L
 Applique / Wall lamp
 L50 cm - P35 cm - H35 cm
 3 E14 x max 40W 220-240V
 CE IP20 1m

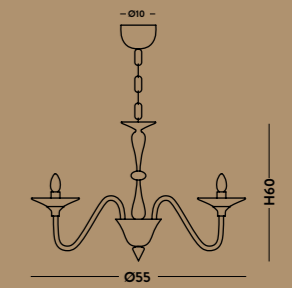

1044.3L
 Lampadario / Chandelier
 Ø55 cm - H60 cm - catena/chain 50 cm
 3 E14 x max 40W 220-240V
 CE IP20 1m

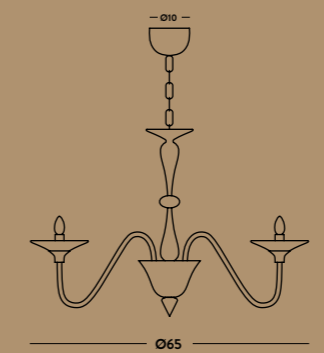

1044.6L
 Lampadario / Chandelier
 Ø65 cm - H65 cm - catena/chain 50 cm
 6 E14 x max 40W 220-240V
 CE IP20 1m

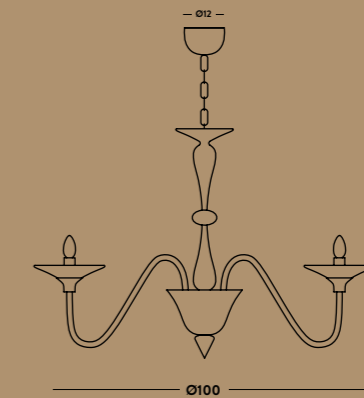

1044.8L
 Lampadario / Chandelier
 Ø100 cm - H75 cm - catena/chain 50 cm
 8 E14 x max 40W 220-240V
 CE IP20 1m

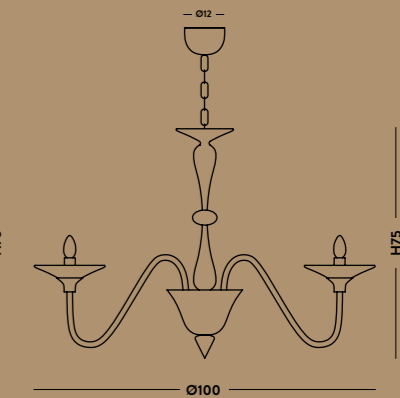

1044.12L
 Lampadario / Chandelier
 Ø100 cm - H75 cm - catena/chain 50 cm
 12 E14 x max 40W 220-240V
 CE IP20 1m

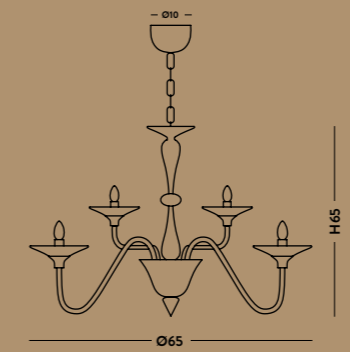

1044.6+3/9L
 Lampadario / Chandelier
 Ø65 cm - H65 cm - catena/chain 50 cm
 9 E14 x max 40W 220-240V
 CE IP20 1m

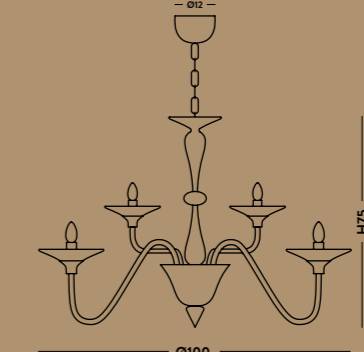

1044.8+4/12L
 Lampadario / Chandelier
 Ø100 cm - H75 cm - catena/chain 50 cm
 12 E14 x max 40W 220-240V
 CE IP20 1m

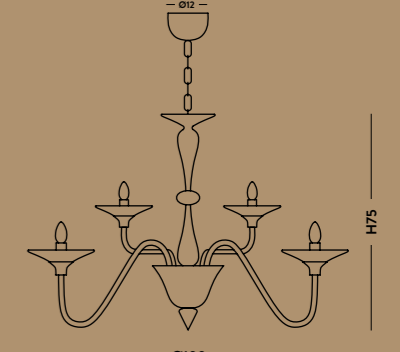

1044.12+6/18L
 Lampadario / Chandelier
 Ø100 cm - H75 cm - catena/chain 50 cm
 18 E14 x max 40W 220-240V
 CE IP20 1m

COLORI VETRO DISPONIBILI / AVAILABLE GLASS COLOURS

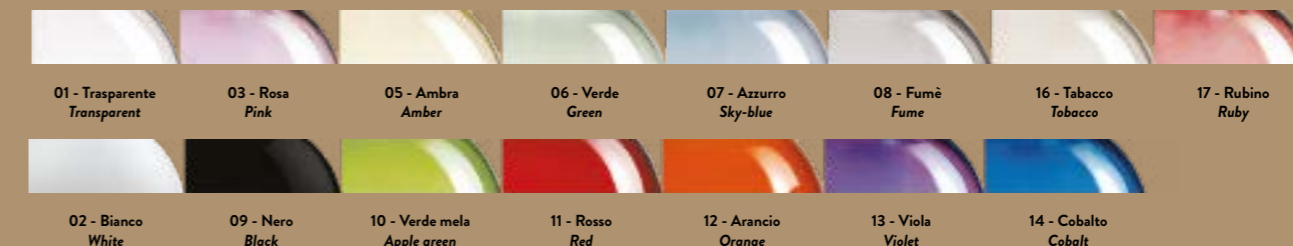



AP851.1L

854.6L

GLOBO

LAMPADARI E APPLIQUE
CHANDELIER, WALL LAMP



856.7L



AP851.3L

GLOBO

STRUTTURA METALLICA DISPONIBILE / AVAILABLE METAL STRUCTURE:

CROMO (A RICHIESTA: FOGLIA ORO/ARGENTO),
ORO / CHROME (ON DEMAND: GOLD/SILVER LEAF)

Per **VETRO RIGATO**:
aggiungere la lettera R davanti
al codice al momento dell'ordine.

For **RIBBED GLASS**:
add the letter R in front
of the code when ordering.

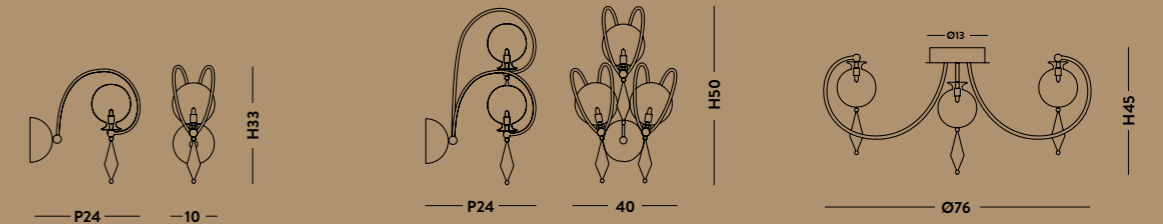

AP851.1L

Applique / Wall lamp
L 10 cm - P 24 cm - H 33 cm

1 G9 x max 42W 230V

CE IP20 1m

AP851.3L

Applique / Wall lamp
L 40 cm - P 24 cm - H 50 cm

3 G9 x max 42W 230V

CE IP20 1m

856.7L

Plafoniera / Ceiling lamp
Ø76 cm - H 45 cm

7 G9 x max 42W 230V

CE IP20 1m

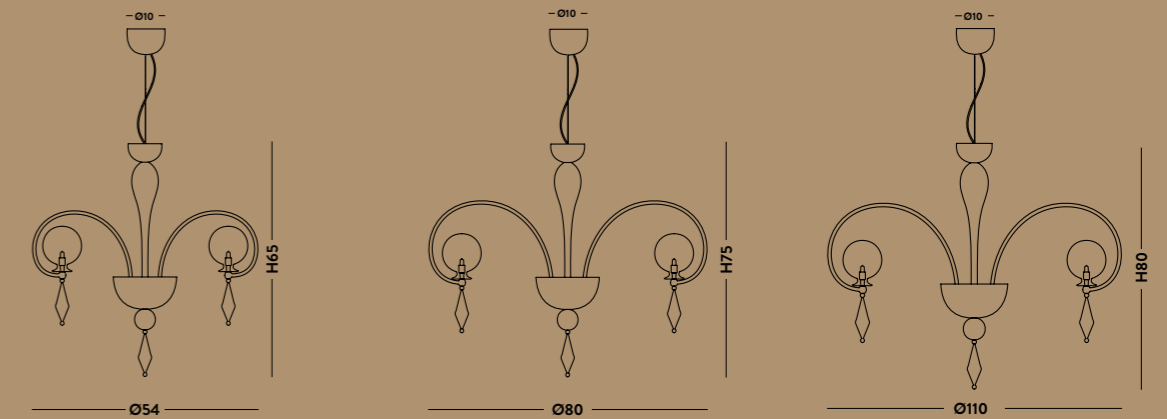

854.3L

Lampadario / Chandelier
Ø54 cm - H 65 cm - cavo/cable 150 cm

3 G9 x max 42W 230V

CE IP20 1m

854.6L

Lampadario / Chandelier
Ø80 cm - H 75 cm - cavo/cable 150 cm

6 G9 x max 42W 230V

CE IP20 1m

854.8L

Lampadario / Chandelier
Ø110 cm - H 80 cm - cavo/cable 150 cm

8 G9 x max 42W 230V

CE IP20 1m

COLORI VETRO DISPONIBILI / AVAILABLE GLASS COLOURS



COLORI VETRO DISPONIBILI PER DIFFUSORI / AVAILABLE GLASS COLOURS FOR DIFFUSERS

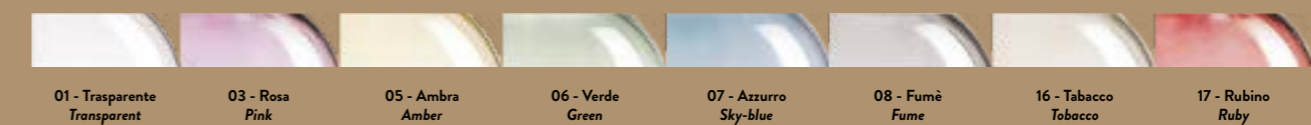



MAXIMILIAN

LAMPADARI E APPLIQUE

CHANDELIER, WALL LAMP



AP681.3L



684.12L

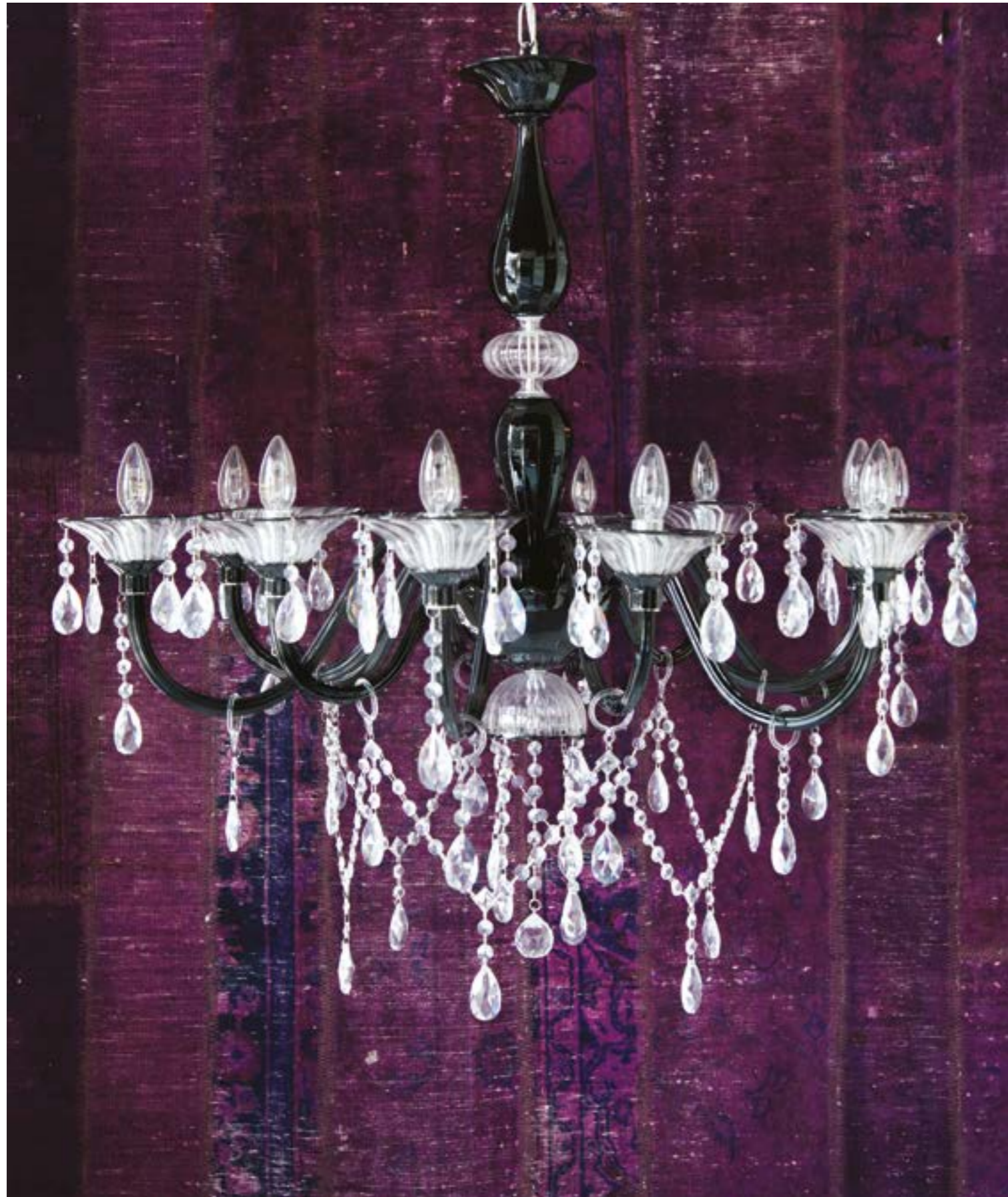

684.12L

MAXIMILIAN

STRUTTURA METALLICA DISPONIBILE / AVAILABLE METAL STRUCTURE:
CROMO, ORO / CHROME, GOLD

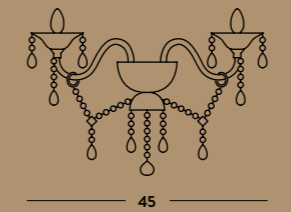

AP681.2L

Applique / Wall lamp

L45 cm - P25 cm - H35 cm

2 E14 x max 40W 220-240V

CE IP20 (1m)

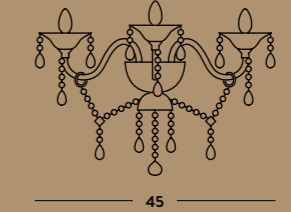

AP681.3L

Applique / Wall lamp

L45 cm - P30 cm - H35 cm

3 E14 x max 40W 220-240V

CE IP20 (1m)

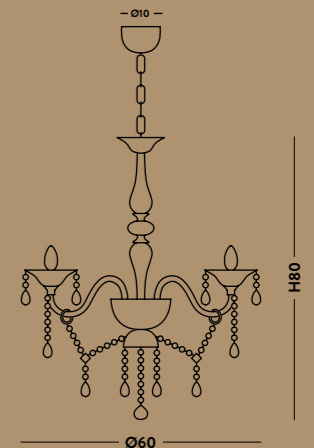

684.3L

Lampadario / Chandelier

Ø60 cm - H80 cm - catena/chain 50 cm

3 E14 x max 40W 220-240V

CE IP20 (1m)

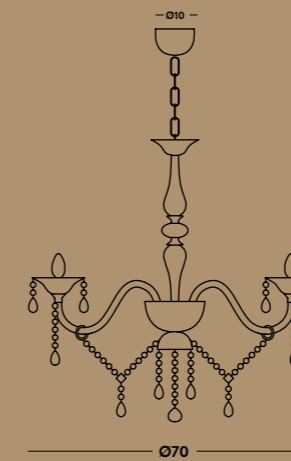

684.6L

Lampadario / Chandelier

Ø70 cm - H90 cm - catena/chain 50 cm

6 E14 x max 40W 220-240V

CE IP20 (1m)

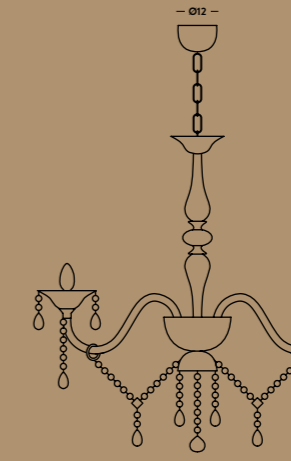

684.8L

Lampadario / Chandelier

Ø90cm - H100 cm - catena/chain 50 cm

8 E14 x max 40W 220-240V

CE IP20 (1m)

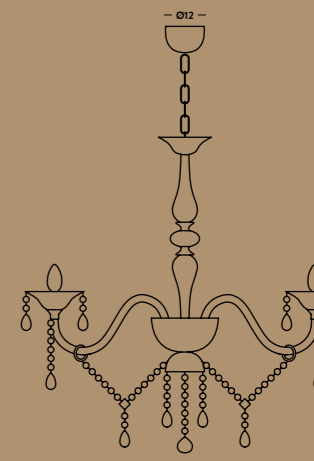

684.12L

Lampadario / Chandelier

Ø95cm - H110 cm - catena/chain 50 cm

12 E14 x max 40W 220-240V

CE IP20 (1m)

COLORI VETRO DISPONIBILI / AVAILABLE GLASS COLOURS





TWIST

LAMPADARI E APPLIQUE
CHANDELIER, WALL LAMP



AP1161.2L

TWIST

STRUTTURA METALLICA DISPONIBILE / AVAILABLE METAL STRUCTURE:
CROMO/CHROME - ORO/GOLD

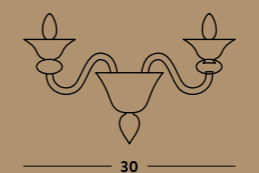

AP1161.2L

Applique / Wall lamp

L30 cm - P25 cm - H35 cm

2 E14 x max 40W 220-240V

CE IP20 1m

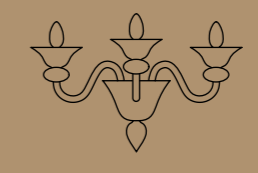

AP1161.3L

Applique / Wall lamp

L30 cm - P28 cm - H35 cm

3 E14 x max 40W 220-240V

CE IP20 1m

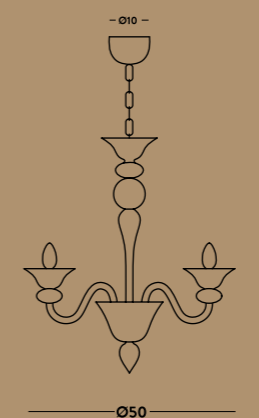

1164.3L

Lampadario / Chandelier

Ø50 cm - H65 cm - catena/chain 50 cm

3 E14 x max 40W 220-240V

CE IP20 1m

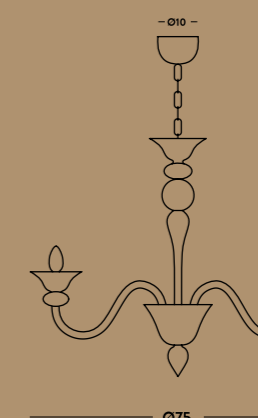

1164.6L

Lampadario / Chandelier

Ø75 cm - H75 cm - catena/chain 50 cm

6 E14 x max 40W 220-240V

CE IP20 1m

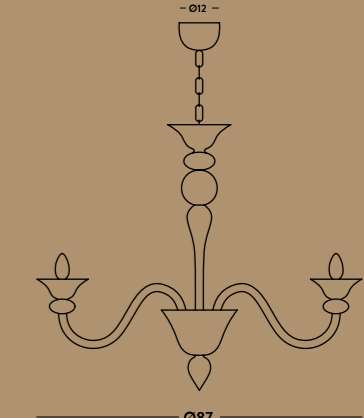

1164.8L

Lampadario / Chandelier

Ø87 cm - H80 cm - catena/chain 50 cm

8 E14 x max 40W 220-240V

CE IP20 1m

COLORI VETRO DISPONIBILI / AVAILABLE GLASS COLOURS





SOFFIO

LAMPADARI E APPLIQUE

CHANDELIER, WALL LAMP



44.6L

SOFFIO

STRUTTURA METALLICA DISPONIBILE / AVAILABLE METAL STRUCTURE:
CROMO/CHROME - ORO/GOLD

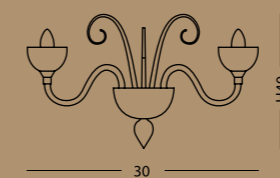

AP41.2L

Applique / Wall lamp

L30 cm - P25 cm - H40 cm

2 E14 x max 40W 220-240V

CE IP20 (1m)

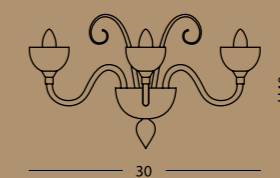

AP41.3L

Applique / Wall lamp

L30 cm - P30 cm - H40 cm

3 E14 x max 40W 220-240V

CE IP20 (1m)

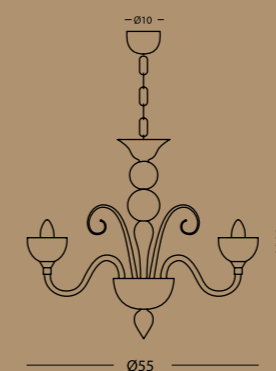

44.3L

Lampadario / Chandelier

Ø55 cm - H60 cm - catena/chain 50 cm

3 E14 x max 40W 220-240V

CE IP20 (1m)

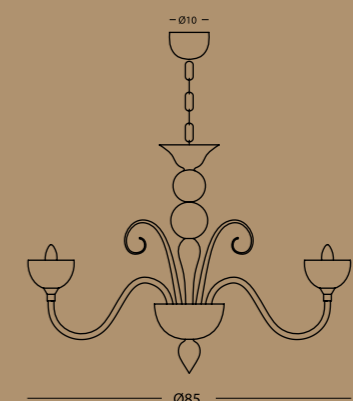

44.6L

Lampadario / Chandelier

Ø85 cm - H80 cm - catena/chain 50 cm

6 E14 x max 40W 220-240V

CE IP20 (1m)

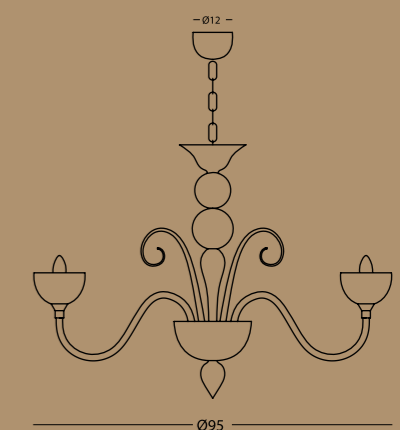

44.8L

Lampadario / Chandelier

Ø95 cm - H85 cm - catena/chain 50 cm

8 E14 x max 40W 220-240V

CE IP20 (1m)

COLORI VETRO DISPONIBILI / AVAILABLE GLASS COLOURS





54.6L

COLOR

LAMPADARI E APPLIQUE
CHANDELIER, WALL LAMP

COLOR

STRUTTURA METALLICA DISPONIBILE / AVAILABLE METAL STRUCTURE:
CROMO/CHROME - ORO/GOLD



54.8L



AP51.2L
Applique / Wall lamp
L30 cm - P20 cm - H35 cm
2 E14 x max 40W 220-240V
CE IP20 1m

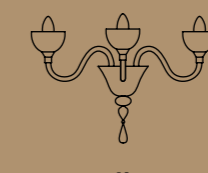

AP51.3L
Applique / Wall lamp
L30 cm - P30 cm - H35 cm
3 E14 x max 40W 220-240V
CE IP20 1m

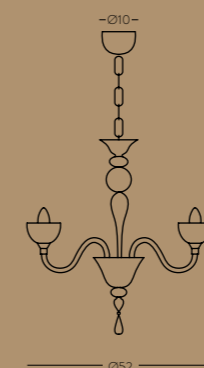

54.3L
Lampadario / Chandelier
Ø52 cm - H60 cm - catena/chain 50 cm
3 E14 x max 40W 220-240V
CE IP20 1m

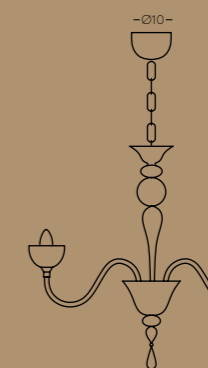

54.6L
Lampadario / Chandelier
Ø75 cm - H80 cm - catena/chain 50 cm
6 E14 x max 40W 220-240V
CE IP20 1m

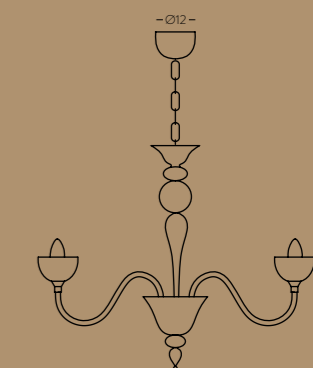

54.8L
Lampadario / Chandelier
Ø85 cm - H85 cm - catena/chain 50 cm
8 E14 x max 40W 220-240V
CE IP20 1m

COLORI VETRO DISPONIBILI / AVAILABLE GLASS COLOURS





LAMPADE/ PIANTANE

**LAMPADE E PIANTANE
DA TAVOLO E TERRA**

TABLE AND FLOOR LAMPS

ORGANZA



PONGÈ



PONGÈ

STRUTTURA METALLICA DISPONIBILE / AVAILABLE METAL STRUCTURE:
CROMO, ORO / CHROME, GOLD

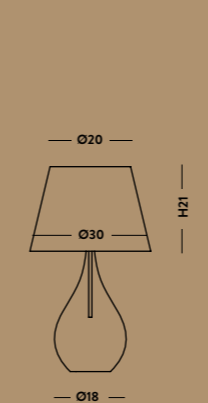
**LU1250**

Lampada da tavolo / Table lamp

vetro/glass Ø18 cm - H55 cm

1 E14 x max 40W 220-240V

CE IP20 □ 1m

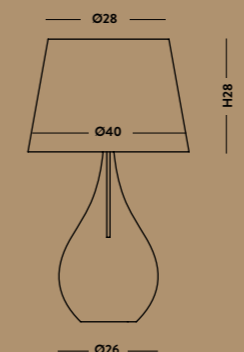
**LUGIG1250**

Lampada da tavolo / Table lamp

vetro/glass Ø26 cm - H70 cm

1 E27 x max 60W 220-240V

CE IP20 □ 1m

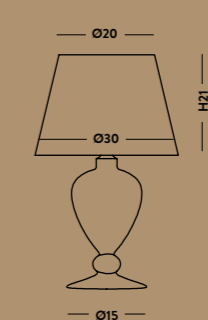
**LU1011**

Lampada da tavolo / Table lamp

Ø30 cm - H50 cm

1 E14 x max 40W 220-240V

CE IP20 □ 1m

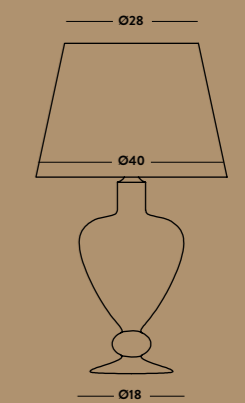
**LU1012**

Lampada da tavolo / Table lamp

Ø40 cm - H70 cm

1 E27 x max 60W 220-240V

CE IP20 □ 1m

PARALUMI PONGÈ DISPONIBILI / PONGÈ LAMP SHADES AVAILABLE



PO - Greca bassa
PO - Low trimming



PO - Greca alta
PO - High trimming

COLORI VETRO DISPONIBILI / AVAILABLE GLASS COLOURS



PIANTANE/FLOOR

STRUTTURA METALLICA DISPONIBILE / AVAILABLE METAL STRUCTURE:
CROMO, ORO / CHROME, GOLD

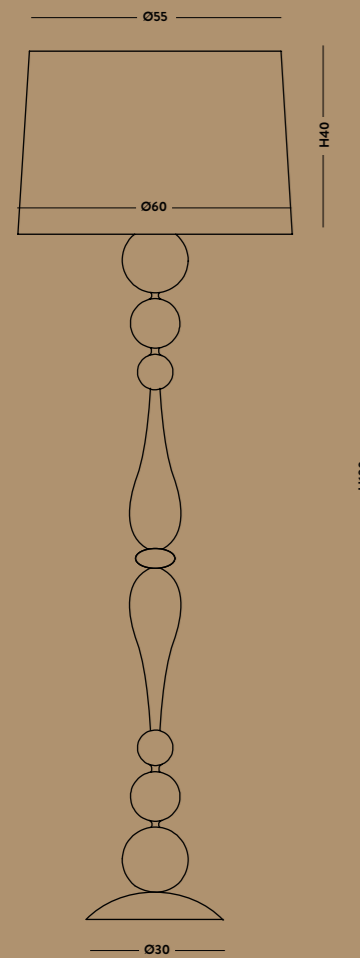

653.3L

Piantana / Floor lamp

(paralume/lampshade in ORGANZA)

Ø60 cm - H190 cm

3 E27 x max 70W 220-240V

CE IP20 1m

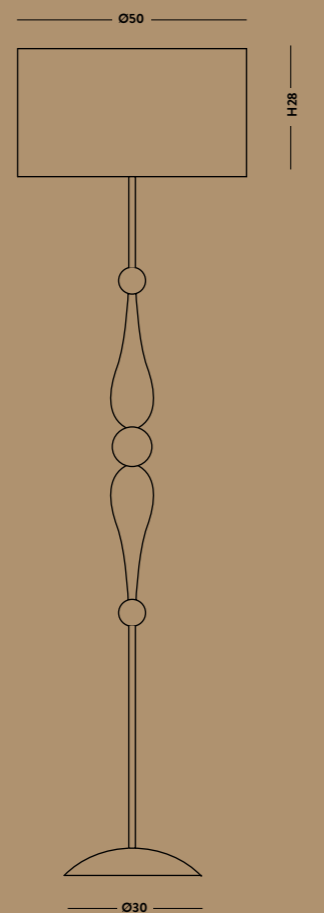

LU1095.1L

Piantana / Floor lamp

(paralume/lampshade in CREPONNE)

Ø50 cm - H180 cm

1 E27 x max 70W 220-240V

CE IP20 1m

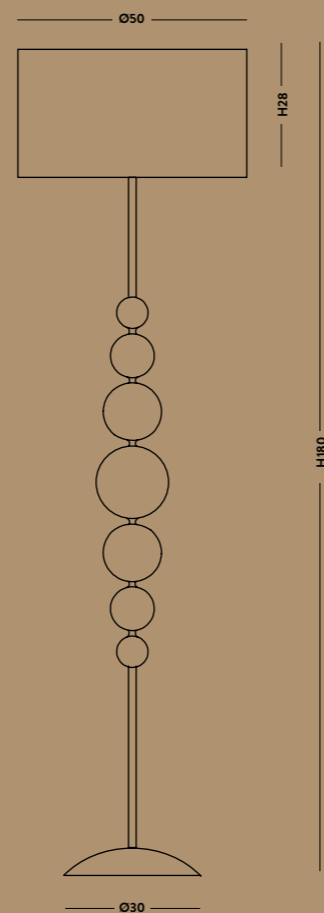

LU1096.1L

Piantana / Floor lamp

(paralume/lampshade in CREPONNE)

Ø50 cm - H180 cm

1 E27 x max 70W 220-240V

CE IP20 1m

PARALUMI CREPONNE DISPONIBILI / CREPONNE LAMP SHADES AVAILABLE



CR - Beige
CR - Beige



CR - Nero
CR - Black

PARALUMI ORGANZA DISPONIBILI / ORGANZA LAMP SHADES AVAILABLE



OR - Bianco
OR - White



OR - Nero
OR - Black



OR - Grigio
OR - Gray



OR - Ambra
OR - Amber

ORGANZA

STRUTTURA METALLICA DISPONIBILE / AVAILABLE METAL STRUCTURE:
CROMO, ORO / CHROME, GOLD

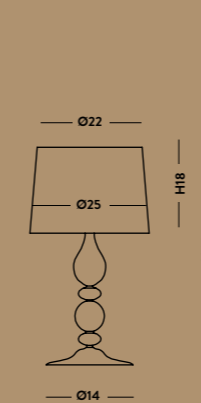

LU1078

Lampada da tavolo / Table lamp

Ø25 cm - H46 cm

1 E14 x max 40W 220-240V

CE IP20 1m

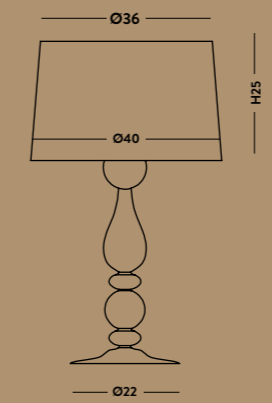

LU1077

Lampada da tavolo / Table lamp

Ø40 cm - H72 cm

1 E27 x max 60W 220-240V

CE IP20 1m

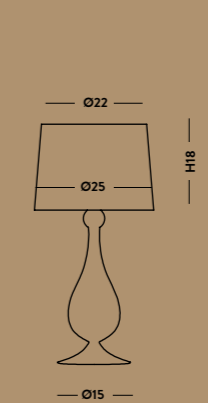

LU1082

Lampada da tavolo / Table lamp

Ø25 cm - H46 cm

1 E14 x max 40W 220-240V

CE IP20 1m

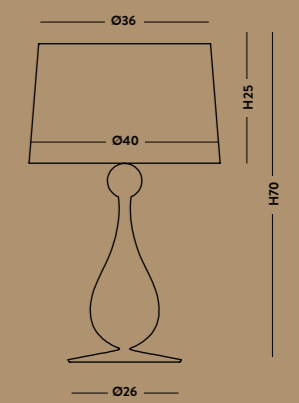

LU1081

Lampada da tavolo / Table lamp

Ø40 cm - H70 cm

1 E27 x max 60W 220-240V

CE IP20 1m

COLORI VETRO DISPONIBILI / AVAILABLE GLASS COLOURS



COLORI VETRO DISPONIBILI / AVAILABLE GLASS COLOURS



REFERENCES





ZOE®



ZOE®



LADY LOUIS®



FLUTE



INTI





SCARLETT



AUF



ZOE®



FINITURE

COLORI DISPONIBILI PER TUTTI I PRODOTTI DOVE C'È FONTE DI CALORE E DOVE L'ELEMENTO ILLUMINANTE NON HA ARIA A SUFFICIENZA PER IL RAFFREDDAMENTO.

COLOURS AVAILABLE FOR ALL PRODUCTS WHERE THERE IS A SOURCE OF HEAT, AND WHERE THE LIGHTING ELEMENT HAS NOT ENOUGH AIR FOR COOLING.



COLORI NON DISPONIBILI PER ELEMENTI ILLUMINANTI CHIUSI DOVE IL CALORE DELLA FONTE LUMINOSA NON HA ARIA A SUFFICIENZA PER IL RAFFREDDAMENTO.

SI CONSIGLIA DI NON USARLI NEI DIFFUSORI CHIUSI COME PER ESEMPIO NELL'ARTICOLO GOCCIA. PER OGNI LINEA È STATA INSERITA LA TABELLA CROMATICA PER I DIFFUSORI, VI PREGHIAMO DI RISPETTARLA.

COLOURS NOT AVAILABLE FOR CLOSED LIGHTING ELEMENTS WHERE THE HEAT OF THE LIGHT SOURCE DOES NOT HAVE ENOUGH AIR FOR COOLING.

IT IS ADVISABLE NOT TO USE THEM IN CLOSED DIFFUSERS SUCH AS ITEM GOCCIA. FOR EACH SERIES IT HAS BEEN INSERTED THE COLOR CHART FOR DIFFUSERS, PLEASE RESPECT IT.

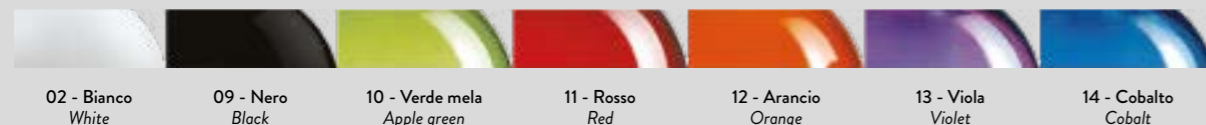

IL COLORE VIOLA CON L'ACCENSIONE DELLA LAMPADINA SI OPACIZZA. NON È UN DIFETTO MA UNA REAZIONE DELLA LUCE SUL COLORE STESSO.

VIOLET COLOUR BECOMES OPAQUE WITH THE LIGHTING OF THE BULB. IT IS NOT A DEFECT BUT A REACTION TO THE COLOR OF THE LIGHT ITSELF.



I PRODOTTI CON PORTALAMPADA E14 E27 E G9 NON INCLUDONO LE LAMPADINE. PRODUCTS WITH E14 E27 AND G9 LAMP HOLDERS DO NOT INCLUDE BULBS.

ARTICOLI GIG E XXL NEL COLORE FUMÈ: SUPPLEMENTO DEL 10% SUL PREZZO DEL COLORATO. PRODUCTS GIG AND XXL IN FUME COLOUR: 10% SURCHARGE ON THE PRICE OF THE COLOURED.



**COLORI METALLICI VETRO DISPONIBILI
METALLIC GLASS COLOURS AVAILABLE**

MODELLO / MODEL COLORI / COLOURS

MODELLO / MODEL	COLORI / COLOURS					
AUF	Oro rosa Rose gold					
DOLIUM	Oro rosa Rose gold	Titanio Titanium				
ECLISSE	Nero Black	Oro rosa Rose gold	Oro Gold	Bronzo Bronze	Arcobaleno Rainbow	
FIJI®	Nero opaco Matt black	Acciaio Steel	Oro rosa Rose gold	Miele Honey		
FLUTE	Nero Black	Oro rosa Rose gold	Acqua marina Sea water	Arcobaleno Rainbow		
INTI	Bianco satinato Satin white					
LADY LOUIS®	Aubergine Aubergine	Oro Gold	Bronzo Bronze			
TAO	Oro rosa Rose gold	Titanio Titanium				
ZOE®	Nero Black	Acciaio Steel	Oro Gold	Bronzo Bronze	Oro rosa Rose gold	Arcobaleno Rainbow

ANASTASIA / **ARABESQUE** / AUF / **300G.**
COLOR / DOLIUM / **ECLISSE** / FLUTE
MAXIMILIAN / **FIJI** / GLOBO
GOCCIA / FOLD / **LADY LOUIS**
IMPERIAL / **INTI** / LACRIMA / **LUC**
LANTERNA / LOLITA / **PARIGI**
SCARLETT / **SOFFIO** / TAO / **TWIST** / ZOE

CEO

Pietro Tucci

PRODUCT DESIGN

Cangini e Tucci

Alberto Manzoni

Enrico De Lotto

Cristian Li Voi

FOTOGRAFIA

Studio Leon

ART DIRECTION

Leonardi and Partners

STAMPA

Litografia il Papiro

Si ringrazia per la fornitura dei complementi d'arredo:

DUEBI ITALIA

- pag. 37 / 38-39 / 49 / 50-51 / 67 / 73 / 74 / 84-85 / 92 / 94

GIGACER

- pag. 28 / 120 / 132 / 146-147 / 154-155 / 157 / 162 / 168

GERDOMUS

- pag. 98 / 100-101 / 109 / 110-111 / 119 / 121

122 / 130-131 / 158 / 180

- pag. 218 Photo taken in the showroom,
www.luminosfera.pl - ph. Paulina Dabrowska

- pag. 245 www.daslichthaus.com

- pag. 252 Hotel Restaurant de l'Ange - L'Ampoulier

- pag. 253 Lukassen Leuchtenzentrum GmbH,
www.leuchten-lukassen.de

Foto ambientate (articolo Zoe)

- pag. 75 Restaurant Portofino

Light project by www.fliesen-und-wohnambiente.de

- pag. 242, 243 Hotel Mezdi ***S - Visciani Photography

- pag. 242 www.lichtundraum.online

- pag. 244 ADYN. KELLY - e.adynk@me.com

CANGINI&TUCCI S.r.l

Via Archimede, 36

47521 Cesena (FC)

Tel. +39 0547 303035

Fax +39 0547 645146

info@canginietucci.com

www.canginietucci.com

L'azienda si riserva il diritto di apportare modifiche,
atte al miglioramento del prodotto,
in qualsiasi momento e senza preavviso.

*The company reserves the right to make design
changes to improve the products
at any time and without notice.*

 C. CANGINI & TUCCI[®]